

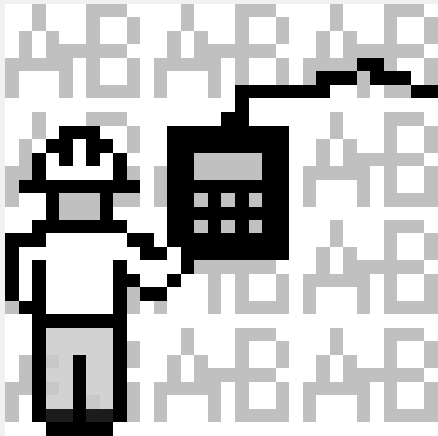

*Allen-Bradley*

*DeviceView  
Configurator*

*(2707-DNC)*



# User Manual

Allen-Bradley HMIs

## Important User Information

Solid state equipment has operational characteristics differing from those of electromechanical equipment. “Safety Guidelines for the Application, Installation and Maintenance of Solid State Controls” (Publication SGI-1.1) describes some important differences between solid state equipment and hard-wired electromechanical devices. Because of this difference, and also because of the wide variety of uses for solid state equipment, all persons responsible for applying this equipment must satisfy themselves that each intended application of this equipment is acceptable.

In no event will the Allen-Bradley Company be responsible or liable for indirect or consequential damages resulting from the use or application of this equipment.

The examples and diagrams in this manual are included solely for illustrative purposes. Because of the many variables and requirements associated with any particular installation, the Allen-Bradley Company cannot assume responsibility or liability for actual use based on the examples and diagrams.

No patent liability is assumed by Allen-Bradley Company with respect to use of information, circuits, equipment, or software described in this manual.

Reproduction of the contents of this manual, in whole or in part, without written permission of the Allen-Bradley Company is prohibited.

Throughout this manual we use notes to make you aware of safety considerations.



**ATTENTION:** Identifies information about practices or circumstances that can lead to personal injury or death, property damage, or economic loss.

---

Attentions help you:

- identify a hazard
- avoid the hazard
- recognize the consequences

**Important:** Identifies information that is especially important for successful application and understanding of the product.

## Table of Contents

<b>Introduction</b>	<b>Chapter 1</b>	
	Equipment and Supplies . . . . .	1-1
	Accessories . . . . .	1-1
	Skills and Knowledge . . . . .	1-1
	Terminology . . . . .	1-2
	Related Publications . . . . .	1-2
<b>How the DeviceView Configurator works</b>	<b>Chapter 2</b>	
	What is a DeviceView Configurator? . . . . .	2-1
	Physical Features . . . . .	2-2
	Display and Keypad . . . . .	2-5
	Operating Modes . . . . .	2-6
	DeviceView Configurator's three editing modes . . . . .	2-6
	Other Functions . . . . .	2-7
	DeviceView Downloader Software . . . . .	2-8
	Editing . . . . .	2-8
<b>Setting up a DeviceView Configurator</b>	<b>Chapter 3</b>	
	Configurator connections . . . . .	3-1
	System Setups . . . . .	3-2
	Installing DeviceView Downloader Software . . . . .	3-4
	Using DeviceView Downloader Software . . . . .	3-5
	EDS files . . . . .	3-6
<b>Running the DeviceView Configurator</b>	<b>Chapter 4</b>	
	Config Mode Menu . . . . .	4-1
	OnLine Setup Mode . . . . .	4-2
	Enhanced (EDS) Mode . . . . .	4-4
	Downloading EDS files . . . . .	4-4
	Using EDS files . . . . .	4-7
	The Image Functions and Parameters Menus . . . . .	4-10
	Basic Mode . . . . .	4-13
	Node Commissioning Mode . . . . .	4-16
	Auxiliary Functions Mode . . . . .	4-19
	Downloading EDS files . . . . .	4-19
	Downloading Operating System files . . . . .	4-19
	Clearing unneeded EDS files from DeviceView Configurator memory . . . . .	4-21
	Setting the Terminating Resistor . . . . .	4-22

**Troubleshooting and  
Maintenance****Chapter 5**

Cleaning the Display Window .....	5-1
Hardware Problems .....	5-2
Operating Problems .....	5-2

**Appendix A****Specifications****Appendix B****Menu Structure****Glossary****Index**

## Introduction

This chapter covers the following topics:

- Equipment and supplies
- Skills and knowledge
- Terminology
- Related publications.

### Equipment and Supplies

The 2707-DNC DeviceView Handheld Configurator comes with this manual: 2707-806 DeviceView Configurator User Manual.

### Accessories

The following cables and power supplies may be used with the DeviceView Configurator:

Catalog No.	Description
2707-NC13	Network cable with bare leads
2707-NC14	Network cable with Micro-connector (Male)
2707-NC15	Network cable with Micro-connector (Female)
2707-NC16	Network power cable
2707-NC8	Upload/download cable
2707-PS120H	120 VAC power supply, AC to DC adapter
2707-PS220	220 VAC power supply, AC to DC adapter

One or more EDS files specific to each device may be loaded into the Configurator. In order to load these files, you will need:

- a 3 1/2" disk with 2707-DP1 DeviceView Downloader Software
- a personal computer with at least 1 megabyte RAM, 4 MEG recommended
- Microsoft Windows 3.1 or better
- an upload/download cable (see above).

### Skills and Knowledge

The **DeviceView Configurator** is designed to configure devices on a DeviceNet system. All configuration options in the DeviceView Configurator are menu driven. Current menus or options appear on the display screen.

To use the DeviceView Configurator you should understand:

- network systems in general and DeviceNet in particular
- how to read printed or electronic EDS files.

**DeviceView Downloader Software** runs on a personal computer under Windows. To use this software you should understand:

- how to use Windows menus
- how to use a mouse (optional).

## Terminology

For unfamiliar terms, refer to the Glossary in the back of this manual.

Conventions used in this manual:

A key on the DeviceView Configurator is referred to

- using bold small capital letters, for instance **HOME**
- using the symbol on the key, for instance ↵.

**Configurator** refers to the DeviceView Handheld Configurator.

**Device** (unless noted) refers specifically to a device that is or will be connected on a DeviceNet network.

**Downloader software** is the DeviceView Downloader Software installed in a personal computer. It may be used to download EDS files or an Operating System file to a DeviceView Configurator.

**EDS file** is an Electronic Data Sheet supplied by the device manufacturer that contains information about a device.

**Operating system (OS)** is the firmware for the DeviceView Configurator. Future updates of the firmware can be downloaded to DeviceView using the Downloader software.

## Related Publications

The DeviceNet Specification manual is Part No. 956166, Catalog No. D9240-DNDOC.

- DeviceNet Specification. Volume I: *DeviceNet Communication Model and Protocol* Open DeviceNet Vendor Association, Inc., Coral Springs FL © 1994.
- DeviceNet Specification. Volume II: *DeviceNet Device Profiles and Object Library* Open DeviceNet Vendor Association, Inc., Coral Springs FL © 1994.

# How the DeviceView Configurator works

This chapter covers the following topics:

- What is a DeviceView Configurator?
- Physical features
- Display and keypad
- Functions of a DeviceView Configurator
- Other functions
- DeviceView Downloader Software.

## What is a DeviceView Configurator?

A DeviceView Configurator is a hand-held device that can configure individual devices on a DeviceNet network.

Devices on a DeviceNet network are often configured using a personal computer with a configuration program and a DeviceNet interface. A DeviceView Configurator provides an alternative.

The DeviceView Configurator communicates with and configures:

- devices on a DeviceNet network
- devices that will be connected to a DeviceNet network at a later time.

Use the keypad on the configurator to respond to a set of linked menus and commands displayed by the configurator.

### DeviceNet network

The DeviceNet network provides both signal and power connections to devices in a system. The network usually contains a logic controller, which sends information to other devices on the network and receives information from them. These devices may include starters, bar code scanners, controllers, input/output devices and PLCs.

## Configuring devices

All the devices on the network should be able to communicate with one another. This means that:

- all devices must be set to the same baud rate
- each device must have a unique address on the network.

In addition, each device may have other parameters that allow it to do its task in running the operation. Those parameters are determined by the device manufacturer, and provided either as an EDS file or on paper.

Devices may be configured in either of two ways.

- Some devices use DIP switches, jumpers or other hardware settings. The settings must be adjusted by hand.
- Some devices have parameters that can be set by software. Those parameters may be configured using a DeviceView Configurator.

## Physical Features

The DeviceView Configurator has on its front face:

- a 2 line by 16 character display where the current information or option is displayed
- a keypad to change the display or enter a value.

The keypad is separated by color into easily identified groups or functions.

Color:	Key:	Is used to:
Black	1-9, 0	enter a value.
	.	place a decimal point as the value is entered.
	+/-	enter a negative number, toggle a value between positive and negative, or toggle a bit between 0 and 1.
Dark Grey	CE (Clear Entry)	clear the field in which data is being entered, setting it to 0 or to the field's minimum value.
	▲ (Increment) or ▼ (Decrement)	display the last or next: <ul style="list-style-type: none"> <li>• entry in an enumerated data type</li> <li>• value in a data entry screen</li> <li>• bit number being viewed in a bit field.</li> </ul> These keys may be held down for auto-repeat to allow you to sequence rapidly to the desired value.
Blue	HOME	display the Home Menu by exiting the current function without saving it.
	NEXT or PREV	scroll forward or backward in a scrolling menu.
Light Grey	*	(Has no function in the current revision.)
	↵ (Enter)	accept the displayed choice and move to the next logical step in the process or enter the modified value when editing attributes in Enhanced Mode.



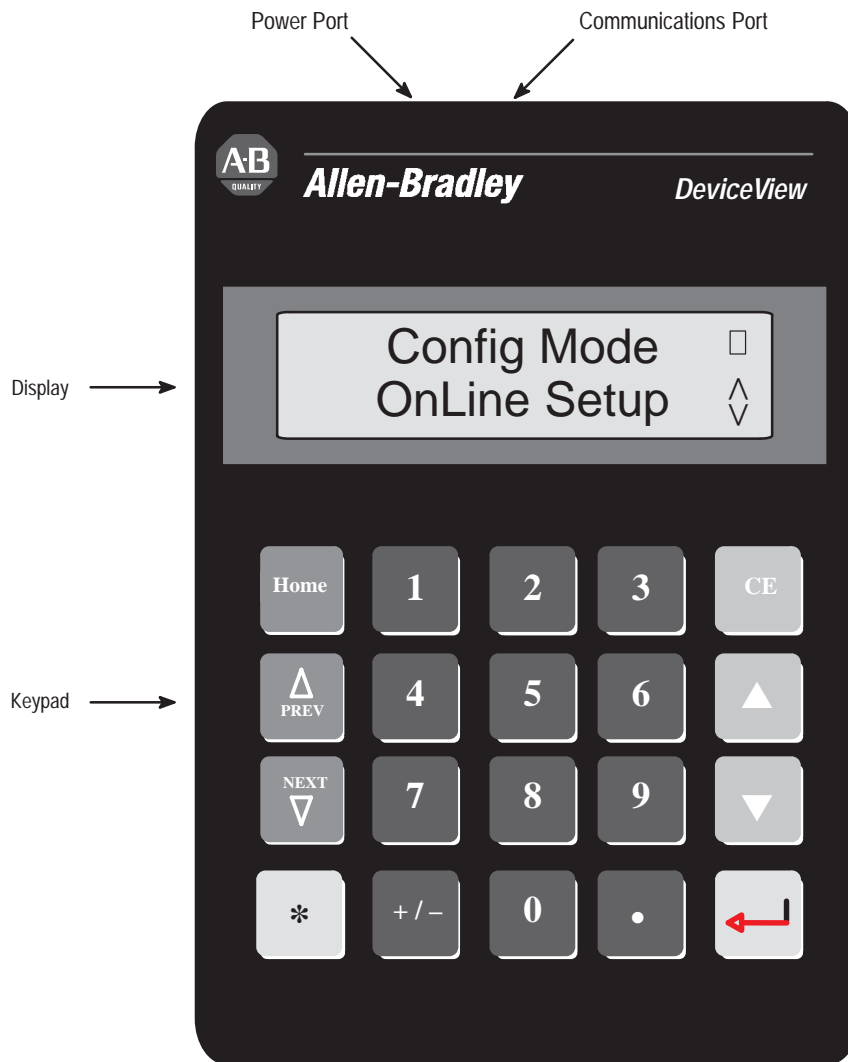
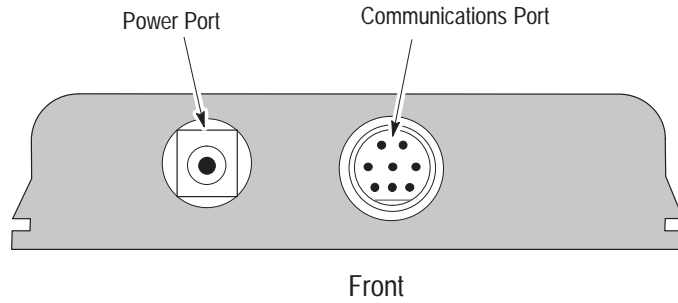

# Allen-Bradley HMIs

It also has two ports:

- a communications port to connect the configurator to a device, a network or a personal computer

This port has an RS-232 channel, a DeviceNet channel and a power connection. The DeviceNet Configurator gets its power through this port when it is connected to a DeviceNet network.

- a power port

The power port is a 2-conductor power jack used to connect an external 11 to 25 VDC power source to the configurator when it is not connected to a DeviceNet network.

### **Communications**

Connect the DeviceView Configurator Communications Port to one of the following:

- a DeviceNet network through which it can send to a selected device the data needed to configure it for the system
- an individual device to set:
  - only the baud rate and node address, or
  - all the data needed to configure it.
- a computer with DeviceView Downloader Software installed, from which it can download EDS or Operating System files over an RS-232 channel.

Communication and power connections are described and illustrated starting on Page 3-2.

## Display and Keypad

The upper line in the display depends on the status of the configurator. The lower line lists options, reports on what action is going on, or indicates a choice that the user can make.



### The upper line may:

- give the title of the menu
- indicate the present status
- provide options.

Conventions used in the display upper right corner:

- – hollow block indicates that the configurator is in OffLine mode
- – solid block indicates that the configurator is in OnLine mode
- E – indicates an error
- ∞ – indicates that the configurator's DeviceNet interface is in a "Bus off" condition.  
**Note:** This may indicate the baud rate is incorrect and may be accompanied by a Fail message.

### The lower line gives a variety of options

- ∧  
∨ – When the display has a hollow up/down arrow, the displayed command option may be:
  - changed by pressing the **PREV** or **NEXT** key, or
  - accepted by pressing the ↵ key.
- ▲  
▼ – When the display has a solid up/down arrow, the displayed value may be:
  - changed by pressing the Increment/Decrement keys, or
  - accepted by pressing the ↵ key.
- When a flashing cursor is on a number, that number may be:
  - edited by pressing numeric keys, the Increment/ Decrement keys, the **CE** key, the decimal point key, or the +/- key, or
  - accepted by pressing the ↵ key.
- When a ↵ symbol is displayed, press the ↵ key to go to the main menu or some other option not covered by the above symbols.
- When no option is given, wait until the configurator has finished with its current process and a new display appears.

**To access a different mode:**

1. Return to the main menu.
2. Press the **PREV** or **NEXT** key until the mode is displayed.
3. Press the ↵ key.

## Operating Modes

The five modes are:

- OnLine Setup Mode
- Enhanced (EDS) Mode
- Basic Mode
- Node Commission Mode
- Aux Functions Mode.

The configurator can perform a variety of tasks. It can:

- download EDS files from a personal computer into its flash memory (in Aux Functions mode)
- display each parameter from a device's EDS file so the operator can edit it using the keypad (in Enhanced mode)
- allow the operator to select and edit parameters from the device itself without an EDS file (in Basic mode).
- locate a specific device on the network and change configuration data in its memory (in Enhanced or Basic mode)
- set baud rate and node address for a device connected point-to-point, in a few seconds (in Node Commission mode)
- perform housekeeping tasks (in Aux Functions mode)

### DeviceView Configurator's three editing modes

In **Node Commissioning Mode** the configurator sets only the baud rate and node address for a device connected point-to-point. See Page 4-16 for step-by-step instructions.

**Note:** This mode should not be used when the DeviceView Configurator is connected to a network.

In **Basic Mode**, the configurator can display and modify *adjustable* attribute values in a selected device on a DeviceView network. See Page 4-13 for step-by-step instructions.

In **Enhanced Mode**, the user must download an EDS file from a personal computer to the configurator for each device that will be configured. Then a device on a DeviceNet network is selected and configured according to the EDS file parameters. See Page 4-4 for step by step instructions.

**Note:** An EDS file is a specially formatted ASCII file supplied by the device manufacturer. It:

- describes each parameter, including its name and default value
- provides a range of settings for each configurable parameter.

Refer to the DeviceNet Specification for a complete discussion of EDS File requirements.

## Other Functions

The **EDS Download** function allows the operator to download a number of EDS files one at a time. The DeviceView Configurator has 62K of flash memory reserved for EDS storage. This memory can hold up to 31 EDS files, depending on how large they are. Typical files are about 4K. See Page 4-4 for step-by-step instructions.

If the configurator's flash memory is full, a message appears on the computer screen and on the configurator's display, and the download is aborted. EDS files are never overwritten.



Memory Full  
Download Aborted ↵

The **Operating System Download** function allows the operator to replace the operating system with a new version. Operating System Download is rarely used, since the DeviceView Configurator comes with the current operating system version installed and ready to use. However, Allen-Bradley may produce a diskette with an updated operating system. See Page 4-19 for step-by-step instructions.

The **EDS View/Delete** function allows the operator to mark and purge EDS files in its flash memory, to make room for new files to be downloaded. See Page 4-21 for step-by-step instructions.

The **OnLine Setup** function is required before the DeviceView Configurator can access a DeviceNet Network. It makes the configurator active on the network with the CAN (Controller Area Network) chip enabled. See Page 4-2 for step-by-step instructions.

If the baud rate and/or node address are changed, the operator is given the option of saving the changes in flash memory. The values in flash memory will be the default values the next time the DeviceView Configurator is powered up.

## DeviceView Downloader Software

A DeviceView Configurator requires DeviceView Downloader Software. When this Software is installed on a personal computer it may be used to download:

- EDS files, which have extension .EDS (see Page 4-4)
- an operating system firmware file used to update the configurator, which has extension .HEX (see Page 4-19).

The DeviceView Configurator has core code firmware in ROM. This core code:

- performs power-up diagnostic tests
- passes control to an operating system
- supports downloading of an operating system file from a personal computer.

The operating system in flash memory performs all the other tasks summarized in this chapter and discussed in the manual.

## Editing

All editing changes take place on an image of the data in the configurator's RAM. The edited image may be sent to a device or stored in the configurator's flash memory or both.

### Saving edited values

The operator can send parameter values to the device from the image in the configurator's RAM:

- one at a time (Enhanced and Basic Modes)
- all together in the form of the RAM image at the end of the session (Enhanced and Node Commissioning Modes).

Every time the operator sends a modified value or file to a device, the requested change must be confirmed. The following message will appear on the DeviceView display:

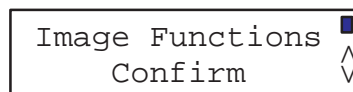

- Press the ↵ key to confirm the changes.
- Or press the **NEXT** or **PREV** keys to leave the device's configuration unchanged and move to another option.

**Note:** In Enhanced mode, the values may also be saved to the stored EDS file, replacing the original values.

**Exiting from a function:**

- Press the **HOME** key to return to the Home Menu.
- Or display the Done command (if it is available in the current function) by using the **PREV** or **NEXT** key, and select it by pressing the **↵** key.

The configurator is usually online, so when it returns to the Home Menu it defaults to the Enhanced mode. If it is offline, it defaults to the OnLine Setup mode.

```
Config Mode ■
Enhanced (EDS) ^
```

```
Config Mode □
OnLine Setup v
```

## Setting up a DeviceView Configurator

This chapter covers the following topics:

- Configurator connections
- Safety guidelines
- System setups
- Installing DeviceView Downloader Software
- Using Downloader Software.

### Configurator connections

Connect the DeviceView Configurator to one of the following three sources of DC power:

- a DeviceNet network through the cable connected to the Communication Port
- a DeviceNet network power cable
- a separate DC power source connected to the Power Port, whenever the Communication Port is connected to a PC for program transfers or to a device that has not yet been connected to a DeviceNet network.



**ATTENTION:** Only one DeviceNet device should be connected to the DeviceView communications port when using the DeviceView power supply or network power cable. The DeviceView Configurator does not provide any current limiting.

---

Connect the DeviceView Configurator Communications Port to one of the following:

- a DeviceNet network
- an individual device
- a personal computer.



## System Setups

When the Communications port is connected to a computer or a device that is not on the network, connect the Power port to one of the following:

- a DC power supply or
- a DeviceNet network (using a network power cable).

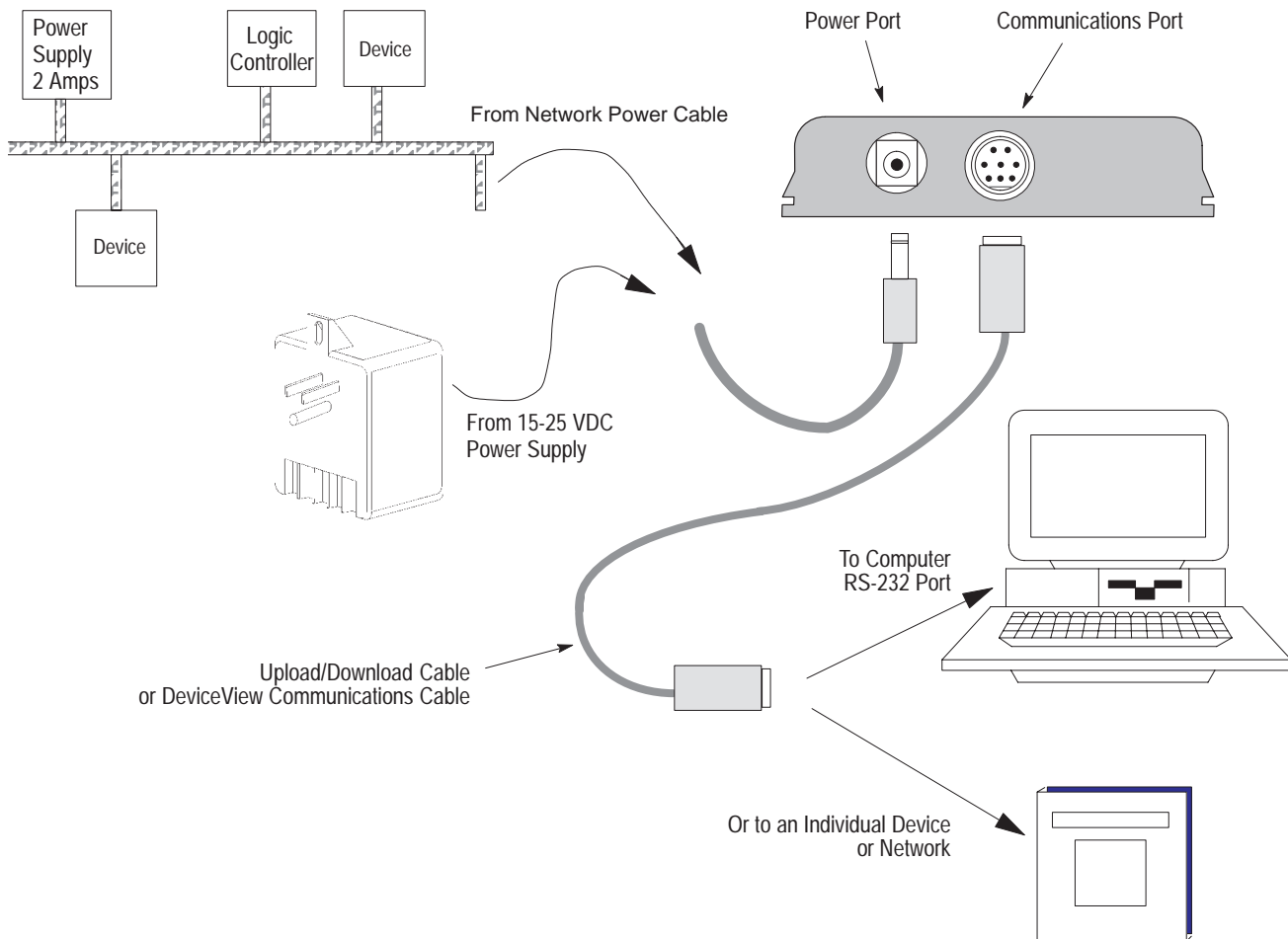

You can use any of the DeviceView accessories listed in the table on page 1-1.

When the configurator is connected to a DeviceNet network, it gets its power through the same cable that provides two-way communication:

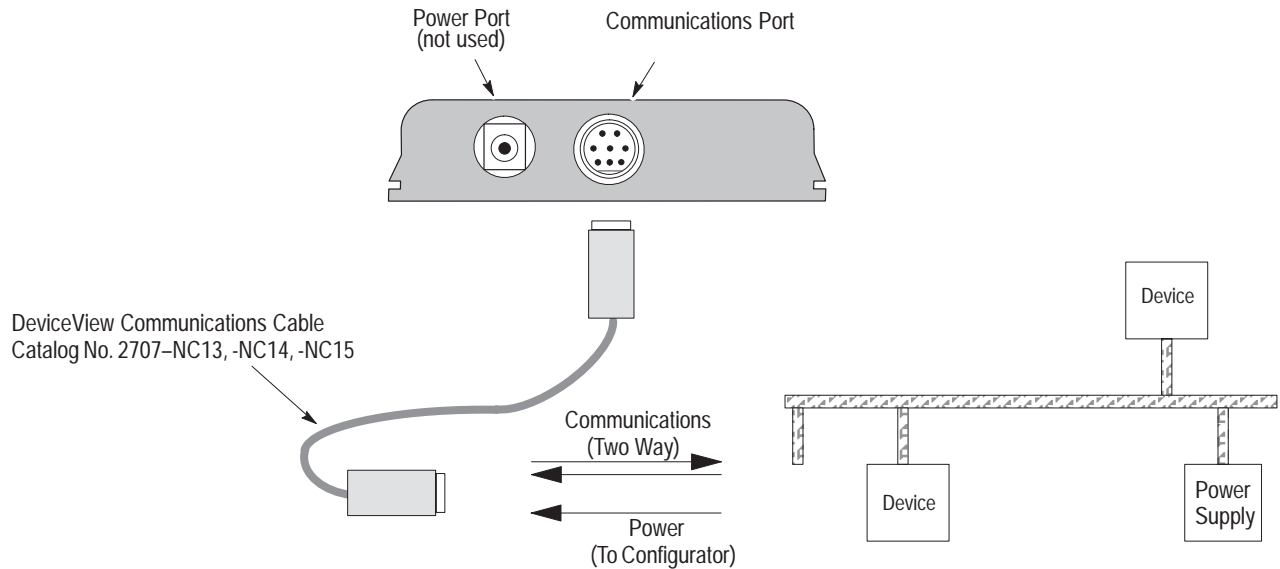

### Summary of connections

The DeviceView Configurator may be connected in three ways.

Connect to:	Purpose	Communications Port	Power Port
Personal computer	Download EDS and Operating System (OS) files	To computer RS-232 port	To DC power source
Any device not yet connected to the network	1. Configure device 2. Set baud rate and node address	Point-to-point to the DeviceNet port on the device	To DC power source - or - To network power using a network power cable
DeviceNet network	Configure devices on the network	To a tap on the network	(none)

## Installing DeviceView Downloader Software

The DeviceView Downloader Software must be installed on the hard drive of your computer.

1. Start Windows.
2. Insert the downloader software disk in the floppy drive. For purposes of these instructions we call it Drive A.
3. Double-click on File Manager, then click on the **A:** drive.
4. Double-click on the **SETUP.EXE** file.
5. A DeviceView Setup screen appears. In a few seconds it is replaced by:



6. Select Continue to accept this directory.  
Or highlight the directory and type in a different destination directory.  
Or select Exit to abort the installation procedure.
7. An interim screen shows the progress of the installation. Then the new program group appears.

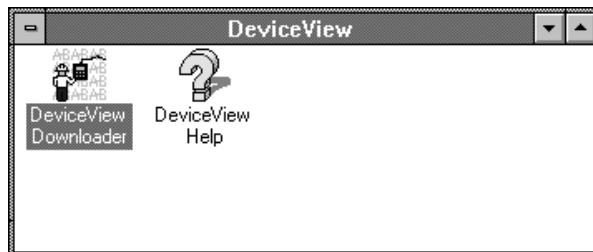

8. Double-click on the DeviceView Downloader icon to open the program.  
Or double-click on the Help icon to open the Help Table of Contents.

**Note:** A subdirectory was created during installation to contain EDS files. However, the DeviceView Downloader Software can find these files anywhere if the path is specified.

## Using DeviceView Downloader Software

Before starting to download:

1. If necessary, delete some EDS files in the DeviceView Configurator to make room for the new ones (see page 4-21).
2. Put the DeviceView Configurator into EDS Download Mode (see Page 4-4).
3. Connect the Communications port on the configurator to the RS-232 port of the computer.
4. Connect the Power port on the configurator to a DC power supply.

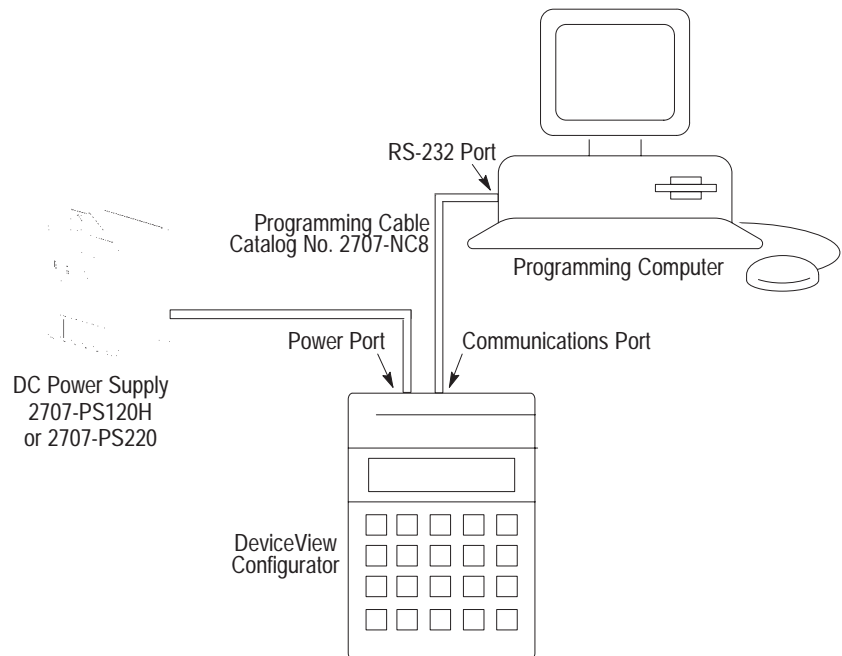

5. Double-click on the DeviceView Downloader icon to open the main window:



### Downloading

See the section starting on Page 4-4 which gives step-by-step procedures for downloading EDS files to the DeviceView Configurator and using them.

See the section starting on Page 4-19, which gives step-by-step procedures for downloading OS files to the DeviceView Configurator

### To set the computer RS-232 port:

- Click on the Select Port command to display the Select Port dialog.

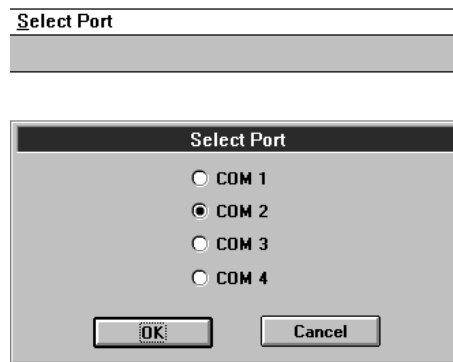

- The current port has a dot in its radio button; if it is correct, click either OK or Cancel  
If necessary, click on a different Com port number and click OK.

### EDS files

EDS (Electronic Data Sheet) files are supplied by the device's manufacturer. If only a printed page is sent with the device, an EDS file may be created on the computer using any text editor or word processor that can edit ASCII text files.

## To access Help



- Click the Help icon, then click on an item. A context-sensitive Help screen will appear.
- Or select a command on the Help menu:
  - click on **C**ontents... to bring up an index of DeviceView Downloader Software Help Contents
  - click on **U**sing Help... to bring up an index on how to use Help
  - click on **A**bout DeviceNet Downloader... to view the version number and copyright date of the downloader software.

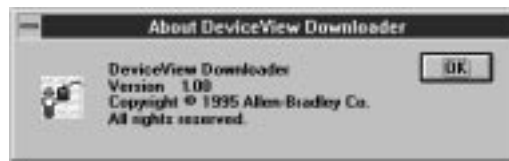

**Note:** Be ready to give the version and date if you have to call Allen-Bradley for assistance with the downloader software.

## Running the DeviceView Configurator

This chapter covers the following topics:

- Config Mode Menu
- OnLine Setup Mode
- Enhanced (EDS) Mode
- Basic Mode
- Node Commissioning Mode
- Auxiliary Functions Mode.

### Config Mode Menu

The DeviceView Configurator has six modes of operation. Five of them are accessed through commands on the Configuration Mode menu. Each mode has submenus and commands for its own set of functions.



Cycle through these commands by pressing the **PREV** or **NEXT** key until the desired one is displayed, then press the **↵** key.

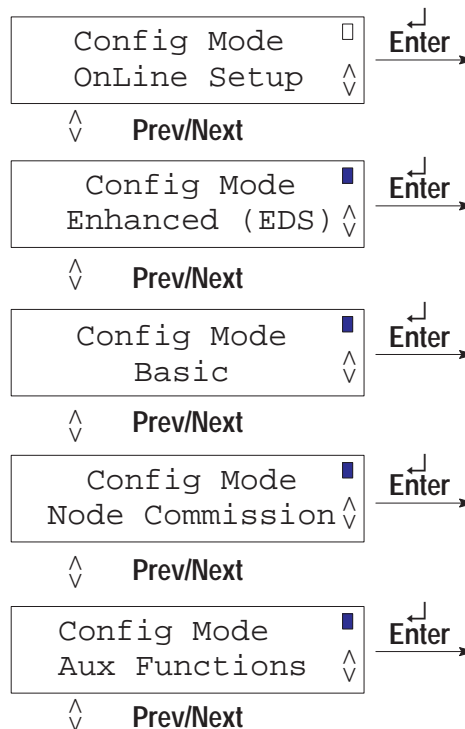

Displays that require a response have either:

- a symbol in the lower right corner to indicate the key to press
- a flashing cursor where a data entry choice is to be made

## OnLine Setup Mode

First configure the DeviceView Configurator itself so it can communicate with other devices.

OnLine Setup is the menu default when the configurator is offline. It appears when:

- the DeviceView Configurator is powered up
- the system resets, for instance after an operating system is downloaded.

### To set up the DeviceView Configurator:



1. Use the **PREV** or **NEXT** key if necessary to cycle through the main menu until the OnLine Setup command is displayed, and press the ↵ key.

```

Config Mode  □
OnLine Setup  ^
  
```

This display appears while the Autobaud function is checking the DeviceNet baud rate:

```

AutoBaud Rate  □
Detect...Abort  ↵
  
```

2. To abort the procedure, press the ↵ key before a baud rate is displayed. Otherwise, wait until the next display appears.
3. The DeviceView Configurator displays the detected or default baud rate with a flashing Increment/Decrement symbol. Change the baud rate as required by cycling through the values with the Increment or Decrement key, and press the ↵ key.



```

DeviceNet Port  □
Baud Rate: 125 kb  ▲▼
  
```



**ATTENTION:** Changing this value overrides the value determined by Autobaud. If the DeviceView Configurator is connected at the wrong baud rate for the network, it will cause network errors.



4. The DeviceView Configurator displays the default node address with a flashing cursor over it. To change it:

- enter a number (0 to 63) from the keypad. or
- use the Increment or Decrement key to display other numbers in sequence.

```
Configurator □
Node Addr: 61
```

To accept the displayed address, press the ↵ key.

**Note:** The following screen will appear if either or both settings are changed from the default:

```
Setup Changed □
Save Changes  ^
```

Press the ↵ key to select Save Changes and save the settings as the default for the next powerup.

Or press the NEXT key and the ↵ key to select Continue. This maintains the previous default settings in memory but allows the DeviceView Configurator to go online with the changed settings.

5. The DeviceView Configurator checks the current address setting using the DUP MAC (Media Access Control) ID test. This test determines if the address is unique in the network.

If the test is successful, the address and baud rate are displayed and the DeviceView Configurator is placed online. Note that the box in the upper right corner is now filled, indicating that the DeviceView Configurator is online:

```
OnLine Success ■
Node:61 125kb ↵
```

If it fails, an error message appears. Note that the box in the upper right corner is replaced by an E, for Error.

```
DUP MAC ID Fail E
Continue ↵
```

6. Press the ↵ key to return to the OnLine Setup command.
7. Go through the steps again, but select an address that is different from any device on the attached network.

## Enhanced (EDS) Mode

This mode is the simplest way to configure devices on a network. See Page 3-2 for a summary of the different device configuration modes.

### Downloading EDS files

#### Set up the DeviceView Configurator:

1. Connect the DeviceView Configurator Communications port to the serial port of the personal computer. Connect the power port to a 11-25 VDC power source. See Page 3-5.

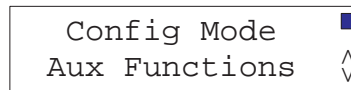

2. Use the **PREV** or **NEXT** key to cycle through the Config Mode menu until Aux Functions Mode is displayed. The first command on the Aux Functions submenu is EDS Download.



3. Press the **↵** key. The display reports:



#### Start the DeviceView Downloader Software in the personal computer.



1. Click on the EDS icon on the toolbar to open the Open dialog. Or click on the Choose Download menu, then click on the Download EDS File command.

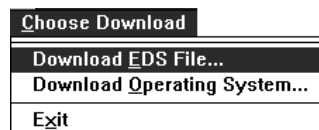



5. Check that the DeviceView Configurator display reads Waiting, then select Continue in the personal computer. The EDS file is downloaded into the DeviceView Configurator's RAM, then copied into flash memory.



EDS File  
Download Done ↵

**Note:** If you like, you can download the same file from the personal computer several times, each time with a different configuration identifier. Edit parameter settings in each one for a different configuration and save the files. Then when a device configuration is needed in another system, its values are already set up.

If there is a problem with the download, an error message appears.

- some problems are fatal, and the download aborts.
- other problems give a warning, but the download may continue.

If the DeviceView Configurator's EDS flash memory has too little room for the new file, the display reads:

Memory Full ■  
Download Aborted ↵

In this case, one or more of the EDS files in DeviceView Configurator memory will have to be deleted before any new files can be loaded. See Page 4-21.

6. Press the ↵ key to return to the Aux Functions submenu.

Or press the HOME key at any time to abort the download and return to the Enhanced (EDS) menu option.

## Using EDS files

To select a device on the network:

1. Connect the DeviceView Configurator Communications port to a DeviceNet network and go through the OnLine Setup procedure.

```

Config Mode      ■
Enhanced (EDS)  ^
  
```

2. Enhanced (EDS) Mode is the default main menu display when the DeviceView Configurator is online. If necessary use the **PREV** or **NEXT** keys to cycle through the main menu choices until it appears. Press the **↵** key. In the Device Address display the value has a flashing cursor over it.

^  
v

```

Device Address  ■
Node: 0
  
```

3. Select a device by entering its node address using the keyboard numbers or the Increment/Decrement keys. Press the **↵** key. The DeviceView Configurator displays the name of the device at that address. For example:

▲  
▼

```

Device Present  ■
2705T          ^
  
```

If it is not the desired device, press the **NEXT** key and the **↵** key to select Next Device. The DeviceView Configurator looks for the next active node.

4. If no device is at that address, this message appears:

```

No Device Found ■
Next Device    ^
  
```

- Press the **↵** key to select Next Device. The DeviceView Configurator tries each node in turn starting with the next higher number, looking for a node with a device.
- Or press the **NEXT** key and the **↵** key to select CONTINUE to continue Enhanced Mode operation without an attached device. Options that require a device connection will not be available in this case.

To select an EDS file that matches the device:

```
Device Present  ■
                2705T  ^
                2705T  v
```

1. When a device is located, its embedded Product Name is displayed. Press the ↵ key to call up the corresponding EDS file so it is loaded into RAM. The file must match the device in its:
  - product type
  - product code
  - vendor ID.
2. If a matching EDS file is found its name is the first selection displayed.

```
EDS File Select  ■
                 RediStation{1} ^
                 RediStation{1} v
```

- press the ↵ key to accept it, or
  - use the **PREV** or **NEXT** key to cycle through the names until the desired one is displayed, and press the ↵ key.
3. If the EDS file matches the selected device, the Image Functions menu appears (see below). If the EDS file does not match the selected device:

^  
v

```
EDS MisMatch  ■
Enter New EDS  ^
Enter New EDS  v
```

- press the ↵ key to return to the EDS file list and select a different file
- if necessary, download an EDS file that matches the device
- or press the **NEXT** key and the ↵ key to select Continue and go to the Image Functions menu.



**ATTENTION:** If the operator selects a file that does not match the device, configuration errors may occur.

**To select an EDS file with no device chosen:**

An EDS file may be selected and edited even when no device has been found or the DeviceView Configurator is in OffLine mode.

1. Use the **PREV** or **NEXT** keys to move through the main menu to the Enhanced (EDS) option. Note that the box in the upper left of the display is hollow unless OnLine Setup has been run.

```
Config Mode  □  
Enhanced (EDS)  ▾
```

2. Press the **↓** key to get to the EDS File Select display.

```
EDS File Select  □  
Generic-V1.00  ▾
```

^  
v

3. Use the **PREV** or **NEXT** key to display each EDS file in the DeviceView Configurator flash memory in turn. When the correct one is displayed, press the **↓** key. The Image Functions menu will be displayed.

**Note:** Options that require a device connection will not be seen.

4. Press the **Next** key and the **↓** key to select Continue and go to the Image Functions menu.

## The Image Functions and Parameters Menus

Configure the device using the Image Functions menu and the Parameter submenu. All editing on an image of the EDS file is done in volatile memory. Use commands in the Image Functions menu to send the edited file to the device, and to store it in flash memory.

To set parameters:

```
Image Functions  ■
Get From Device  ⬆
```

1. First load the initial data image:

- press the  $\downarrow$  key to select Get From Device to use the parameter data presently in the device
- or use the NEXT key to display Get From File, and press the  $\downarrow$  key to use parameter data from the EDS file

2. The View Parameters screen appears. Press the  $\downarrow$  key to access parameter Groups.

```
Image Functions  ■
View Parameters  ⬆
```



3. The flashing cursor is on the Increment/Decrement keys symbol. Cycle through the list of Group names and press the  $\downarrow$  key to select one. Then repeat with the list of Parameter names in that group.

**Note:** The lists of Group Names and Parameter Names are specific to the device being configured.

```
Enter Group:  ■
IO Assembly  ▲▼
```

```
Enter Param:  ■
Input Data  ▲▼
```

4. Edit each parameter separately. The flashing cursor is on the value that can be edited:

```
Input Data  ■
Input 1    : 0  ⬆
```

**Note:** In data entry screens, you must press the  $\downarrow$  key to accept the edited value.



For each parameter:



- to get the value from the device, select Val from Device in this menu
- to get the value from the DeviceView Configurator file, select Val from File in this menu.

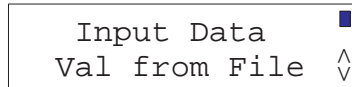

Edit the value according to this table:

If the value is:	Then:
Numeric Type	Use the number keys, the +/- key, or the decimal (.) key on the keypad to enter a value Or use the Increment or Decrement keys to change the value Or use the CE key to clear the display.
String of Bytes	Displays up to four bytes which can be edited in sequence using the numeric keys (see Basic Mode display)
Bit Enumeration Type	Use the Increment or Decrement key until the correct bit name appears, and then use the +/- key or the 0 and 1 keys to toggle between 0 and 1
Enumerated Type	Use the Increment or Decrement key until the correct text string appears.

5. Usually the whole parameter image is sent to the device at once, see below. However,

- if the data were uploaded from the device (Step 1 above, Get From Device), and
- if only one or two parameters have to be changed,

then each parameter may be sent when it is edited. Press the **NEXT** key until Val to Device appears, then press the ↵ key. This display appears:

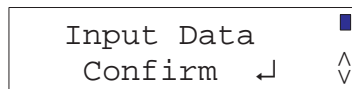

Press the ↵ key again.

**Note:** Whenever a value or parameter image is sent to a device, the operator must confirm the change.

6. When all values are correct, use the **PREV** or **NEXT** key and the ↵ key to select another parameter in the same group, or another group for the same device.



7. When all editing is finished for this device, use the **PREV** or **NEXT** key to display the Image Functions option. Press the **↵** key to return to the Image Functions menu.

```

Input Data   █
Image Functions ^
  
```

**To save the Parameter Image file:**

^  
v

Use the **PREV** or **NEXT** key to cycle through the Image Function menu choices. Press the **↵** key to select one of the following:

- Save To Device sends the edited Parameter Image to the selected device. Press the **↵** key again to confirm the operation.

```

Image Functions █
Confirm       ↵
  
```

- Save To File stores the edited Parameter Image in the DeviceView Configurator's non-volatile memory
- Set To Defaults sets the Image to default values specified in the EDS file
- New Device returns to the Device Address display. Enter a different node address and select another device for editing.

**To exit from Enhanced Mode:**

- use **DONE** to return to the Enhanced (EDS) option on the main menu.
- or use the **HOME** key at any time to abort the current function and return to the Enhanced (EDS) option on the main menu.

## Basic Mode

The DeviceView Configurator's Basic Mode may be used if any of the following applies:

- no EDS file is available for the device
- the correct EDS file is not loaded
- the operator wants to work with parameters that were not called out in the device's EDS file.

**Note:** The values selected or entered in Basic Mode may be sent to or retrieved from a device, but edited values are not stored in the DeviceView Configurator's memory.

Each parameter is defined by its DeviceNet Class, Instance, and Attribute number, which are specified by the manufacturer.

- The Class number identifies an Object Class.
- The Instance number identifies the particular occurrence of that object within a device. A device may have a number of instances of the same object class.
- Attributes are parameters that are part of this Object Class. They may be Class Attributes or Instance Attributes. Attributes are the editable values in a class or instance.

As an example, the Identity Class is Class 1. Within that Class, Instance 1 Attribute 7 is the device's serial number as specified by the DeviceNet specification.

### To select a device on the network:

1. Connect the DeviceView Configurator Communications port to a DeviceNet network and go through the OnLine Setup procedure.

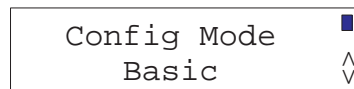

A rectangular box containing the text "Config Mode" on the top line and "Basic" on the bottom line. To the right of the text is a small blue square above a diamond-shaped cursor.

^  
v

2. Use the **PREV** or **NEXT** keys to cycle through the main menu choices until Basic appears. Press the ↵ key.
3. In the Device Address display the value flashes.

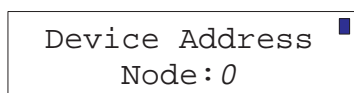

A rectangular box containing the text "Device Address" on the top line and "Node: 0" on the bottom line. To the right of the text is a small blue square.

Select a device by entering its node address using the keyboard numbers or the Increment/ Decrement keys. Press the ↵ key.



4. The DeviceView Configurator displays the embedded product name of the device at that address.

```
Device Present
      2705T
```

If it is the desired device, press the ↵ key to configure it; see below.

If it is not the desired device, press the **NEXT** key and the ↵ key to select New Device. The DeviceView Configurator looks for the next active node.

5. If no device is at the address, this message appears:

```
No Device Found
      Next Device
```

- Press the ↵ key to select Next Device. The DeviceView Configurator tries each node in turn starting with the next higher number, looking for a node with a device.
  - Or press the **NEXT** key and the ↵ key to select **DONE** to return to the main menu.
6. When a device is located, a Product Name is displayed. Then:
- press the ↵ key to accept the displayed device
  - or press the **NEXT** key and the ↵ key to search for another device at a different node address.

#### To configure a device using Basic Mode:

When a device is located, its embedded Product Name is displayed. Press the ↵ key. The flashing cursor is on the value in the next three choices. Change the value by using the numeric keys or the Increment/Decrement keys.

1. Enter a value representing the parameter's Class ID and press the ↵ key.

```
Enter Class
      ID: 1
```

2. Enter the Instance Number and press the ↵ key.

```
Enter Instance
      Number: 1
```

3. Enter the Attribute Number and press the ↵ key.

```
Enter Attribute
Number : 7
```

The next display screen has the specified three values as the top line. It is similar to the Parameter menu in Enhanced (EDS) Mode.

```
C001  I001  A007
5   |50   |55   |48
```

The value is displayed as a series of one to four bytes separated by vertical bars.

### To configure the attribute

1. The flashing cursor is on the first byte on the left. Use the numeric keys to enter a new value if required and press the ↵ key. The flashing cursor moves to the next byte. Enter a new value and press the ↵ key. Repeat with the remaining bytes.  
Or press the **NEXT** key to display Val **From** Device and press the ↵ key. The attribute display appears and can be edited as above.
2. Use the **NEXT** key to display Val **To** Device and press the ↵ key to send the edited attribute to the device.

```
C001  I001  A007
Confirm  ↵
```

3. Press the ↵ key to confirm the value.

Some attributes are fixed (non-settable), but others may be configured. Bring up the configurable attributes one at a time, using information from the manufacturer's printed data sheet.

- For the next attribute in the current class and instance, use the **NEXT** key to display Change Attrib and press the ↵ key to return to the Enter Attribute Number display.  
Enter the number of the new attribute and press the ↵ key.
- For the next instance in the current class, use the **NEXT** key to display Change Instance and press the ↵ key to return to the Enter Instance Number display.  
Enter the new instance number and press the ↵ key.  
Enter an attribute number for this instance, press the ↵ key, and enter its value.

- for the next class, use the **NEXT** key to display Change Class and press the **↵** key to return to the Enter Class Number display.  
Enter the new class number and press the **↵** key.  
Enter an instance number for this class and press the **↵** key.  
Enter an attribute number for this instance, press the **↵** key, and enter its value.

Then select or enter the value for each attribute in turn. Repeat until all configurable attributes have been checked.

**To exit from the Basic Mode menu:**

- use the **NEXT** key to display Next Device, and press the **↵** key  
The Device Address Node display comes up. Enter a different node number to select another device.
- or use the **NEXT** key to display DONE, and press the **↵** key to return to the main menu.
- or use the **HOME** key at any time to abort the current function and return to the main menu.

## Node Commissioning Mode

Use this mode when only the baud rate and node address of a device are to be configured. A commissioned device may be put on a network later.



**ATTENTION:** Do not use this mode when the DeviceView Configurator is connected to a network. This mode should only be used in point-to-point connections with a single device.

**To commission the device for a network:**

1. Connect the DeviceView Configurator Communications port to a device's DeviceNet port. Connect the Power port to an 11-25 VDC power source. See Page 3-2.
2. Check that the Termination Resistor is In. See Page 4-22.
3. Place the DeviceView Configurator OnLine.
4. Use the **PREV** or **NEXT** key to cycle through the main menu until Node Commission is displayed, and press the **↵** key.

```

Config Mode  ■
Node Commission  ^

```

5. In the Device Address display the value has a flashing cursor.

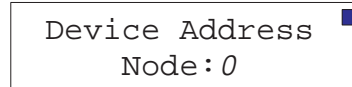

```
Device Address
Node: 0
```

6. Select the device by entering its node address using the keyboard numbers or the Increment/ Decrement keys. Press the ↵ key. The DeviceView Configurator displays the name of the device at that address.

**Note:** Most devices use node address 63 for out-of-box default.

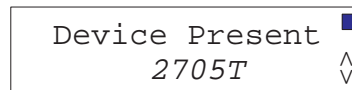

```
Device Present
2705T
```

7. If no device exists at this address, a message appears:



```
No Device Found
Next Device
```

- Press the ↵ key to select Next Device. The DeviceView Configurator tries each node address in turn starting with the next higher number, looking for the address currently set in the device.
  - Or press the NEXT key and the ↵ key to select DONE, to return to the main menu.
8. When the device is located, its Product Name is displayed. Press the ↵ key to select it.
9. The Node Address display shows the default node address. The flashing cursor is over the value on the second line. Enter a new address (0 to 63).



```
Node Address:15
Change To:23
```

**Note:** If a number of devices are being commissioned, the default address is the last address entered, plus 1. Thus if the last device commissioned was at address 22, the current default is 23.

- 10.** The Baud Rate display shows the current baud rate. Use the Increment/Decrement keys to cycle through the values to the desired one. Then press the ↵ key to send the new settings to the device.

```
Baud Rate: 125kb █
Change To: 125kb ▲▼
```

If the device was successfully updated, the new settings are displayed. Press the ↵ key

```
Update Success █
Node: 23 125kb ↵
```

If the update failed, this display appears. Press the ↵ key.

```
Update Failed █
Continue ↵
```

- 11.** In either case, the Node Commission screen appears.

```
Node Commission █
Next Device ▲▼
```

To commission another device, connect it to the DeviceView Configurator in place of the one just commissioned, and press the ↵ key.

To return to the main menu, use the NEXT key to display DONE and press the ↵ key.



## Auxiliary Functions Mode

Use this mode to download files from a personal computer, and to perform housekeeping tasks in the DeviceView Configurator.

Press the **HOME** key at any time to exit the Aux Functions mode and return to the Config Mode main menu.

### Downloading EDS files

This function is described in detail on Page 4-4.

### Downloading Operating System files

**Note:** This is not a routine procedure. An operating system is loaded in the DeviceView Configurator at the factory. Use an Operating System (OS) download only when Allen-Bradley sends an upgrade disk.

#### Set up the DeviceView Configurator:

1. Connect the DeviceView Configurator Communications port to the serial port of the personal computer. Connect the Power port to an 11-25 VDC power source. See Page 3-5.
2. Use the **PREV** or **NEXT** key to cycle through the main menu until Aux Functions is displayed, and press the  $\downarrow$  key.

Config Mode	□
Aux Functions	∧ ∨

3. Use the **PREV** or **NEXT** key to display OS Upgrade, and press the  $\downarrow$  key.

Aux Functions	□
OS Upgrade	∧ ∨

### To start the DeviceView Downloader Software in the personal computer.



1. Click on the OS icon to display the Open dialog.  
Or select the Choose Download menu, then select the Download Operating System command.

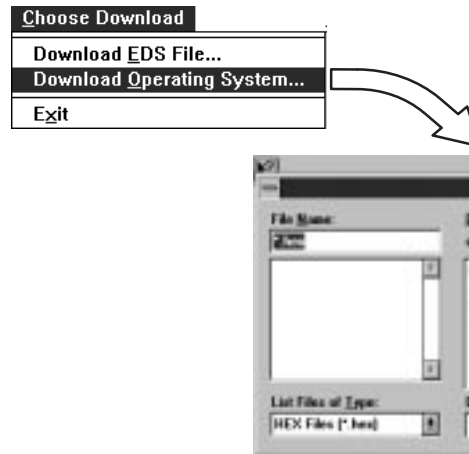

2. Click on the .HEX filename in the List Files of Type: box.  
Operating System files have a .HEX extension.  
The default directory is the Install Directory. If the new operating system is somewhere else in the system, click on the correct drive and directory to bring the .HEX file to the window.
3. Click the OK button to start the download.  
Or click the Cancel button to cancel the procedure.
4. The DeviceView Configurator waits while the file is selected and downloaded by the personal computer. The display reports one of these results:

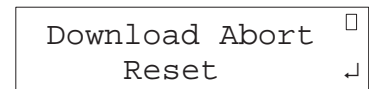
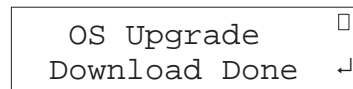

5. In either case, press the ↵ key to reset the DeviceView Configurator.

To abort the download, press the **HOME** key at any time.

## Clearing unneeded EDS files from DeviceView Configurator memory

The DeviceView Configurator can store up to 31 EDS files in its flash memory, depending on how large they are. Sooner or later the EDS Download function will not have enough room in the DeviceView Configurator to store new files.

**Note:** Files are not overwritten. If there is not enough memory when a file is downloaded from the personal computer, the download is aborted. Error messages appear on the computer screen and the DeviceView Configurator display.

Use the EDS File View/Delete command to see which EDS files are loaded and to erase selected files from DeviceView Configurator memory.

1. Use the **PREV** or **NEXT** key to cycle through the main menu until Aux Functions is displayed, and press the  $\downarrow$  key.

```
Aux Functions  □
EDS View/Delete  ^
```

2. Use the **PREV** or **NEXT** key to display EDS File View/Delete, and press the  $\downarrow$  key to display the first EDS file.
3. Use the **PREV** or **NEXT** key to view each of the EDS files loaded in the DeviceView Configurator.

```
EDS View/Delete  □
Redistation{1}  ^
```

4. Press the  $\downarrow$  key to mark each file to be deleted. A check mark appears to the right of the filename.

```
EDS View/Delete  □
Redistation{1}✓  ^
```

Press the  $\downarrow$  key again to unmark the file name and remove the check mark.

5. After all EDS files in memory have been displayed, the last item is DONE. Press the  $\downarrow$  key.

If any files were marked for deletion, they are removed at this time. Whether files are deleted or not, the display returns to the Aux Functions EDS Download option.

## Setting the Terminating Resistor

The DeviceNet network has a terminating resistor at each end of the network. The DeviceView Configurator has a terminating resistor as well, which can be enabled or disabled. When:

- the DeviceView Configurator is on a network, the resistor should be OUT
- the DeviceView Configurator is connected to one other device point-to-point, the resistor should typically be IN.



**ATTENTION:** If the resistor is enabled when the DeviceView Configurator is OnLine, it could cause network errors.

To set the resistor:

1. Use the **PREV** or **NEXT** key to cycle through the main menu until Aux Functions is displayed, and press the ↵ key.

```
Aux Functions  □
Termination    ^
```

2. Use the **PREV** or **NEXT** key to display Termination, and press the ↵ key.
3. Use the Increment or Decrement key to toggle the resistor between Out and In (Circuit), and press the ↵ key.

```
Termination    □
Resistor: Out  ▼
```

4. The display returns to the Aux Functions EDS Download screen.

The current setting is stored in flash memory and becomes the default the next time the DeviceView Configurator is powered up.

## Troubleshooting and Maintenance

This chapter covers the following topics:

- Cleaning the display window
- Hardware problems
- Operating problems

### Cleaning the Display Window

#### To clean the display window:

1. Disconnect power from the DeviceView Configurator at the power source.
2. Clean the display with a mild soap or detergent, using a clean sponge or soft cloth.
3. To prevent water spots, dry the display with a chamois or moist cellulose sponge.



**ATTENTION:** Do not scrub the window or use brushes. Abrasive cleansers or solvents may damage the window. Some types of paper towels may scratch the window.

---

#### To remove paint and grease:

1. Disconnect power from the DeviceView Configurator at the power source.
2. Remove paint splashes and grease as quickly as possible by rubbing lightly with isopropyl alcohol.
3. Clean the display with a mild soap or detergent, using a clean sponge or soft cloth.
4. To prevent water spots, dry the display with a chamois or moist cellulose sponge.

## Hardware Problems

Use a voltmeter to verify that the correct power source is connected to the terminal.



**ATTENTION:** Always disconnect power when checking wiring connections. If power is left on, there may be severe electrical shock which can injure people and damage equipment.

No internal components can be serviced by the user. If DeviceView Configurator has what appear to be hardware problems, call your Allen-Bradley distributor for assistance.

## Operating Problems

The following messages may appear if a problem occurs while DeviceView configurator is running.

### Error Messages

Message	Reason	Corrective Action
<div style="border: 1px solid black; padding: 5px; width: fit-content;">           Power-Up Test            #xx FAILED ↵         </div>	DeviceView Configurator did not pass one of the self-tests at startup. The failed self-test is identified by "xx" (see test code table below)	The Operating System may have a problem. Call the local Allen-Bradley distributor
<div style="border: 1px solid black; padding: 5px; width: fit-content;">           Critical Fault            Code xxxxx RESET         </div>	DeviceView Configurator has a major problem	Make a note of the code number and call your local Allen-Bradley distributor for help.
<div style="border: 1px solid black; padding: 5px; width: fit-content;">           DownLoad Abort <input type="checkbox"/>            Continue ↵         </div>	There is a problem in downloading an EDS or OS file	Check the connections between the computer and the configurator. Check that the correct Com port on the computer is specified.

If you encounter a problem that is not listed in the table, contact your local Allen-Bradley distributor for assistance.

### xx: Codes for Failed Power-Up Tests

Code	Meaning
10	Internal RAM test failure
11	External RAM test failure
20	Core ROM test failure
30	CAN hardware failure

---

## Specifications

### LCD Display

Character Size (H x W)	0.22 x 0.12 in (5.56 x 2.96 mm)
Character Format	5 x 7 dot matrix
Column and Character	2 lines x 16 characters
Backlight	Yellow-green LED, fixed intensity
Contrast	Fixed
Display Viewing Area (H x W)	0.58 x 2.35 in (15mm x 60 mm)
Viewing Angle	Horizontal $\pm 30^\circ$ Vertical $-20^\circ$ to $+30^\circ$

### Keypad

Keypad Type	Tactile embossed, domed keys, sealed membrane
Operation Force	16 oz. (453 grams )
Operational Life	1 million operations

### Electrical

Communications Port	RS-232
Communication Distances	50 ft. (15 meters) maximum
Input Voltage Range	11-25 VDC
Input Power, typical	1.8 Watt
Input Current	164 mA @ 11 Volts 72 mA @ 25 Volts
DeviceNet baud rates	125k, 250k, 500k

### Environmental

Operating Temperature	0 to 55°C (32 to 131° F)
Storage Temperature	-20 to 70° C (-4 to 158° F)
Relative Humidity	5 to 95%, non-condensing
Shock	30G operating 50G non-operating
Agency Rating	UL, C-UL

## Mechanical

### Dimensions (Approximate)

Height:	5.1 inch (129.5 mm)
Width:	3.55 inch (90.2 mm)
Depth:	0.975 inch (24.8 mm)

## Communications connection

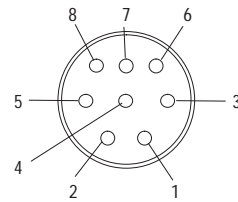
	PIN #	Signal Name
 <p>8-Pin Female C DIN Connector</p>	1	11-25 VDC from DeviceNet
	2	VDC Common
	3	Cable Shield
	4	Receive Data (RXD)
	5	CAN-L
	6	CAN-H
	7	Transmit Data (TXD)
	8	Signal Ground
	Shell	Cable Shield



## Menu Structure

### Startup, Test, and Main Menu

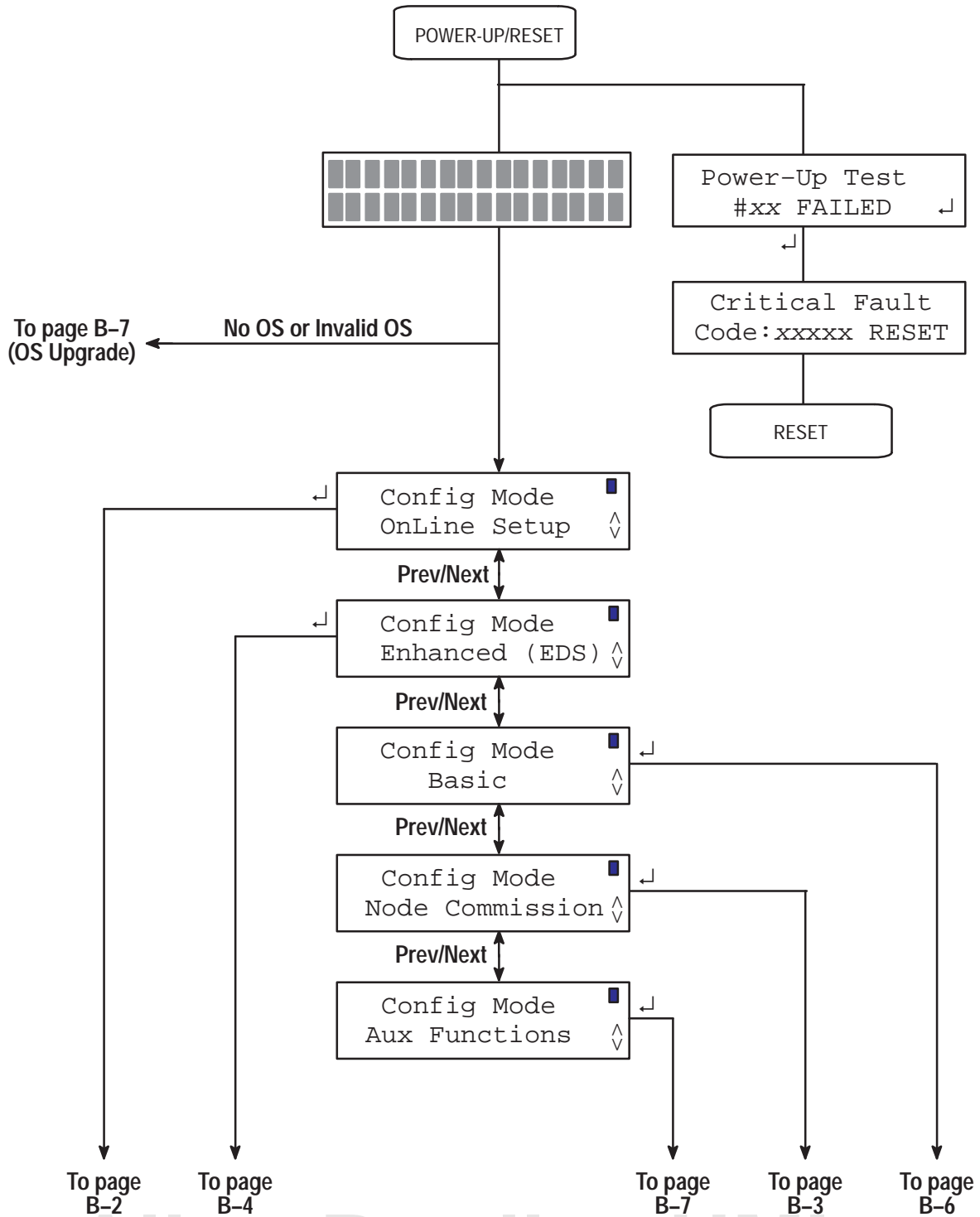

## OnLine Setup Mode

Online Setup Mode is used to set the baud rate and node address for the DeviceView Configurator itself.

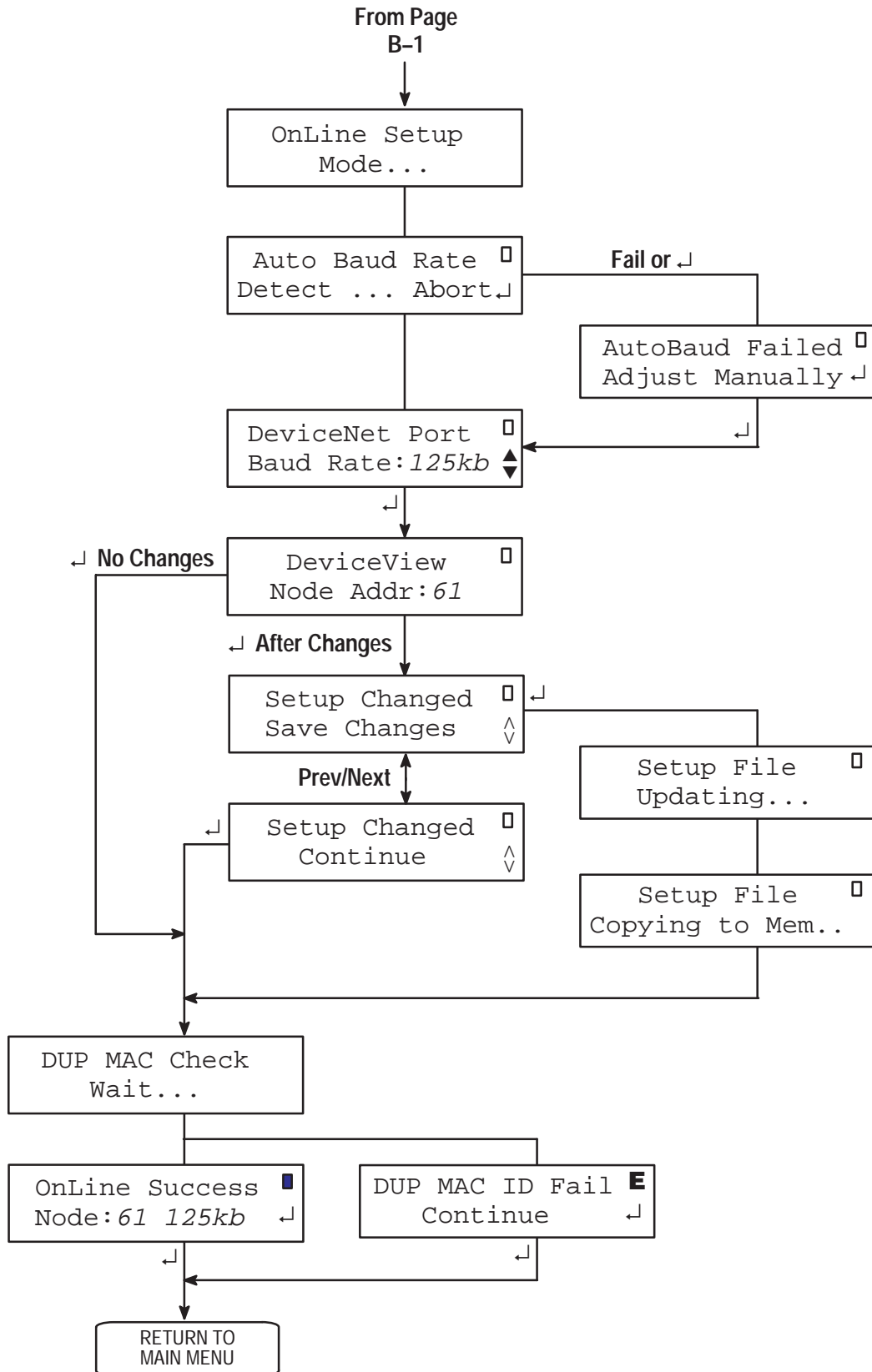

## Node Commission Mode

Node Commission Mode is used to set node address and baud rate only.

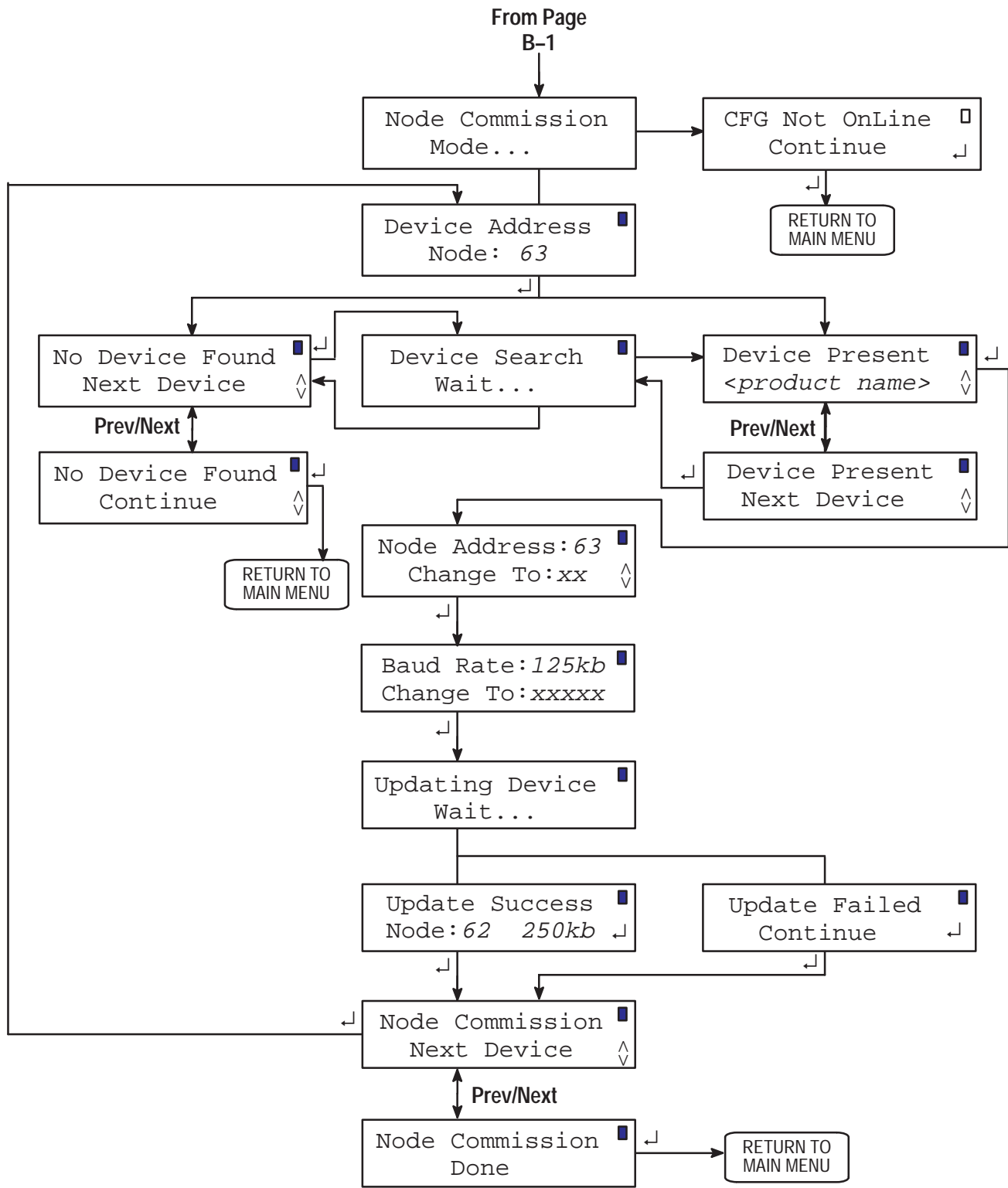

### Enhanced (EDS) Mode

Enhanced Mode is used to configure devices that have EDS files loaded in the DeviceView Configurator.

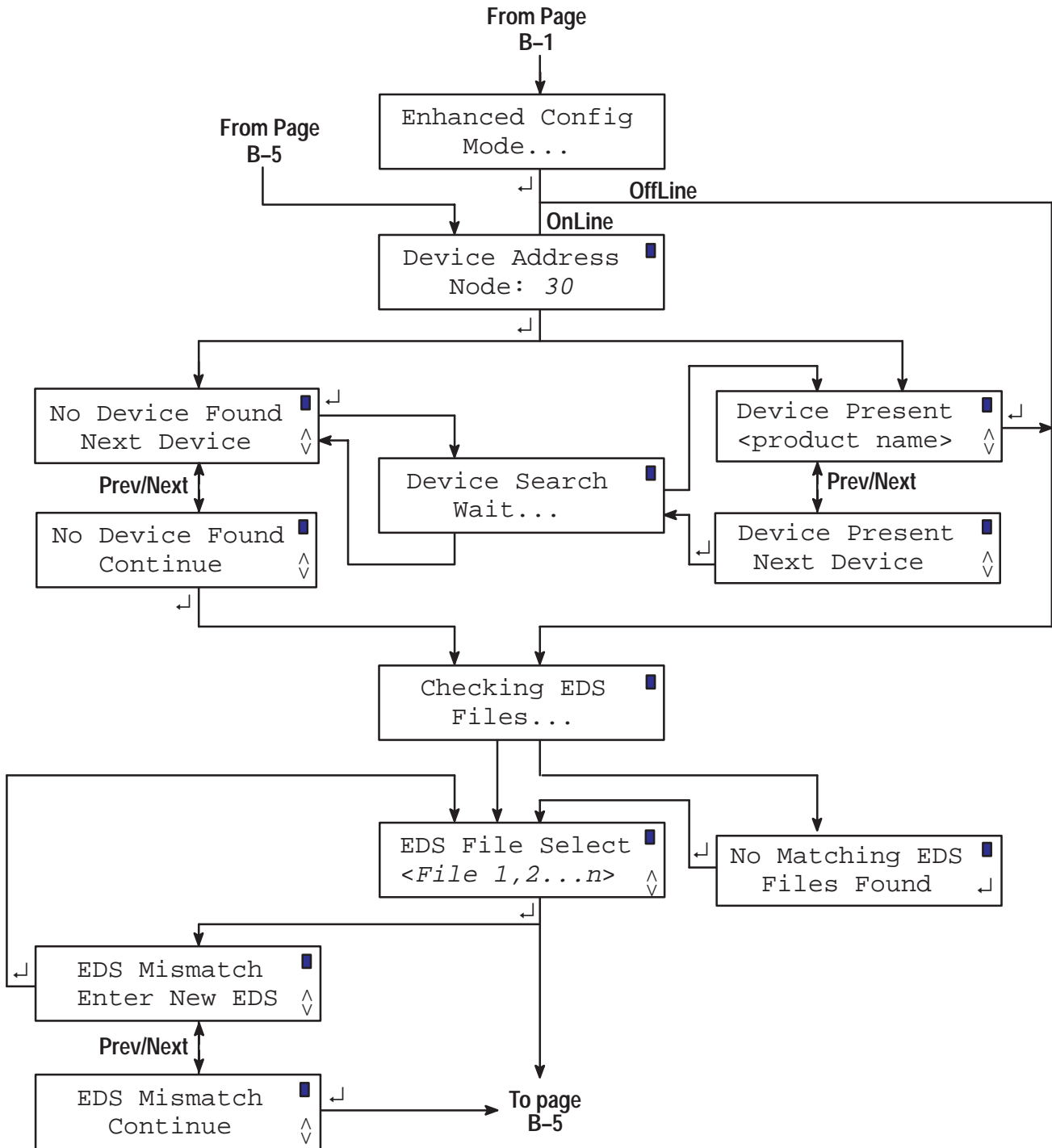

Enhanced Mode  
(Continued)

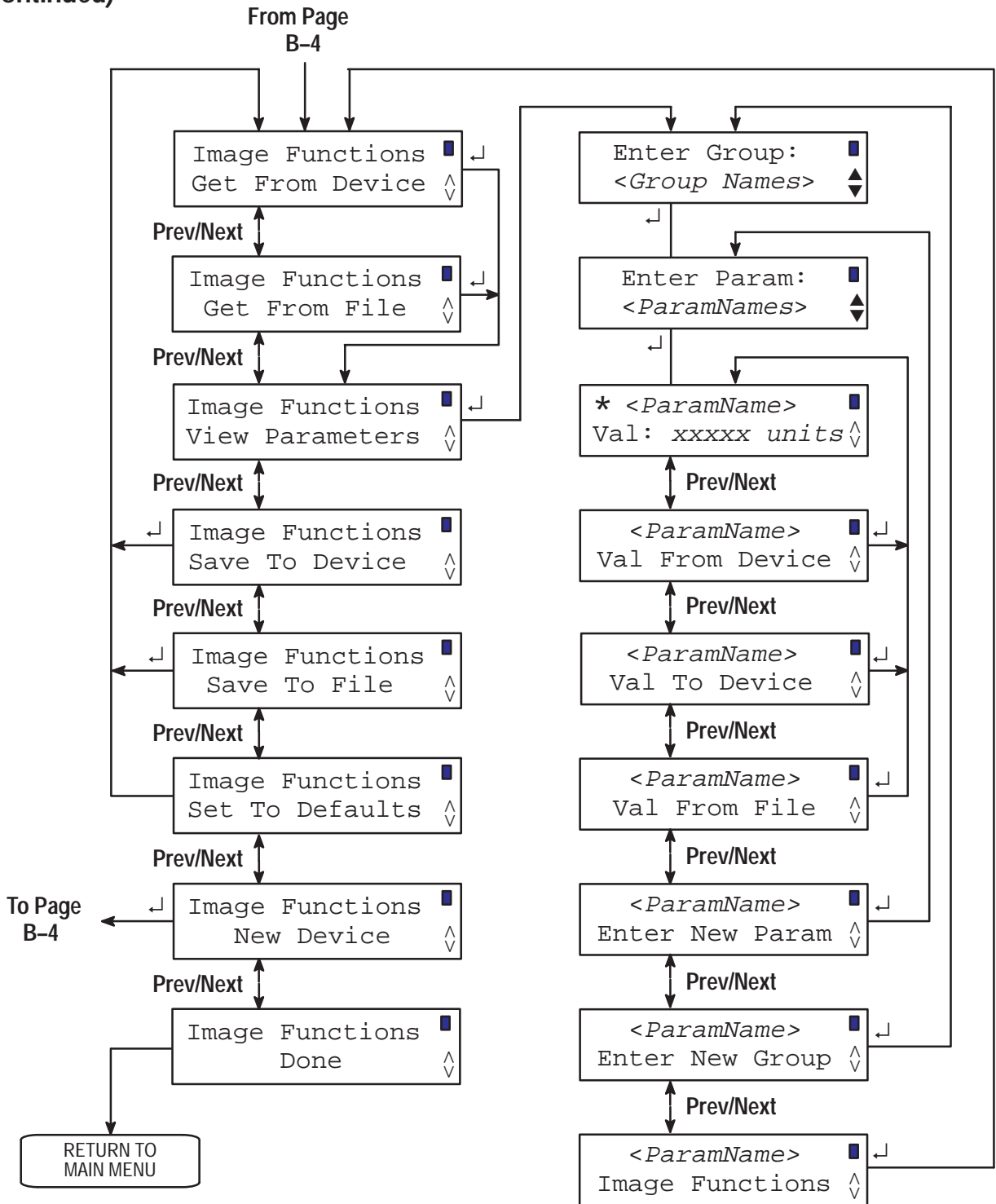

\* If a String of Bytes

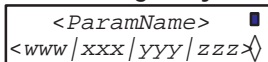

If a Bit Field Type

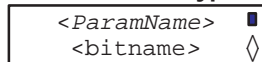

If an Enum. Type

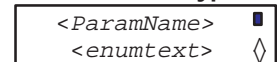

### Basic Mode

Basic Mode is used to configure devices that have no EDS files available.

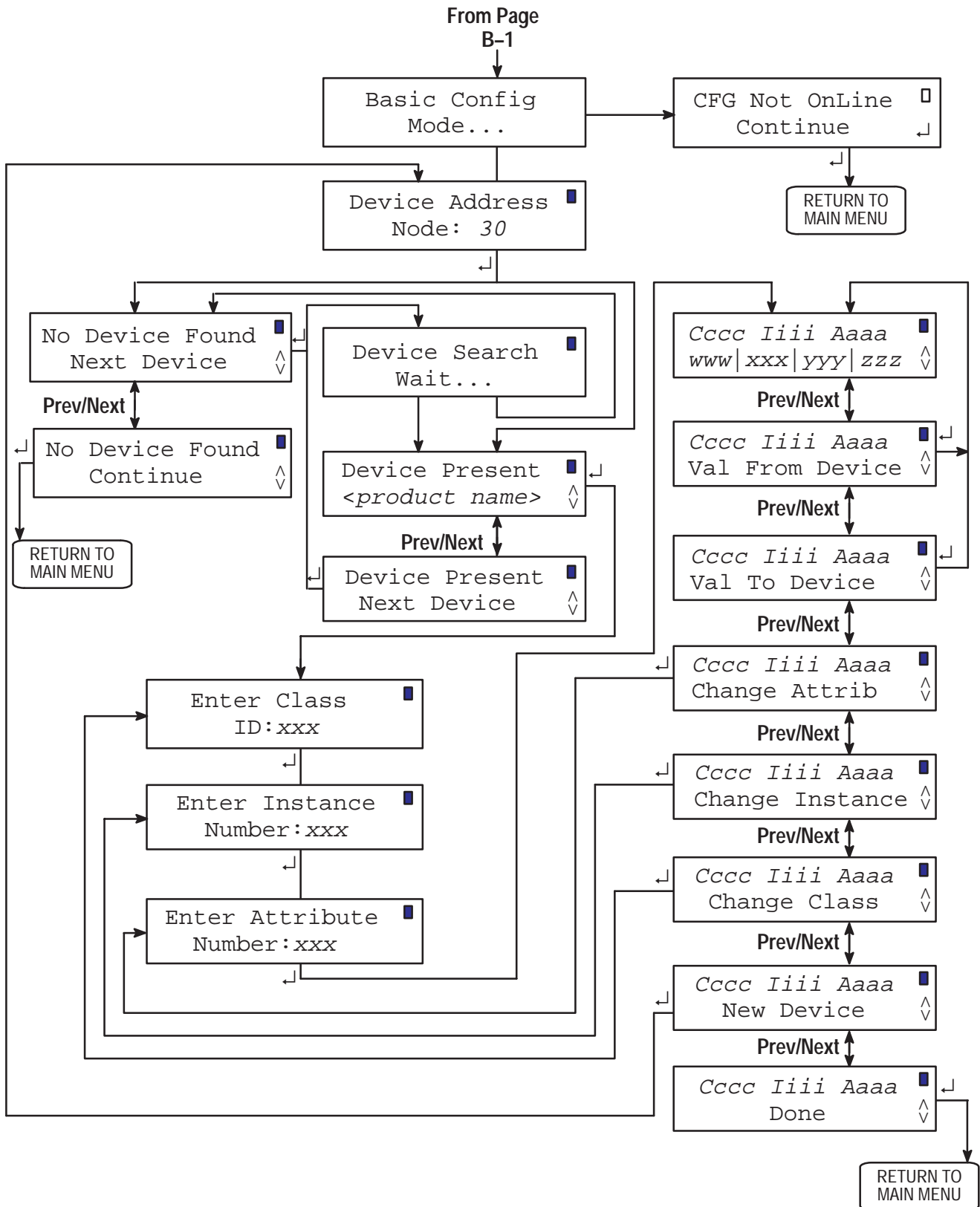

### Auxiliary Functions Mode

The Auxiliary Functions have to do with downloading EDS files or Operating System files from the personal computer and performing housekeeping tasks.

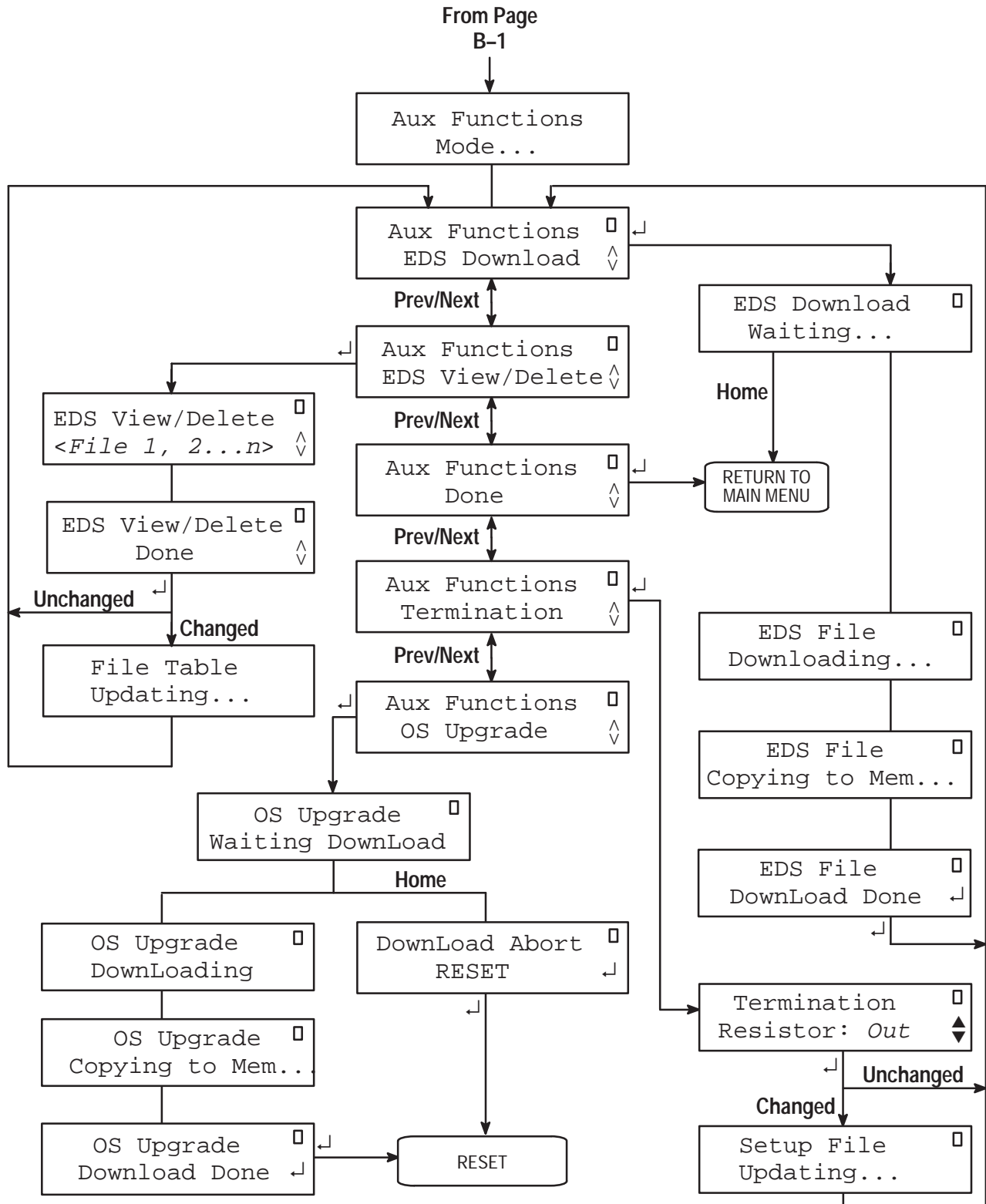

**Attribute**

In a DeviceNet network, the part of the Object Class that is edited. It may be a Class Attribute or an Instance Attribute.

**Autobaud**

In this manual, the process by which the DeviceView Configurator sets the baud rate automatically.

**CAN chip**

The Controller Area Network chip. When enabled, it allows a device to become active on a DeviceNet network.

**Configurator**

A device or system that can configure devices on a network. The configurator discussed in this manual is the DeviceNet Hand-Held Configurator.

**Device**

A hardware component that can send and receive data. In this manual, device refers specifically to a DeviceNet device that may be connected to and configured by the DeviceView Configurator.

**DeviceNet network**

A system that provides connections among devices of many kinds. High-level devices such as controllers can send and receive information from low-level devices such as sensors and actuators. The trunkline of the network contains both signal and power lines.

**DeviceView**

The product name of the DeviceNet Hand-Held Configurator. In this manual it is referred to as either DeviceView Configurator or configurator.

**Download**

To transfer information from a computer to a device.

**DUP MAC ID Check**

A check that a device's address is unique on the DeviceNet network. (MAC = Media Access Control). In this manual, a check performed by the DeviceView Configurator on its own address.



**EDS file**

An Electronic Data Sheet supplied by the device manufacturer. It contains information used to configure the device.

**Image**

In this manual, the RAM-based data associated with the current configuration session. The image is volatile, but may be stored in the device or in a file in the configurator's flash memory.

**Instance**

In a DeviceNet system, a particular occurrence of a class within a device. A device may have a number of instances of the same object class.

**Object Class**

In a DeviceNet system, a group of related data specified by a number.

**OffLine**

The state in which the DeviceView Configurator is not intended to communicate over the DeviceNet network or with an individual device.

**OnLine**

The state in which the configurator is assumed to be physically connected to a DeviceNet network or to an individual device, and is expected to communicate with a specific device.

**Operating system (OS)**

A master control program that allows an operator to control what the device does.

# Index

## A

Aux Functions Mode, 4-19- 4-22  
*See also* EDS files; terminating resistor

## B

Basic Mode, 4-13- 4-15

## C

communications  
  connection diagrams, 3-2- 3-3  
  port, 2-3  
computer, connection diagrams,  
  3-5  
Configuring devices, 2-2

## D

DeviceNet network, 2-1  
  channel, 2-4  
  connection diagrams, 3-2  
  select device Basic Mode, 4-13  
  select device, EDS Mode, 4-7  
Display, 2-2  
  conventions, 2-5  
display window, cleaning, 5-1  
Downloader software  
  installation, 3-4  
  summary, 2-8  
downloading  
  *See also* EDS files; OS files  
  summary, 2-7

## E

EDS files, 2-7  
  clearing from configurator, 4-21  
  download, 4-4- 4-6  
  editing, 4-10- 4-12  
  selecting, 4-8- 4-9  
Enhanced (EDS) Mode, 4-4- 4-10

## F

functions, summary, 2-6

## H

help, personal computer, 3-7

## K

Keypad, 2-2

## M

main menu, summary, 4-1  
memory  
  flash, 2-7  
  RAM, 2-8  
modes  
  main menu, 2-6  
  summary, 2-6

## N

Network. *See* DeviceNet network  
Node Commission Mode, 4-16-  
  4-18

**O**

OnLine Setup Mode, 2-7, 4-2-4-3  
OS files, download, 4-19

**P**

parameter image  
  saving, 2-8  
  send to device, 4-12  
power  
  connection diagrams, 3-2-3-3  
  port, 2-3  
  source, 2-4

**R**

RS-232, channel, 2-4

**S**

save, to EDS file, 2-8  
symbols, in display, 2-5

**T**

terminating resistor, 4-22  
troubleshooting, 5-2

**V**

value, send to device, 4-11



Rockwell Automation helps its customers receive a superior return on their investment by bringing together leading brands in industrial automation, creating a broad spectrum of easy-to-integrate products. These are supported by local technical resources available worldwide, a global network of system solutions providers, and the advanced technology resources of Rockwell.

## Worldwide representation.



Argentina • Australia • Austria • Bahrain • Belgium • Bolivia • Brazil • Bulgaria • Canada • Chile • China, People's Republic of • Colombia • Costa Rica • Croatia • Cyprus • Czech Republic • Denmark • Dominican Republic • Ecuador • Egypt • El Salvador • Finland • France • Germany • Ghana • Greece • Guatemala • Honduras • Hong Kong • Hungary • Iceland • India • Indonesia • Iran • Ireland • Israel • Italy • Jamaica • Japan • Jordan • Korea • Kuwait • Lebanon • Macau • Malaysia • Malta • Mexico • Morocco • The Netherlands • New Zealand • Nigeria • Norway • Oman • Pakistan • Panama • Peru • Philippines • Poland • Portugal • Puerto Rico • Qatar • Romania • Russia • Saudi Arabia • Singapore • Slovakia • Slovenia • South Africa, Republic of • Spain • Sweden • Switzerland • Taiwan • Thailand • Trinidad • Tunisia • Turkey • United Arab Emirates • United Kingdom • United States • Uruguay • Venezuela

Rockwell Automation Headquarters, 1201 South Second Street, Milwaukee, WI 53204-2496 USA, Tel: (1) 414 382-2000 Fax: (1) 414 382-4444

Rockwell Automation European Headquarters, Avenue Hermann Debroux, 46, 1160 Brussels, Belgium, Tel: (32) 2 663 06 00, Fax: (32) 2 663 06 40

Rockwell Automation Asia Pacific Headquarters, 27/F Citicorp Centre, 18 Whitfield Road, Causeway Bay, Hong Kong, Tel: (852) 2887 4788, Fax: (852) 2508 1846

World Wide Web: <http://www.ab.com>