



*Allen-Bradley*

*PanelBuilder™ 1400e  
Configuration  
Software for  
Windows®*

*(Cat. No. 2711E-ND1)*



# Reference Manual

Allen-Bradley PLCs

## Important User Information

Because of the variety of uses for the products described in this publication, those responsible for the application and use of this control equipment must satisfy themselves that all necessary steps have been taken to assure that each application and use meets all performance and safety requirements, including any applicable laws, regulations, codes and standards.

The illustrations, charts, sample programs and layout examples shown in this guide are intended solely for purposes of example. Since there are many variables and requirements associated with any particular installation, Allen-Bradley does not assume responsibility or liability (to include intellectual property liability) for actual use based upon the examples shown in this publication.

Allen-Bradley publication SGI-1.1, *Safety Guidelines for the Application, Installation, and Maintenance of Solid-State Control* (available from your local Allen-Bradley office), describes some important differences between solid-state equipment and electromechanical devices that should be taken into consideration when applying products such as those described in this publication.

Reproduction of the contents of this copyrighted publication, in whole or in part, without written permission of Allen-Bradley Company, Inc., is prohibited.

Throughout this manual we use notes to make you aware of safety considerations:



**ATTENTION:** Identifies information about practices or circumstances that can lead to personal injury or death, property damage, or economic loss.

---

Attention statements help you to:

- identify a hazard
- avoid the hazard
- recognize the consequences

**Important:** Identifies information that is critical for successful application and understanding of the product.

PanelBuilder, PanelView, Data Highway Plus, DH+, ControlNet, and SLC are trademarks, and PLC, PLC-2, and PLC-3 are registered trademarks of Allen-Bradley Company, Inc. RSView and RSLinx are trademarks of Rockwell Software, Inc. IBM, PC, PS/2, VGA, and PC-DOS are registered trademarks of International Business Machines Corporation.

Epson is a registered trademark of Seiko Epson Corporation.

Ethernet is a registered trademark of Digital Equipment Corporation, Intel, and Xerox Corporation.

Microsoft, Windows, MS, and MS-DOS are registered trademarks of Microsoft Corporation.

Mouse Systems is a trademark of MSC Technologies, Inc.

AutoCAD is a registered trademark of Autodesk Inc.

Taylor, and ProWORXPLUS are registered trademarks of Taylor Industrial Software, Inc.

MODICON, MODSOFT, Quantum, and Modbus are registered trademarks of AEG Schneider Automation, Inc.

All other brand and product names are trademarks of their respective companies and are hereby acknowledged.

# Table of Contents

---

<b>Preface</b>	Welcome to PanelBuilder 1400e Configuration Software for Windows . . . . .	P-1
	Registering Your Copy of PanelBuilder 1400e . . . . .	P-1
	Available Documentation . . . . .	P-1
	What's in the Reference Manual? . . . . .	P-2
	Who Should Read the Reference Manual? . . . . .	P-3
	Terminology Used . . . . .	P-3
	Before You Begin . . . . .	P-4
	Technical Support Services . . . . .	P-4
<b>ASCII Displays</b>	About ASCII Displays . . . . .	1
	ASCII Display String Format . . . . .	3
	Special Characters and Control Sequences . . . . .	3
	Invalid Control Sequences . . . . .	3
	Configuring the ASCII Display Object . . . . .	4
<b>ASCII Inputs</b>	About ASCII Inputs . . . . .	5
	ASCII Input Object Displays . . . . .	6
	Buttons of the ASCII Input Object . . . . .	7
	Configuring the ASCII Input Object (Large or Small) . . . . .	9
<b>Bar Graphs</b>	About Bar Graphs . . . . .	11
	Configuring the Bar Graph . . . . .	12
<b>Control Selectors</b>	About Control Selectors . . . . .	13
	Control List Selector with Enter Key . . . . .	14
	Configuring a Control List Selector with Enter Key . . . . .	15
	Control List Selector without Enter Key . . . . .	17
	Configuring a Control List Selector without Enter Key . . . . .	18
	Set Bit Cursor Points (Keypad Terminals Only) . . . . .	20
	Using the Set Bit Cursor Point on the PanelView Terminal . . . . .	21
	Cursor Point Default Operation . . . . .	22
	Cursor Point Operation after Screen Change . . . . .	23
	Cursor Point Operation on a Terminal Powerup . . . . .	23
	Defining the Set Bit Cursor Point Character and Display Field . . . . .	24
	Configuring the Set Bit Cursor Point . . . . .	25
<b>Drawings</b>	About Drawing Objects . . . . .	27
	Arc . . . . .	27
	Ellipse . . . . .	28
	Line . . . . .	28
	Arrows . . . . .	28

	Panel . . . . .	29
	Rectangle . . . . .	29
	Wedge . . . . .	29
<b>Goto Configure Mode</b>	About the Goto Configure Mode Button . . . . .	31
	Software Mode Switching at the PanelView Terminal . . . . .	33
	Configuring the Goto Configure Mode Button . . . . .	34
<b>Graphic Images</b>	About Graphic Images . . . . .	35
	Importing Graphic Images . . . . .	35
	Sizing Graphic Images . . . . .	36
	Copying and Exporting Graphic Images . . . . .	36
<b>Indicators</b>	About Indicators . . . . .	39
	Multistate Indicator . . . . .	39
	Configuring the Multistate Indicator . . . . .	40
	List Indicator . . . . .	41
	Configuring the List Indicator . . . . .	42
<b>Local Message Displays</b>	About Local Message Displays . . . . .	43
	How a Local Message Is Triggered . . . . .	44
	Triggering Messages on Multiple Local Message Displays . . . . .	44
	Configuring the Local Message Display . . . . .	44
<b>Numerics</b>	About Numerics . . . . .	47
	Increment and Decrement Value Buttons . . . . .	48
	Increment Value Button (with or without Display) . . . . .	48
	Configuring the Increment Value Button . . . . .	49
	Decrement Value Button (with or without Display) . . . . .	51
	Configuring the Decrement Value Button . . . . .	52
	Numeric Data Display . . . . .	53
	Configuring the Numeric Data Display . . . . .	55
	Numeric Keypad Enable Button (Keypad Terminals Only) . . . . .	57
	Configuring the Numeric Keypad Enable Button . . . . .	58
	Numeric Input Cursor Point (Keypad Terminals Only) . . . . .	60
	Using the Numeric Input Cursor Point on the PanelView Terminal . . . . .	60
	Defining the Numeric Input Cursor Point Character . . . . .	62
	Using the Decimal Point (Display Component) . . . . .	62
	Configuring the Numeric Input Cursor Point . . . . .	63
	Name . . . . .	63
	Numeric Input Configuration . . . . .	64
	Display Configuration . . . . .	65
	Controls . . . . .	66
	Numeric Entry Keypads (Touch Screen Terminals only) . . . . .	69
	Configuring the Numeric Entry Keypad . . . . .	70

	Examples: Editing an Array of Numeric Values . . . . .	72
	Using the Decimal Point . . . . .	75
	Enter Key Handshake Operation . . . . .	78
	Using Write Expressions . . . . .	79
<b>Push Buttons</b>		
	About Push Buttons . . . . .	81
	How the Different Push Buttons Work . . . . .	81
	Normally Open Momentary (N/O) Push Button . . . . .	82
	Configuring the Normally Open Momentary (N/O) Button . . . . .	83
	Normally Closed Momentary (N/C) Push Button . . . . .	85
	Configuring the Normally Closed Momentary (N/C) Button . . . . .	86
	Latched Push Button . . . . .	87
	Configuring the Latched Push Button . . . . .	88
	Maintained Push Button . . . . .	89
	Configuring the Maintained Push Button . . . . .	90
	Multistate Push Button . . . . .	91
	Configuring the Multistate Push Button . . . . .	92
	Interlocked Push Button . . . . .	94
	Configuring the Interlocked Push Button . . . . .	95
<b>Scales</b>		
	About Scales . . . . .	97
	Configuring the Scale . . . . .	98
<b>Screen Print Buttons</b>		
	About Screen Print Buttons . . . . .	99
	Configuring the Screen Print Button . . . . .	99
<b>Screen Selectors</b>		
	About Screen Selectors . . . . .	101
	Goto Screen and Return to Previous Screen Buttons . . . . .	102
	Configuring the Goto Screen and Return to Previous Screen Buttons . . . . .	102
	Screen List Selector . . . . .	103
	Configuring the Screen List Selector . . . . .	104
	Screen Select Keypad (Large and Small) (Touch Screen Terminals Only) . . . . .	105
	Configuring the Screen Select Keypad . . . . .	105
	Screen Keypad Enable Button (Keypad Terminals Only) . . . . .	106
	Configuring the Screen Keypad Enable Button . . . . .	106
<b>Scrolling Lists</b>		
	About Scrolling Lists . . . . .	107
	Cursor List . . . . .	108
	Configuring the Cursor List . . . . .	108
	Configuring Preview States . . . . .	110
	Configuring Retained Last List States . . . . .	111
	The Cursor List Controls . . . . .	112
	Configuring Cursor List State Values . . . . .	114

Configuring Skipped States . . . . .	115
Configuring the Cursor List Buttons . . . . .	116
Configuring the Cursor List Font . . . . .	118
Optimizing Scrolling List Performance . . . . .	118
Object Lists . . . . .	119
Multistate Indicator Object List . . . . .	121
Configuring Labels for Multistate Indicator Object Lists . . . . .	121
Configuring the Multistate Indicator Object List . . . . .	123
Local Message Object List . . . . .	124
Configuring the Local Message Object List . . . . .	124
Numeric Data Display Object List . . . . .	125
Configuring the Numeric Data Display Object List . . . . .	125
Scrolling List Example . . . . .	128
Step 1: Create the Cursor List . . . . .	129
Step 2: Create the Object Lists . . . . .	130
Assembly Stations . . . . .	130
Luxury Option . . . . .	130
Station Status . . . . .	131
Option Command . . . . .	131
Option Style Number . . . . .	132
Assigning Addresses for Object Lists . . . . .	132
Step 3: Program the PLC . . . . .	133
Create the Block Transfer Rungs . . . . .	134
Create the Auto Mode Rung . . . . .	135
Create the Manual Mode Rung . . . . .	136
Create the Toggle Command Rungs . . . . .	137
Create the Set Command Input Rung . . . . .	139
Create the Option Style Number Input Rung . . . . .	139
Create the Manual On / Manual Off Input Rung . . . . .	140
Create the Visible State File Copy Rung . . . . .	141
Create the Auto Mode Simulation Rungs . . . . .	142
<b>Symbols</b>	
About Symbols . . . . .	145
Available Graphic Images . . . . .	145
Sizing Symbols . . . . .	146
Configuring Symbols . . . . .	146
<b>Text</b>	
About Text . . . . .	149
The Extended ASCII Character Set . . . . .	149
<b>Time and Date Displays</b>	
About Time and Date Displays . . . . .	151
Time Display . . . . .	151
Date Display . . . . .	151
Configuring the Time and Date Display . . . . .	152

<b>Trends</b>	About Trends ..... 153 Configuring the Trend ..... 157 Configuring the Pens ..... 158 Configuring the Pen Value Labels ..... 159	
<b>ISA Symbols</b>	<b>Appendix A</b>	
	Symbol Icons ..... A-1	A-1
<b>DIN Symbols</b>	<b>Appendix B</b>	
	Symbol Icons ..... B-1	B-1
<b>Arrows and Parts</b>	<b>Appendix C</b>	
	Arrows ..... C-1	C-1
	Equipment Parts ..... C-2	C-2
<b>ASCII Character Set</b>	<b>Appendix D</b>	
	ASCII Character Set ..... D-1	D-1
	<b>Index</b>	

# Allen-Bradley PLCs

# Preface

## Welcome to PanelBuilder 1400e Configuration Software for Windows

Welcome to Allen-Bradley's PanelBuilder™ 1400e Configuration Software for Windows, Version 4. With this software you can create applications in the Microsoft® Windows® 3.1 (or later) operating system, Windows 95, and in Windows NT 4.0. You can use the PanelBuilder applications in PanelView™ 1000e, 1200e, or 1400e terminals, or PanelView 1200 Series F and later terminals that have been enhanced to -MC catalog numbers.

PanelBuilder 1400e Configuration Software for Windows, Version 4 provides the advantages that PanelBuilder 1400e Version 3 offered, as well as other enhancements. These include running on Windows NT 4.0, increased ControlNet station addressing, an Ethernet/RIO Pass-Through File Transfer, RSLinx communication driver compatibility, and a CD-ROM install.

For a more comprehensive description of each of these features, see “What’s New in PanelBuilder 1400e, Version 4” in Chapter 1 of *Getting Started with PanelBuilder 1400e Configuration Software for Windows*.

## Registering Your Copy of PanelBuilder 1400e

To register your software, mail the registration card from the front of this manual to this address:

Rockwell Software  
Software Services  
6680 Beta Drive  
Mayfield Village, Ohio 44143

or fax the card to 1-440-646-7701.

## Available Documentation

Your PanelBuilder 1400e software comes with several types of documentation to meet your different needs:

- *Getting Started with PanelBuilder 1400e Configuration Software for Windows* (Publication Number 2711E-818) guides you through setting up PanelBuilder 1400e and introduces you to PanelBuilder 1400e basics. It includes a tutorial to give you hands-on experience working with a PanelBuilder 1400e application.
- The *PanelBuilder 1400e Configuration Software for Windows User Manual* (Publication Number 2711E-819) explains PanelBuilder 1400e in detail, and provides step-by-step instructions for planning, creating, and working with applications.



- The *PanelBuilder 1400e Screen Objects Reference Manual* (Publication Number 2711E-820) provides detailed reference information for application screen objects.
- The *PanelBuilder 1200/1400e Transfer Utility User Manual* (Publication Number 2711E-6.8) provides detailed instructions for transferring files using the Transfer Utility that comes with PanelBuilder 1400e Version 3.
- Context-sensitive online Help provides a reference for any procedures or commands you need explained, or problems you may encounter. To get help, press F1 or choose the Help button if you're in a dialog box.
- The *PanelBuilder 1400e Readme* file is a Microsoft Windows Notepad file that is copied to your hard disk when you install PanelBuilder 1400e. It informs you of any software changes after the manuals were printed.
- The *PanelView 1000e, 1200e, and 1400e Operator Terminals User Manual* (Publication Number 2711E-821) describes the features, operation, and specifications of PanelView operator terminals.
- The *PanelBuilder 1400e Modbus User Manual* (Publication Number 2711E-6.12) describes how to create PanelBuilder applications for the Modbus communications network. This manual is supplied as part of the optional Modbus Communications Kit, Catalog Number 2711E-UMOD.

## What's in the *Reference Manual*?

The *Reference Manual* is a guide to the objects you can create for application screens. It contains the following chapters:

- ASCII Displays
- ASCII Inputs
- Bar Graphs
- Control Selectors
- Drawings
- Goto Configure Mode
- Graphic Images
- Indicators
- Local Message Displays
- Numerics
- Push Buttons
- Scales
- Screen Print Buttons
- Screen Selectors
- Scrolling Lists
- Symbols

Allen-Bradley PLCs

- Text
- Time and Date Displays
- Trends

The titles of the chapters match the selections on the Objects menu, which appears when you open a screen in PanelBuilder. If a selection on the Objects menu has a submenu, the group of related objects on the submenu is described in the same chapter. For example, numeric objects are described in the chapter called *Numerics*. The drawing objects are combined in the chapter called *Drawings*. Chapters are arranged alphabetically for easy reference.

## Who Should Read the Reference Manual?

This manual is intended as a reference guide for users who are experienced with PanelBuilder 1400e, and have a good knowledge of Microsoft Windows. Users who are not familiar with PanelBuilder 1400e should read *Getting Started with PanelBuilder 1400e Configuration Software for Windows* and the *PanelBuilder 1400e Configuration Software for Windows User Manual* first.

Users who are not familiar with Microsoft Windows should read their *Microsoft Windows User's Guide* (for users of Windows 3.1), *Introducing Microsoft Windows 95* (for users of Windows 95), or *Introducing Microsoft Windows NT Workstation* (for users of Windows NT).

## Terminology Used

The term *PanelBuilder* refers to PanelBuilder 1400e Configuration Software for Windows. Where confusion may arise between the current and previous versions of the software, the current release of software is "PanelBuilder 1400e, Version 4."

*PanelView terminal* and *terminal* refer to a PanelView 1000e terminal, an enhanced PanelView 1200 Series F or G terminal, a PanelView 1200e terminal, or a PanelView 1400e terminal.

The terms *programmable controller* and *PLC* refer to a programmable logic controller, or any other controlling device.

The term *control* is a generic term that refers to the PLC addresses that dynamic objects write to or read from. Some controls use tags only, while others can use tags or expressions. All dynamic objects use one or more controls. In this manual, the configuration table for each object lists the controls for the object, and specifies which controls use tags only and which can use expressions. For more information about expressions see Chapter 7, *Creating Expressions*, in the *PanelBuilder 1400e Configuration Software for Windows User Manual*.

*User Manual* refers to the *PanelBuilder 1400e Configuration Software for Windows User Manual*. Other user manuals are referred to by their full names.

## Before You Begin

Before you begin, you should install and know how to operate the following equipment and software:

- a personal computer with at least a 486, 25-MHz microprocessor; at least 8 MB Random Access Memory (RAM) for Windows 3.1/95 (although 16 MB RAM is recommended for Windows 95); at least 32 MB RAM for Windows NT; and a SVGA monitor with 256 colors (recommended). For users working with imported .dxf files, at least 16 MB RAM is required.

If you want to resize graphic images in PanelBuilder, set your display adapter to 65,536 colors.

- Microsoft Windows 3.1 and above, Windows 95, or Windows NT 4.0
- the family of PLCs you'll be monitoring and controlling

You should also be familiar with these manuals:

- *Getting Started with PanelBuilder 1400e Configuration Software for Windows*
- *PanelBuilder 1400e Configuration Software for Windows User Manual*

## Technical Support Services

If you have questions about PanelBuilder, please consult the manuals or the online Help first. If you can't find the answer, take advantage of our Technical Support Fax Back system, available 24 hours a day, 7 days a week at 1-440-646-5436, or browse through our technical support document library at <http://www.ab.com/mem/prodserv/services/technotes/techmain.html> on the World Wide Web.

Alternatively, contact:

Allen-Bradley  
Technical Support  
1 Allen Bradley Drive  
Mayfield Heights, Ohio 44124-6118

or call 1-440-646-6800 or fax 1-440-646-6890 for technical support between 8 AM and 5 PM (EST), Monday to Friday.

Please have the serial number for your software ready when you call, or include it on your fax. You can find this number:

- on the Software Registration card that was shipped with your software
- on the screen that appears when you start PanelBuilder
- in the main Help menu, when you choose "About"

Allen-Bradley PLCs

# ASCII Displays

This chapter tells you:

- how the ASCII Display object functions
- about special characters and control sequences
- which characters are in the ASCII character set
- about invalid control sequences
- how to configure the ASCII Display object

## About ASCII Displays



The ASCII Display object is used to display on the PanelView terminal a character string sent from the PLC. The display is updated whenever the string changes.

The ASCII Display object can display any character in the IBM extended character set. Special control characters can be included, to provide special formatting for the displayed characters. The characters displayed are controlled exactly as specified by the data in the string. Characters are processed sequentially until a null character (all bits 0) is received. Any characters after a null character are ignored.

The maximum character string length is 82 characters.

If only 10 displayable characters (not control characters) are in the string, only 10 positions on the screen will be filled. Any previously existing text anywhere else within the display area will be unaffected.

Words wrap within the area defined for the ASCII Display object, but if the character string is too long to be displayed, the extra characters are ignored.

---

### Example 1: Character String Display and Overwrite

The display is defined as 10 characters wide by 3 characters high. The characters are single height and single width. The string to be displayed is "A long string for the ASCII display."

The object will show:

```
A long
string for
the ASCII
```

The last word of the string is lost, because the object isn't large enough for the whole string.

A second string, "This shows how characters overwrite," is sent while the first one is displayed.

```
This shows
how ng for
characters
```

Any character which was not directly covered by a new character remained in the display. This feature can be useful for updating portions of an ASCII display while leaving portions unchanged. If you want to clear the display, or clear a line in the display, embed control characters for those purposes in the string.

To properly display the second string shown above, a "clear to end of display" control sequence, ESC[J, could have been included at the beginning of the string.

The string would then be: "ESC[JThis shows how characters overwrite," which would display:

```
This shows
how
characters
```

Notice that there is no space between the control sequence and the text. Also see "Special Characters and Control Sequences," and "Invalid Control Sequences," later in this chapter.

---

## ASCII Display String Format

The format of the data string must be as in the following table. For more characters see the ASCII character set in Appendix D, or see Appendix B, *The Extended Character Set*, in the *PanelBuilder 1400e Configuration Software for Windows User Manual*.

Bit	15	8	7	0
1st word	1st character		2nd character	
2nd word	3rd character		4th character	
	...		...	

## Special Characters and Control Sequences

The ASCII Display uses character 255 (■) to align display strings of odd length. Fill characters are not printable and will not occupy space on the display. For a list of the ASCII character set, see Appendix D in this manual.

The following table lists the control sequences used by the PanelView terminal.

Name	Sequence	Hex	Action
Carriage Return	CR	0D	Move to the beginning of the current line.
Line Feed	LF	0A	Move to the next line below the current one. If the current position is the last line, no more data from the string is displayed.
Clear to End of Display	ESC[0J or ESC[J	1B5B4A	Clear from the current display position to the end of the display.
Clear to End of Line	ESC[0K or ESC[K	1B5B4B	Clear from the current display position to the end of the line.
Position Text	ESC[row;columnH ESC[;columnH ESC[rowH ESC[H	1B5Bxx3Byy48 1B5B3Byy48 1B5Bxx48 1B5B48	Move the display position to the specified row and column number. The top left corner of the display area is row and column number 0,0. If either row or column number is omitted, the missing coordinate will be 0. <b>Note:</b> The coordinates are character positions. For example, position (1,1) refers to pixel coordinates (8,20) in the object.
Reverse Video Text On	ESC[7m	1B5B376D	Begin displaying text in reverse video. This flips the foreground and background colors.
Reverse Video Text Off	ESC[27m	1B5B32376D	End the reverse-video text block.

## Invalid Control Sequences

If an incorrect control sequence is detected, the invalid portion is displayed as part of the string.

For example, in the display area shown earlier, the string: “ESC[3;0HThis sequence is invalid” would be invalid: the display is 10 characters by 3 lines, and a line specification of 3 would start printing at the fourth line.

If the current display position were 0;0, the string would display:

<pre>←[3;0HThis sequence is invalid</pre>
---

The left arrow character in the display represents ESC.

Other invalid sequences:

- nested Reverse Video On, for example, “ESC[7mOneESC[7mTwo”  
The second command is invalid and, if possible, is displayed as part of the string.



**Note:** If the Reverse Video On is without an Off, the terminal automatically turns off the reverse video at the end of the string.

- nested Reverse Video Off, for example, “ESC[27mOneESC[27mTwo”  
The second command is invalid and, if possible, is displayed as part of the string.
- wrong characters in text position sequence. The text position coordinates must not contain any characters other than 0 to 9, for example, “ESC[a3;4HThe string.”

## Configuring the ASCII Display Object

Configure the ASCII Display object according to this table:

Field	Meaning
Name	Assign a name, up to 15 characters, to document the object for printed reports. This increases the application's size by 1 byte per character.
Control	ASCII Text indicates the PLC location of the string this object displays. The display is updated whenever this string changes. Assign a String type tag up to 82 characters long.

You can adjust the size of the ASCII Display and format its foreground color, background color, font style, border style, and blink and underline attributes. For details on formatting objects see “Changing Object Appearance,” in Chapter 9, *Creating Objects*, in the *PanelBuilder 1400e Configuration Software for Windows User Manual*.



**Note:** If you use the Extra Large Font, the application will be compatible only with PanelView Version 2 or later. The application will not be compatible with earlier versions.

Allen-Bradley PLCs

## ASCII Inputs

This chapter tells you:

- how the ASCII Input object functions
- how to configure the ASCII Input object

### About ASCII Inputs



The ASCII Input object allows the operator to send an alphanumeric string (up to 82 characters) to the PLC.

There are two types of ASCII Input objects:

- large ASCII Input object
- small ASCII Input object

These function differently on keypad and touch screen terminals.

- On the Large ASCII Input object for a touch screen terminal, the operator selects characters by touching the keyboard on the screen. The selected character appears in the scratchpad. When the character string in the scratchpad is complete, the operator sends it to the ASCII Input control by pressing the ENT button on the keyboard.
- On the Small ASCII Input object for both touch screen and keypad terminals, and on the Large ASCII Input object for keypad terminals, the operator selects characters from the keyboard by moving the screen cursor (with the arrow keys) to the desired character and pressing the SEL button. The selected character appears in the scratchpad. When the character string in the scratchpad is complete, the operator sends it to the ASCII Input control by pressing the ENT button.

The following table shows the scratchpad input and contents of the ASCII Input control.

Scratchpad Input	ASCII Input
leftmost character	high byte – 1st word
2nd character	low byte – 1st word
3rd character	high byte – 2nd word
4th character	low byte – 2nd word

The ASCII Input control's initial value is sent to the PLC when the application first runs. The initial value is also displayed with the object.

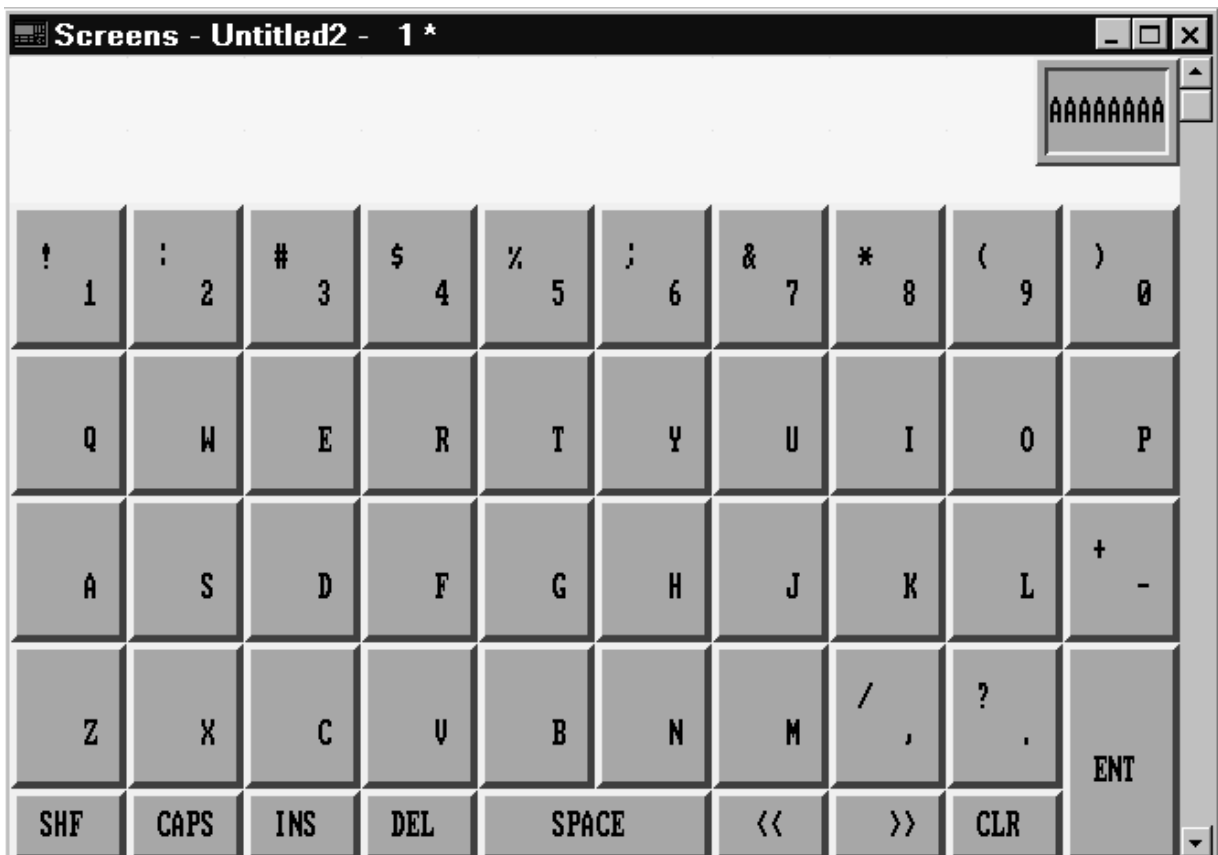


**RIO**      **Important:** In Remote I/O applications, depending on how the Application Startup screen is configured, the PanelView terminal retains the current value of the ASCII Input control even after the terminal is turned off.

**DH+**                      In DH+ applications the value is not retained.

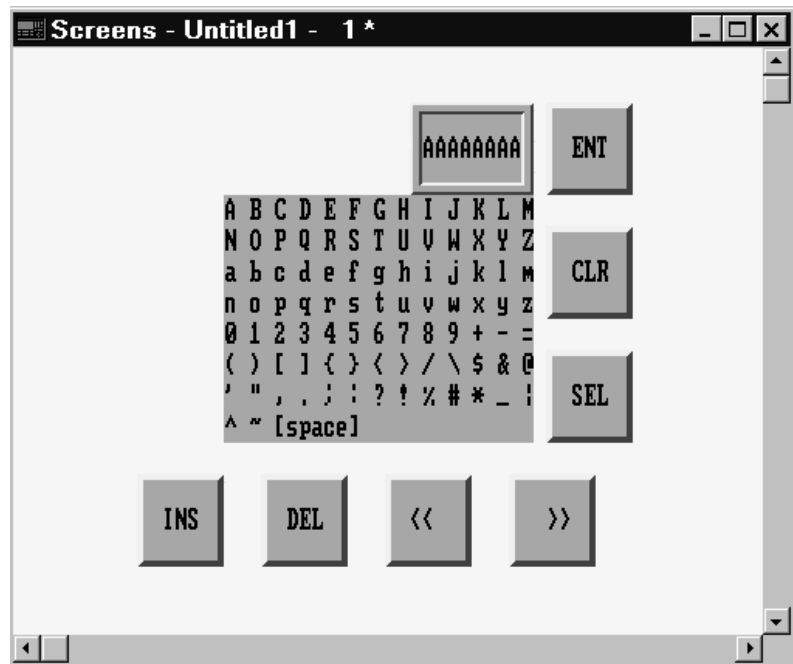
### ASCII Input Object Displays

The following illustration shows the Large ASCII Input object for a touch screen terminal.



# Allen-Bradley PLCs

The following illustration shows a Small ASCII Input Object for a keypad terminal.



### Buttons of the ASCII Input Object

The object's buttons function differently, depending on the terminal type.

The following buttons are used to edit the string displayed in the scratchpad:

- **SHF (Shift)** (Large ASCII Input object for touch screens only)—By default this button is off, and labels appear non-shifted. When this button is on, the Shift key is displayed in reverse video. All the character keys, including numbers and symbols, display and are input in their shifted state. For example, “a” becomes “A”; “2” becomes “:”.
- **CAPS** (Large ASCII Input object for touch screens only)—By default this button is off, and labels appear in lower case. When on, the button is displayed in reverse video, and the labels appear in upper case. With CAPS on, letters are input in upper case, but numbers and symbols are not shifted. The state is maintained across power cycles and screen changes.
- **INS (Insert)**—toggles the keyboard between insert and overstrike modes. The state is maintained across power cycles and screen changes.

When the keyboard entry is in insert mode the button appears in reverse video. New characters appear at the current cursor position. The cursor also moves one character to the right for each new character. The string in the scratchpad scrolls; however, if the maximum number of input characters has been entered in the scratchpad, the new character will not be inserted.

When the keyboard entry is in overstrike mode and the INS button is in normal video, new characters type over existing characters.

- **DEL (Delete)**—deletes the character at the current scratchpad cursor position.
- **<<**—moves the cursor in the scratchpad to the left.
- **>>**—moves the cursor in the scratchpad to the right.
- **CLR (Clear)**—clears the scratchpad.
- **SEL (Select)**—places the highlighted character into the scratchpad at the cursor position. (For all ASCII Input objects except the Large ASCII Input object for touch screens.)
- **ENT (Enter)**—When the operator presses the ENT button, the leftmost character is placed in the high order byte of the first PLC word, the next character to the right in the low order byte, and so on. If the character string is too large for the configured tag, the terminal displays an “out of range” error message. In this case, the character string is not sent to the PLC.

The ASCII input object supports a scrollable scratchpad area so the operator can enter a long character string in a small scratchpad. Pressing ENT sends all the characters to the PLC, not only the visible characters. For example, if the scratchpad is five characters wide, and the operator enters ten characters and presses Enter, all ten characters are sent, assuming the “Number of Input Characters” is configured to ten or more.

The string in the scratchpad is highlighted after the ENT button is pressed. If the operator selects an ASCII character immediately, the terminal clears the scratchpad and displays that character. However, if the operator presses an editing key (INS, DEL, or the cursor keys << and >> ), the terminal continues to display the existing string (no longer highlighted), allowing the operator to edit it without having to retype it.

- **Arrow keys (Large and Small ASCII Input objects for keypad terminals)**—The operator uses the arrow keys on the PanelView terminal to select characters from the keyboard.
- **Arrow keys (Small ASCII Input object for touch screen terminals)**—The operator uses the four directional arrows that are part of the object to select characters from the keyboard.

# Allen-Bradley PLCs

## Configuring the ASCII Input Object (Large or Small)

Configure the ASCII Input object according to the following table:

Field	Meaning
Name	Assign a name, up to 15 characters, to document the object for printed reports. This increases the application's size by 1 byte per character.
Type (keypad only)	Select Small ASCII Input or Large ASCII Input.
Fill Characters	Specify which character you want the ASCII string padded with if it is less than the number of input characters when the character string is sent to the PLC. Choices are: Spaces Zeroes FF* Null (default) * F is the hexadecimal equivalent of setting 4 bits to 1; FF means to set all 8 bits to 1. Each character takes up one byte (8 bits), so padding the string with FF means that all 8 bits of each unused character in the string are set to 1.
Number of Scratchpad Characters	Specify the number of characters (from 1–64) that will be visible in the scratchpad. This must be less than or equal to the number of input characters.
Number of Input Characters	Specify the number of characters (1–82) that will be sent to the PLC. If this number is greater than the number of scratchpad characters, the scratchpad will scroll to allow more characters to be entered.
Button Function Key Assignments (keypad only)	Specify a function key for each of the buttons associated with this object.
Control	The ASCII Input object uses the following controls. <b>ASCII Input</b> identifies which PLC location the string will be written to. <b>Note:</b> This must be a string tag. <b>Enter Key Control</b> and <b>Enter Key Handshake</b> must be used together to provide handshaking between the PLC and the terminal. You can assign a tag only to the Enter Key Control. You can assign a tag or expression to the Enter Key Handshake. When the operator presses the ENT button to send the value to the PLC, the terminal sets the Enter Key Control value to 1 (after the Enter Key Control delay, as specified in the Timing Parameters tab of the Terminal Setup dialog box). To inform the terminal that the handshake has been received, put a line in your PLC program to cause a 0 to non-0 transition in the Enter Key Handshake. When the terminal sees this value change from 0 to non-0, it changes the Enter Key Control value back to 0.

Field	Meaning
Control (con't)	<p>If the terminal does not receive acknowledgment (transition from 0 to non-0) within the Enter Key Handshake Time (as specified in the Timing Parameters tab of the Terminal Setup dialog box), it displays an error message in the Fault Window and resets the Enter Key Control. If the Enter Key Handshake is unassigned, the Enter Key Control remains set for the duration of the Push Button Hold Time or for as long as the button is pressed, whichever is longer.</p> <p>Because this control uses only two values, a digital tag is recommended.</p> <p><b>Important:</b> If the Enter Key Control is assigned, all keypad and touch screen input is disabled when the Enter Key is pressed, until the Enter Key Control is reset to 0.</p>

You can adjust the size of the scratchpad and format the ASCII Input object's foreground color, background color, font style, and border style. For details on formatting objects see "Changing Object Appearance," in Chapter 9, *Creating Objects*, in the *PanelBuilder 1400e Configuration Software for Windows User Manual*.



**Note:** If you use the Extra Large Font the application will be compatible with PanelView Version 2 or later. It will not be compatible with earlier versions.

# Allen-Bradley PLCs

## Bar Graphs

This chapter tells you:

- how bar graphs function
- how to configure bar graphs

### About Bar Graphs



Bar graphs are useful for monitoring analog conditions that change, such as temperature or fluid levels. You can create vertical and horizontal bar graphs across the height or width of the screen.

Vertical bars can be configured to fill from bottom to top or vice-versa. Horizontal bars can be configured to fill from left to right or vice versa.



**Tip:** Use the following suggestions to customize bar graphs:

- To show the bar's fill level, make an axis with incremental ticks alongside the bar graph by using the Scale object, or by using lines or graphic images.
- To have a bar graph change color at certain values, cascade bar graphs together. To do this, remove the border from the graphs, place the high end of one graph at the low end of the next, and adjust each graph's data range accordingly. To add a border to the cascading graphs, place a hollow or solid panel behind the bar graphs.
- To create a fully functional "template," group bar graphs with other objects. For example, position two or three bar graphs together and put numeric display objects immediately below the bar graphs to display the process variable, set point, and control variable. You can use any of the numeric entry objects interactively with these values.

## Configuring the Bar Graph

Configure the bar graph according to this table:

Field	Meaning
Name	Assign a name, up to 15 characters, to document the object for printed reports. This increases the application's size by 1 byte per character.
Graph Type	Specify Vertical Bar Graph or Horizontal Bar Graph.
Fill Direction	Specify the direction you want the bar to fill. For vertical graphs, specify either Top Down or Bottom Up. For horizontal graphs, specify either Left to Right or Right to Left.
Maximum Value	Specify the maximum value to be displayed in the graph. When the PLC value reaches (or exceeds) this value, the bar graph is completely full. Enter a value between -2,147,483,648 and 2,147,483,647. The maximum value must be greater than the minimum value.
Minimum Value	Specify the minimum value to be displayed in the graph. When the PLC value drops to (or falls below) this value, the bar graph is completely empty. Enter a value between -2,147,483,648 and 2,147,483,647. The minimum value must be less than the maximum value.
Control	Bar Graph Value identifies the value to be displayed. Assign a tag or expression to the Bar Graph Value control.

You can adjust the size of the bar graph and format its foreground color, background color, border style, and blink attributes. For details on formatting objects see “Changing Object Appearance,” in Chapter 9, *Creating Objects*, in the *PanelBuilder 1400e Configuration Software for Windows User Manual*.

## Control Selectors

This chapter discusses:

- the different types of Control Selectors
- how to use Control Selectors
- how to configure Control Selectors

### About Control Selectors

Control Selectors allow operators to select items from a list. When the application is running, the operator can move through the list using the Up and Down Cursor buttons and select items.

The choice the operator makes is always indicated by the value of the Selector Control.

There are three Control Selectors:

This Control Selector	Does this
Control List Selector with Enter Key	Allows the operator to move through a list and select a list item by pressing Enter.
Control List Selector without Enter Key	Allows the operator to move through a list. The current list item is automatically selected.
Set Bit Cursor Point (Keypad applications only)	Points to a screen character and allows the operator to select from a list or an array of objects.



**Tip:** You can position Control Selectors so they point at other objects on the same screen. For example, a Control List Selector could point to an adjacent list of Numeric Display objects. Values entered using the selector could be directed (by the PLC program) to the Displayed Value tag or expression of the numeric object being displayed.

Control List Selectors consist of a list of entries. Consider each entry in the Control List Selector as a state, where state 0 is the first entry and state 'n' is the last entry.

Each state in the list corresponds to a value. This value is written to the Selector Control.



## Control List Selector with Enter Key



The Control List Selector with Enter Key object allows the operator to choose items in a list by selecting them and then pressing Enter.

The maximum number of items in this list is determined by the size of the list component. For information on changing the size of the list component, see Chapter 9, *Creating Objects*, in the *PanelBuilder 1400e Configuration Software for Windows User Manual*.

The Control List Selector with Enter Key consists of the following components:

This component	Does this
Selector List	This vertical list can have up to 24 different states (each list item represents a state). With Double High or Large Font, the list can contain 12 states. If you use the Extra Large Font, the list can contain only 6 states.
Up Cursor Button	When the operator presses the Up Cursor button, the arrow in the list moves up by one list entry. If the Down Cursor button is enabled, you can disable the Up Cursor button. Only one of the Up and Down Cursor buttons needs to be enabled. The Up Cursor button auto-repeats at the rate specified in the Timing Parameters tab of the Terminal Setup dialog box.
Down Cursor Button	When the operator presses the Down Cursor button, the arrow in the list moves down by one list entry. If the Up Cursor button is enabled, you can disable the Down Cursor button. Only one of the Up and Down Cursor buttons needs to be enabled. The Down Cursor button auto-repeats at the rate specified in the Timing Parameters tab of the Terminal Setup dialog box.
Enter	When the operator presses Enter, the desired option is chosen and the Selector Control value is updated.

As the operator presses the Up or Down Cursor buttons, an arrow indicator moves through the list states, wrapping around the top and bottom. To make a choice, the operator presses Enter. When Enter is pressed, the list state is chosen, and the terminal updates the Selector Control with the value assigned to that state.

Because the operator can move through the list and select different states at will, the states are not necessarily executed consecutively. The new state is determined by the cursor's position in the list when Enter is pressed.

The Control List Selector with Enter Key recognizes when the Selector Control value is changed externally. For example, if the tag assigned to the Selector Control is also assigned to another object, and this object sends a new value to the tag, the Control List Selector's highlight bar moves to the list state that has this value assigned. If the state value doesn't match the tag value, the highlight bar will be removed. An error state also occurs if the Selector Control is not assigned. In this case also, no highlight bar appears.

If the Selector Control cannot accommodate a state value, an error message is displayed, and the PLC value is not changed. The operator must clear the fault before continuing.

**RIO**      **Important:** In Remote I/O applications, the PanelView terminal can retain the current value for the Control List Selector with Enter Key, even after the terminal is turned off. Depending on how the Application Startup operation is defined, the retained value (last state) or initial value (default) is sent to the PLC when power is re-applied.

For details on configuring Application Startup operation, see "Application Startup" in Chapter 5 in the *PanelView 1000e, 1200e, and 1400e Operator Terminals User Manual*.

## Configuring a Control List Selector with Enter Key

Configure the Control List Selector with Enter Key according to this table:

Field	Meaning
Name	Assign a name, up to 15 characters, to document the object for printed reports. This increases the application's size by 1 byte per character.
Control List Type	Specify Control List Selector with Enter Key.
Initial State	Specify the state that the cursor defaults to when the application is run for the first time. Choose any of the states in the list. Instead of assigning a state, you can enter a blank value in the Initial State field. This means that the object will always use the Selector Control's initial value to set the initial state.
Edit States	Change the values of the states. You can assign any unique value from -2,147,483,648 to 2,147,483,647. For more information, see "Configuring List Object States," in Chapter 9, <i>Creating Objects</i> , in the <i>PanelBuilder 1400e Configuration Software for Windows User Manual</i> . <b>Note:</b> To minimize the size of the application file, use state values that increment by one for each state. Do not configure more states than you need.

Field	Meaning
Up Cursor	Specify whether the Up Cursor button is enabled, and, if you have a keypad application, select a function key. You must have at least one of the Up and Down Cursor buttons enabled.
Down Cursor	Specify whether the Down Cursor button is enabled, and, if you have a keypad application, select a function key. You must have at least one of the Up and Down Cursor buttons enabled.
Enter	If you have a keypad application, specify which function key the operator will press to choose the highlighted selection.
Control	<p>The Control List Selector with Enter Key uses the following controls:</p> <p><b>Selector Control</b> records the state value of the list item currently selected. You can assign a tag only to the Selector Control.</p> <p><b>Note:</b> If you do not assign this control, an error state occurs when the object is displayed on the PanelView terminal. No highlight bar appears on the list, alerting the operator to the error state.</p> <p><b>Enter Key Control</b> records that the Enter Key has been pressed. You can only assign a tag to this control. When Enter is pressed after the Enter Key Control Delay time has elapsed, the control is set to 1 for the Enter Key Handshake Time (specified in the Timing Parameters tab of the Configure Terminal Setup dialog box) or until the Enter Key Handshake makes a 0 to non-0 transition. When either occurs, the Enter Key Control is reset to 0.</p> <p>Since this control uses only two values, a digital tag is recommended.</p> <p><b>Enter Key Handshake</b> is set by the PLC to confirm that it has recorded the change for the Enter Key Control. You can assign a tag or expression to the Enter Key Handshake control. The PanelView terminal sets the Enter Key Control to 1 when the operator presses the button. PLC logic must set the Enter Key Handshake to non-0 when the Enter Key Control is set. When the terminal detects a 0 to non-0 transition in the Enter Key Handshake, it resets the Enter Key Control to 0. PLC logic must then reset the Enter Key Handshake to 0.</p> <p>If this control is left unassigned, the Enter Key Control is reset after the Push Button Hold Time.</p>

You can adjust the size of each component of the Control List Selector with Enter Key and format the object's foreground color, background color, font style, button margins (touch screen applications only), border style, fill style, and blink attributes. For details on formatting objects see "Changing Object Appearance," in Chapter 9, *Creating Objects*, in the *PanelBuilder 1400e Configuration Software for Windows User Manual*.



**Note:** If you use the Extra Large Font, the application will be compatible only with PanelView Version 2 or later. The application will not be compatible with earlier versions.

Allen-Bradley PLCs

## Control List Selector without Enter Key



Unlike the Control List Selector with Enter Key, the selections in the Control List Selector without Enter Key list are highlighted and sent to the PLC as the operator moves the cursor to each item.

The number of items in this list is determined by the size of the list component. For information on changing the size of the list component, see Chapter 9, *Creating Objects*, in the *PanelBuilder 1400e Configuration Software for Windows User Manual*.

The Control List Selector without Enter Key consists of these components:

This component	Does this
Selector List	This vertical list can have up to 24 different states (each list item represents a state). With Double High or Large Font, the list can contain 12 states. If you use the Extra Large Font, the list can contain only 6 states.
Up Cursor Button	When the operator presses the Up Cursor button, the arrow in the list moves up by one list entry. If the Down Cursor button is enabled, you can disable the Up Cursor button. Only one of the Up and Down Cursor buttons needs to be enabled. The Up Cursor button auto-repeats at the rate specified in the Timing Parameters tab of the Terminal Setup dialog box.
Down Cursor Button	When the operator presses the Down Cursor button, the arrow in the list moves down by one list entry. If the Up Cursor button is enabled, you can disable the Down Cursor button. Only one of the Up and Down Cursor buttons needs to be enabled. The Down Cursor button auto-repeats at the rate specified in the Timing Parameters tab of the Terminal Setup dialog box.

► **Tip:** Build a simple two-position Control List Selector and include only the Down Cursor button. Functionally, the result is the same as a Maintained Push Button or a hard-wired, two-position selector switch. However, you also have a two-position list with the current selection highlighted.

► **Note:** The Control List Selector without Enter Key recognizes when the Selector Control value is changed externally. For example, if the tag assigned to the Selector Control is also assigned to another object, and this object writes a new value in the tag, the Control List Selector indicates the new value. If the Selector Control value does not match any of the list's state values, the highlight bar is removed.

If the Selector Control cannot accommodate the state value, an error message is displayed, and the PLC value is not changed. The operator must clear the fault before continuing.

**RIO Important:** In Remote I/O applications, the PanelView terminal can retain the current value for the Control List Selector without Enter Key, even after the terminal is turned off. Depending on how the Application Startup operation is defined, the retained value (last state) or initial value (default) is sent to the PLC when power is re-applied.

For details on configuring Application Startup operation, see “Application Startup” in Chapter 5 in the *PanelView 1000e, 1200e, and 1400e Operator Terminals User Manual*.



**ATTENTION:** A control function should require operator confirmation. Do not use this object on its own to initiate a control function. Also, a retained value could be used when the terminal is powered back on, which could result in a control function starting without the operator’s knowledge.

### Configuring a Control List Selector without Enter Key

Configure the Control List Selector without Enter Key according to this table:

Field	Meaning
Name	Assign a name, up to 15 characters, to document the object for printed reports. This increases the application's size by 1 byte per character.
Control List Type	Specify Control List Selector without Enter Key.
Initial State	Specify the state that the cursor defaults to when the application is run for the first time. Choose any of the states in the list. Instead of assigning a state, you can enter a blank value in the Initial State field. This means that the object will always use the Selector Control's initial value to set the initial state.
Edit States	Change the values of the states. You can assign any unique value from –2,147,483,648 to 2,147,483,647. For more information, see “Configuring List Object States” in Chapter 9, <i>Creating Objects</i> , in the <i>PanelBuilder 1400e Configuration Software for Windows User Manual</i> . <b>Note:</b> To minimize the size of the application file, use state values that increment by one for each state. Do not configure more states than you need.
Auto-Repeat Rate	Set the number of times per second the Up and Down Cursor buttons will repeat when pressed and held down by the operator. A value of 0 disables auto-repeat.
Auto-Repeat Start Delay	Set the time that should pass before the Up and Down Cursor buttons go into Auto-Repeat mode when pressed and held down by the operator. The range is 200 milliseconds to 2.5 seconds.

Allen-Bradley PLCs

Field	Meaning
Up Cursor	Specify whether the Up Cursor button is enabled, and if you have a keypad application, select a function key. You must have at least one of the Up and Down Cursor buttons enabled.
Down Cursor	Specify whether the Down Cursor button is enabled, and if you have a keypad application, select a function key. You must have at least one of the Up and Down Cursor buttons enabled.
Control	<p><b>Selector Control</b> records the state value of the list item currently selected. You can assign a tag only to the Selector Control.</p> <p>When the application is run for the first time, if initial values are defined, the value of the initial state is written to the Selector Control. Each time the button is pressed, the value of the next state is sent to the Selector Control. After the value for the last state is sent, the next button press wraps back to the first state. The button recognizes external control value changes. If the Selector Control value changes to one that does not match any of the state values, the next button press will set the button to state 0.</p> <p><b>Note:</b> If you do not assign this control, an error state occurs when the object is displayed on the PanelView terminal. No highlight bar appears on the list, alerting the operator to the error state.</p>

You can adjust the size of each component of the Control List Selector without Enter Key, and format the object's foreground color, background color, font style, button margins (touch screen applications only), border style, fill style, and blink attributes. For details on formatting objects see "Changing Object Appearance," in Chapter 9, *Creating Objects*, in the *PanelBuilder 1400e Configuration Software for Windows User Manual*.



**Note:** If you use the Extra Large Font, the application will be compatible only with PanelView Version 2 or later. The application will not be compatible with earlier versions.

## Set Bit Cursor Points (Keypad Terminals Only)



A group of Set Bit Cursor Point objects allows the operator to select from a list or an array of objects.

The Set Bit Cursor Point object consists of a cursor character, a display field, and a unique control.

To use the Set Bit Cursor Points at runtime, the operator must press the Select button on the PanelView terminal, thereby enabling the arrow and Home keys. The arrow keys move the cursor to the desired Set Bit Cursor Point on the terminal display. The Home key moves the cursor to the home position (the cursor position at the top left of the screen).

When the operator selects a Set Bit Cursor Point, the PanelView terminal sets the selected Set Bit Cursor Point's control to 1 and displays the Set Bit Cursor Point character highlighted and blinking. To turn off the Set Bit Cursor Point feature and disable the keys, the operator must press the Cancel button on the PanelView terminal.

Only the selected Set Bit Cursor Point will have a control value set to 1. All other Set Bit Cursor Points will have a Control value of 0.

**Important:** The Cursor Point operation status (Select or Cancel) and the current cursor point position for each application screen are maintained even after the terminal is turned off and back on. This is true for DH+, ControlNet, and Remote I/O applications.



**ATTENTION:** A control function should require operator confirmation. Do not use this object on its own to initiate a control function. Also, a retained value could be used when the terminal is powered back on, which could result in a control function starting without the operator's knowledge.

When you create a screen in PanelBuilder 1400e, all Set Bit Cursor Point characters are visible. However, when you display the screen on a PanelView terminal, only one Set Bit Cursor Point character is visible and blinking.

Place successive Set Bit Cursor Points above, below, or beside existing Set Bit Cursor Points (any distance apart). Refer to the X and Y coordinates in the status bar to make sure the Set Bit Cursor Points line up. At runtime, if the Set Bit Cursor Points aren't properly lined up, the operator may not be able to navigate from point to point as expected. There is no warning if the Set Bit Cursor Points don't line up.

# Allen-Bradley PLCs

### Example 1: Using Set Bit Cursor Points

To monitor all the motors on a conveyor belt, draw a line to represent the belt, and place Set Bit Cursor Points pointing to each motor along the belt.

Program the PLC so that when you display this screen on a terminal you can move the cursor to the desired motor and see its status in a Local Message Display or Multistate Indicator.



### Using the Set Bit Cursor Point on the PanelView Terminal

When the application is running, the operator can use these keys on the PanelView terminal to control the Set Bit Cursor Point:

This key	Does this
Select	Enables the arrow keys and Home key.
Arrow keys	Move the cursor through the Set Bit Cursor Points on the screen.
Home	Moves the cursor to the home position (at the top left of the screen).
Cancel	Turns the Set Bit Cursor Point feature off and disables the arrow and Home keys.



When selected, the Cursor Point character is highlighted and blinking. The Control is set to 1. To turn off the Set Bit Cursor Point feature and disable the keys, the operator must press the Cancel button on the PanelView terminal.

The Set Bit Cursor Point values are not changed when the Set Bit Cursor Point feature is cancelled. The last selected Set Bit Cursor Point remains on.

► **Note:** By default, when the Cancel button is pressed, the Set Bit Cursor Point character becomes invisible. To keep the character visible, even after the Cancel button is pressed, enable the Retain Cursor On Cancel check box in the Object Setup tab of the Terminal Setup dialog box. For more information about terminal setup options, see Chapter 12, “Configuring Terminal Setup Options,” in the *PanelBuilder 1400e Configuration Software for Windows User Manual*.

► **Note:** If you enable the Retain Cursor On Cancel option, the application will be compatible only with PanelView Version 2 or later. The application will not be compatible with earlier versions.

### Cursor Point Default Operation

1. When the application is run for the first time, the PanelView terminal scans all Set Bit Cursor Point objects in the screen from left to right, top to bottom. The first Set Bit Cursor Point object with its control value set to 1 is as the active Cursor Point for that screen.
2. If none are found, the Cursor Point object (Set Bit or Numeric Input) nearest the home position of the screen is the active Cursor Point object for that screen. If this is a Set Bit Cursor Point, its control is set to 1.
3. All other Set Bit Cursor Point objects in the selected screen have their control values reset to 0. Any other Numeric Input Cursor Point objects on the screen remain inactive.
4. In a Remote I/O application, when the screen is selected and the Screen Number to PLC option is enabled, both the new screen number and the new Set Bit Cursor Point values are transferred to the PLC in the same PLC scan.

► **Note:** When the application is first run, the Cursor Point operation is enabled.

# Allen-Bradley PLCs

### Cursor Point Operation after Screen Change

1. When a screen is re-selected, the Set Bit Cursor Point object that was last active is active again.
2. The object's control value is set to 1.
3. All other Set Bit Cursor Point objects in the screen have their control values reset to 0.

### Cursor Point Operation on a Terminal Powerup

The Set Bit Cursor Point operation status (Selected or Cancelled) is always saved. On powerup, as well as when you switch to a new screen, the Set Bit Cursor Point object that was active when the screen was last displayed is active.

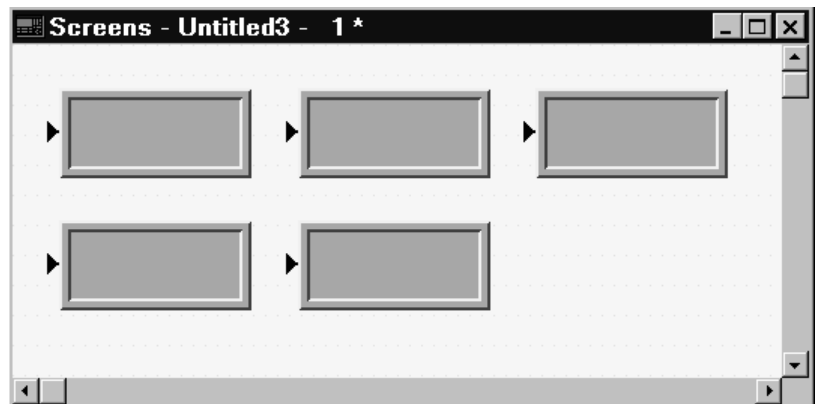


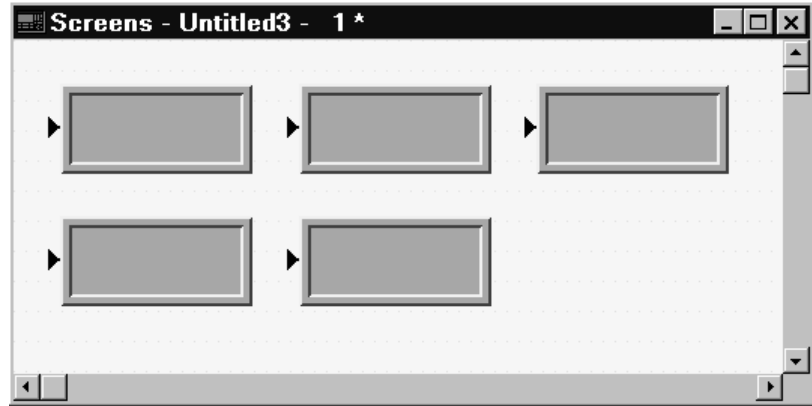
**ATTENTION:** The Set Bit Cursor Point object should not share tags with objects used for control purposes. Sharing tags could cause control functions to start without the operator's knowledge.

The following example shows how the PanelView terminal determines which Set Bit Cursor Point is active.

#### Example 2: When a Screen Uses Multiple Set Bit Cursor Points

The Application Startup screen has five Set Bit Cursor Points: three in a row at the top of the screen and two in a row below. The first two Set Bit Cursor Points in each row are aligned in columns.






When the application is downloaded, the Set Bit Cursor Point at the top left corner of the screen is selected as the default and its control is set to 1. If the right arrow key is pressed, its control is set to 0 and the second Set Bit Cursor Point in the same row is set to 1.

### Defining the Set Bit Cursor Point Character and Display Field

The Set Bit Cursor Point object consists of a cursor point character and a display field. By default the Set Bit Cursor Point object uses a small arrow as the cursor character.

► **Note:** You can change the attributes of the cursor as you would any other text character. For example, you could increase the size of the arrow by selecting another font from the Format menu. See Chapter 9, *Creating Objects*, in the *PanelBuilder 1400e Configuration Software for Windows User Manual*.

**To define the Set Bit Cursor Point character:**

1. Create the Set Bit Cursor Point object.
2. Choose Text from the Objects menu, or  from the toolbar.
3. Position the I-beam to the immediate left of the arrow on the Set Bit Cursor Point. Use the DELETE key to delete the arrow.

# Allen-Bradley PLCs

4. To use a character from the keyboard, type that character. You can type only one character. To use a character from the extended character set, hold down the ALT key while you enter the character's ASCII code on the numeric keypad. See Appendix B, *The Extended Character Set*, in the *PanelBuilder 1400e Configuration Software for Windows User Manual* for more information.

You can use text or a graphic image as the Set Bit Cursor Point display.

#### To define the Set Bit Cursor Point display field:

1. Create the Set Bit Cursor Point object.
2. Type the text you want to see associated with the cursor point, or import and place a graphic image in the display.

You can position the display on another area of the screen, instead of next to the character.

If you don't want a display with the cursor point, remove the border and change the field's background color to the screen color. This will make the field disappear.

### Configuring the Set Bit Cursor Point

Configure the Set Bit Cursor Point according to this table:

Field	Meaning
Name	Assign a name, up to 15 characters, to document the object for printed reports. This increases the application's size by 1 byte per character.
Set Bit Control	<b>Set Bit Control</b> records the status of the Set Bit Cursor Point. You can only assign a tag to this control. When it is selected, the control is set to 1. Otherwise it is 0. Since this control uses only two values, a digital tag is recommended.

You can adjust the size of the Set Bit Cursor Point's display and format the object's foreground color, background color, font style, border style, fill style, and blink attributes. For details on formatting objects see "Changing Object Appearance," in Chapter 9, *Creating Objects*, in the *PanelBuilder 1400e Configuration Software for Windows User Manual*.



**Note:** If you use the Extra Large Font, the application will be compatible only with PanelView Version 2 or later. The application will not be compatible with earlier versions.

## Drawings

This chapter tells you how to use the PanelBuilder drawing objects to illustrate your application.

- ▶ **Tip:** To simplify screen editing and maximize runtime performance, convert all text and drawing objects into wallpaper. See Chapter 9, *Creating Objects*, in the *PanelBuilder 1400e Configuration Software for Windows User Manual*, for detailed information.

### About Drawing Objects

Use the following drawing objects to illustrate your application screens:

- arcs
- ellipses
- lines
- panels
- rectangles
- wedges

- ▶ **Note:** For information about Scales, see the *Scales* chapter, later in this manual.

### Arc



You can draw arcs from one to four quadrants. You can size the arc, configure it to appear hollow or solid, and change the line style or width.

When you first draw an arc, it appears as an ellipse. Select one of the handles and drag the pointer around the circumference of the ellipse to reduce the curve to three, two, or one quadrant of the ellipse.

- ▶ **Tip:** To draw quadrants of a perfect circle, hold the Shift key as you first draw the arc.

For more details on drawing and configuring arcs, see Chapter 9, *Creating Objects*, in the *PanelBuilder 1400e Configuration Software for Windows User Manual*.

## Ellipse



You can create any size and shape of ellipse.

You can configure the ellipse as hollow or solid, and change the line style or width.



**Tip:** To create or edit a perfect circle, hold the Shift key as you draw or edit the ellipse. You can draw any size of circle.

For details on drawing and configuring ellipses, see Chapter 9, *Creating Objects*, in the *PanelBuilder 1400e Configuration Software for Windows User Manual*.

## Line



Lines can be used for emphasis, to divide the screen, to connect symbols, or to represent physical devices like pipes or conveyors. You can draw lines in any direction.



**Tip:** To create exact 45° angles when drawing or moving a line, hold the Shift key while you move the mouse.

Five line styles are available:

- Solid, in four widths (1, 2, 4, and 8 pixels)
- Dash
- Dot
- Dash-Dot
- Dash-Dot-Dot

For more information on lines and line styles, refer to Chapter 9, *Creating Objects*, in the *PanelBuilder 1400e Configuration Software for Windows User Manual*.

## Arrows

You can use the arrow graphic images to place arrows on lines. The arrow images are contained in the IMAGES directory. If you followed the default installation, the directory will be C:\AB\PB1400E\IMAGES\ARROWS.

You must import the arrow images into the graphic images library before you can place them on the screen. For instructions on importing Graphic Images, refer to Chapter 9, *Creating Objects*, in the *PanelBuilder 1400e Configuration Software for Windows User Manual*.

## Panel



Panels are similar to rectangles, except panels can have a border. They are useful for providing emphasis.

You can configure the border style of the panel and assign a hollow or solid fill pattern.

- ▶ **Tip:** To draw or edit a perfect square, hold the Shift key as you draw or edit the panel. You can draw any size of panel.

For details on drawing and configuring panels, see Chapter 9, *Creating Objects*, in the *PanelBuilder 1400e Configuration Software for Windows User Manual*.

## Rectangle



Use rectangles to emphasize text or any other object. You can draw any size of rectangle. You can configure the rectangle as hollow or solid and change its line style or width.

- ▶ **Tip:** To draw or edit a perfect square, hold the Shift key as you draw or edit the rectangle. You can draw any size of square.

For details on drawing and configuring rectangles, see Chapter 9, *Creating Objects*, in the *PanelBuilder 1400e Configuration Software for Windows User Manual*.

## Wedge



Wedges or pie-shapes are partial ellipses or closed arcs. You can draw wedges from one to four quadrants. Wedges always have a fill style and can have any line style or width.

When you first draw a wedge, it appears as an ellipse. Select one of the handles and drag the pointer around the circumference of the ellipse to reduce the curve to three, two, or one quadrant of the ellipse.

- ▶ **Tip:** To draw quadrants of a perfect circle, hold the Shift key as you draw the wedge.

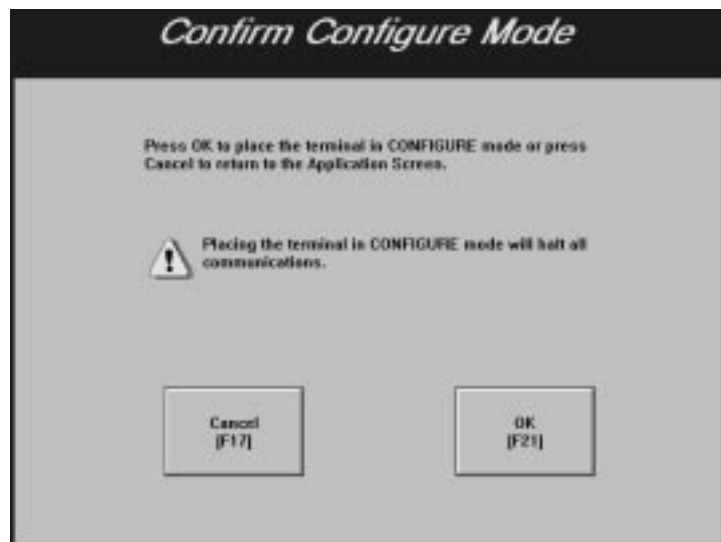
For more details on drawing and configuring wedges, see Chapter 9, *Creating Objects*, in the *PanelBuilder 1400e Configuration Software for Windows User Manual*.

### **Goto Configure Mode**

This chapter shows you how to create the Goto Configure Mode object. This object allows operators to switch the PanelView terminal from Run Mode to Configure Mode without using the terminal's hardware keyswitch (where applicable). In addition, this chapter provides tips on how to configure the Goto Configure Mode object to avoid accidental switching of the terminal to Configure Mode.

#### **About the Goto Configure Mode Button**

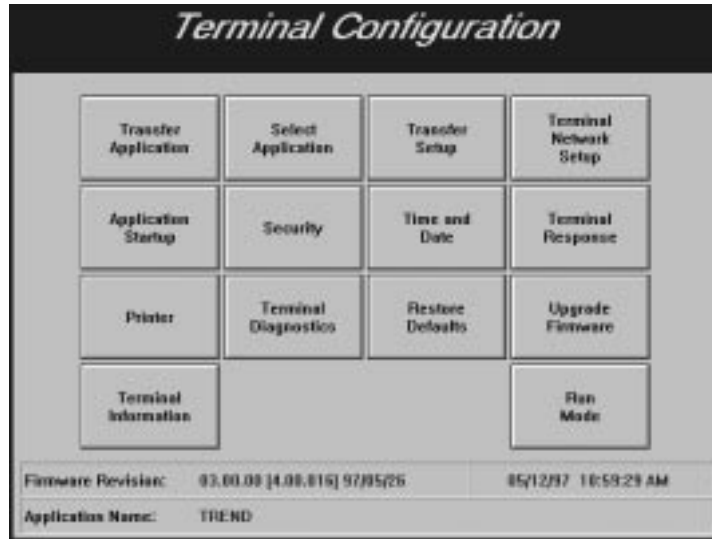
When the operator presses the Goto Configure Mode button, the terminal displays the Confirm Configure Mode screen.



After the operator presses OK the terminal switches from Run Mode to Configure Mode and displays the Terminal Configuration Screen. Pressing Cancel returns the operator to the application currently executing on the terminal without interrupting communications or execution of the application in any way.



The screen shown below is for a 1000e or 1400e touch screen terminal; the screen for the 1200e touch screen terminal includes an Align Screen function. The screen includes function key labels for 1000e, 1200e, and 1400e keypad terminals.



**Note:** The Goto Configure Mode button switches the terminal from Run Mode to Configure Mode only if Software Mode Switching is enabled on the PanelView terminal's Configure Mode Security screen. For more information about Software Mode Switching and about how the Goto Configure Mode button's twin, Run Mode, functions at the terminal, see the *PanelView 1000e, 1200e, and 1400e Operator Terminals User Manual*.

**Important:** When the terminal is switched to Configure Mode, the application that was previously running on the terminal is terminated and all communication with the PLC stops. You may therefore want to put the Goto Configure Mode button on a screen to which security has been assigned, so an operator does not inadvertently switch the terminal out of Run Mode.

**Important:** If Software Mode Switching is enabled on the PanelView terminal's Configure Mode Security screen, a Goto Configure Mode button will be present on all Major Fault windows and on the Application Transfer screen. The Goto Configure Mode button cannot be protected by screen security in these instances and any operator can switch the terminal to Configure Mode.

# Allen-Bradley PLCs

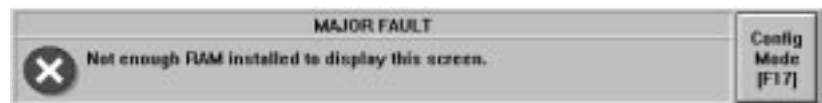
## Software Mode Switching at the PanelView Terminal

For the Goto Configure Mode Button to operate, the Soft Mode Switch must be enabled, and the terminal's hardware keyswitch must be in Run mode. The Goto Configure Mode button allows operators to switch between Run and Configure modes without using the hardware keyswitch.

When in Configure Mode, press the Mode Switch tab in the Security window to display the following screen.



**Important:** If the Software Mode Switch is set to Enable, the Goto Configure Mode button is displayed without access restrictions on both the Transfer Application screen and the Major Fault window. (See below for a screen display.) This may pose a security issue, because **all** operators will be able to switch between Run and Configure modes.



The presence of the Goto Configure Mode button in an application running on the PanelView terminal does not disable the terminal's hardware keyswitch; the terminal can still be switched from Run mode to Configure mode using the keyswitch or remote keyswitch (if fitted).

The following table shows the behavior of the terminal at power up:

If the terminal is powered up with	Then the terminal powers up in
The Software Mode Switching option disabled	The mode indicated by the hardware keyswitch
The Software Mode Switching option enabled, and the hardware key switch in Run Mode	The same mode it was in at power down
The Software Mode Switch option enabled and the hardware keyswitch in Configure Mode	Configure Mode

The Software Mode Switch button also lets you enable or disable the Run Mode button on the Terminal Configuration screen.

- **Enable**—If you enable the software mode switch, operators can switch the terminal from Run mode to Configure mode using the Goto Configure Mode button. Also the Run Mode button on the Terminal Configuration screen is enabled.
- **Disable**—If you disable the software mode switch, the Goto Configure Mode button is disabled, and the Run Mode button on the Terminal Configuration screen is disabled.

### Configuring the Goto Configure Mode Button

Configure the Goto Configure Mode button according to this table:

Field	Meaning
Name	Assign a name, up to 15 characters, to document the object for printed reports. This increases the application's size by 1 byte per character.
Function Key (Keypad only)	Specify which function key the operator must press to activate this button.

You can adjust the size of the button and format its foreground color, background color, button margins (touch screen applications only), border style, fill style, and blink attributes. For details on formatting objects see “Changing Object Appearance,” in Chapter 9, *Creating Objects*, in the *PanelBuilder 1400e Configuration Software for Windows User Manual*.

# Allen-Bradley PLCs

## Graphic Images

This chapter tells you how to use graphic images.

For step-by-step instructions about importing, placing, sizing, copying, and exporting graphic images, refer to Chapter 9, *Creating Objects*, in the *PanelBuilder 1400e Configuration Software for Windows User Manual*.

► **Tip:** To simplify screen editing and maximize runtime performance, convert all graphic images except object labels into wallpaper. See Chapter 9, *Creating Objects*, in the *PanelBuilder 1400e Configuration Software for Windows User Manual*, for detailed information.

### About Graphic Images



Use graphic images to illustrate screens, objects, functions, and so on. You can add graphic images to the screen background, or add them to an object as object labels. See *Symbols* later in this manual for information about using graphic images as object labels.

If you followed the default installation, you'll find a set of bitmap (.bmp) files in the folders contained in the C:\AB\PB1400E\IMAGES directory. The images in these folders include all ISA symbols, arrow images, DIN symbols, and other color bitmaps. See Appendix A, *ISA Symbols*, Appendix B, *DIN Symbols*, and Appendix C, *Arrows and Parts*, for samples of these graphic images.

### Importing Graphic Images

You can import bitmaps from any other application into PanelBuilder 1400e's bitmap graphic image library. You can also import 2-D AutoCAD graphics saved in the .dxf file format into PanelBuilder 1400e's DXF Image library. Transparent AutoCAD .dxf images are made solid when converted for use in PanelBuilder. Color bitmaps and .dxf graphics are converted into 16-color images; monochrome bitmap images are imported as monochrome. The maximum graphic image size is 640 by 480 pixels. If you import a file larger than this, PanelBuilder automatically shrinks it to 640 by 480 pixels.

► **Note:** AutoCAD (.dxf) graphics are converted to bitmap files when PanelBuilder creates the application's .pvd file for downloading to the PanelView terminal.

- ▶ **Tip:** Convert two-color bitmaps to monochrome before you import them. Monochrome images use less memory and therefore provide better runtime performance. You can configure a monochrome image's foreground and background colors, fill style, and blink attributes. You can't change the format of 16-color images.
- ▶ **Tip:** Because PanelBuilder converts color images to 16-color bitmaps, a 256-color image may not convert as expected. To achieve a photographic appearance for your color bitmaps, import images that use few colors. Screen 10 of the demonstration applications shows a good example: TANK16.BMP uses grays and greens and has the quality of a photographic image. If you followed the default installation, the demonstration application files are in the PB1400E\DEMO folder.

Once bitmaps and .dxf files are imported into the application's graphic image libraries, you can select the files and place them on the application screen or in objects as labels.

### Sizing Graphic Images

You can increase or decrease the size of the graphic images once you place them on screens in PanelBuilder. You can use multiple copies of the same graphic image and change the size of any or all of them. The size of the source image remains unchanged; PanelBuilder saves each new size of the image as a separate graphic when the application's .pvd file is created.

- ▶ **Note:** The application's size increases each time you resize an image. Limit the number of images you resize to ensure that your application will fit in the terminal's memory.

### Copying and Exporting Graphic Images

If you copy a graphic image to another PanelBuilder application, its size attributes are copied as well. If you export a graphic image, it is exported with its original size dimensions, or with the size 640 by 480 pixels, if it was originally larger than this. When exporting, if the source image was a .dxf file, the exported file is a bitmap (.bmp) representation of the source image.



**Note:** If you are concerned about minimizing the size of your application, use as few graphic images as possible. For each graphic image you use, the application file's size increases the number of bytes in the image. Copies of a graphic image take much less space than the original, so you might consider using the same image on several screens rather than placing a unique image on each screen. Ensure that all copies are the same size as the original, however, otherwise each copy is saved as a separate image. Monochrome graphic images take less file space than 16-color images that are the same height and width.

## Indicators

This chapter tells you about:

- the different types of Indicators
- how to configure each Indicator

### About Indicators

You can create these two types of Indicators:

- Multistate Indicator
- List Indicator

Indicators do not retain their values when the terminal is turned off.

### Multistate Indicator



The Multistate Indicator is a display object that enables the operator to display the state of a PLC operation on the screen.

You can use the Multistate Indicator for various purposes. For example, create a Multistate Indicator that is only two pixels high to simulate flow in a pipe or indicate the motion of an object. Use a two-state solid rectangle to simulate an indicator light, add descriptive text to the object, or add a graphic image. Or, use a Multistate Indicator to hide text until it is needed or becomes applicable.

You can configure the state values of Multistate Indicator objects. At runtime, the object displays the state whose value matches the Indicator State control value.

► **Note:** If the Indicator State control contains a value that doesn't match any of the Multistate Indicator's assigned state values, an error state occurs and the highest numbered state is displayed without its label. An error state also occurs if the Indicator State control is not assigned. In this case also, the highest numbered state is displayed without its label.

► **Tip:** If you plan to use the same graphic image for each state, use a Symbol instead of a Multistate Indicator. You can configure the Symbol to display different colors or blink attributes for different states, and the Symbol uses less memory. PanelView also processes the information more quickly for Symbols than for Multistate Indicators. For more information, see *Symbols*, later in this manual.

## Configuring the Multistate Indicator

For each Multistate Indicator, you must specify the number of states (from 2 to 255), and define an Indicator State control. At runtime, the value at the Indicator State control determines the state that is displayed on the PanelView terminal.

Configure the Multistate Indicator according to this table:

Field	Meaning
Name	Assign a name, up to 15 characters, to document the object for printed reports. This increases the application's size by 1 byte per character.
Number of States	Specify the number of states, from 2 to 255, this object will display.
Edit States	<p>If you increase the number of states beyond the default of 4, you must assign state values. You can also change the default state values for the default 4 states.</p> <p>To assign different values to the states, choose Edit States. You can assign any unique value from -2,147,483,648 to 2,147,483,647. See "Configuring Object States," in Chapter 9, <i>Creating Objects</i>, in the <i>PanelBuilder 1400e Configuration Software for Windows User Manual</i> for information on assigning state values and configuring state attributes.</p> <p><b>Note:</b> To minimize the size of the application file, use state values that increment by one for each state. Do not configure more states than you need.</p> <p>You should configure colors, text, graphic images, and other attributes for each state.</p>
Control	<p><b>Indicator State</b> controls the state for this object. You can assign a tag or expression to this control.</p> <p>When the PLC changes the control's value, the terminal displays the state with the assigned value.</p> <p><b>Note:</b> If you do not assign this control, an error state occurs when the object is displayed on the PanelView terminal. The highest numbered state is displayed without its label, alerting the operator to the error state.</p>

You can adjust the size of the Multistate Indicator and format its background color, border style, and blink attributes. For details on formatting objects see "Changing Object Appearance," in Chapter 9, *Creating Objects*, in the *PanelBuilder 1400e Configuration Software for Windows User Manual*.



## List Indicator



The List Indicator displays a list of states for a particular PLC operation and highlights the current state.

The font size determines the maximum number of states possible in the list. Small and Double Wide fonts allow up to 24 states; Double High or Large fonts allow up to 12 states. If you use the Extra Large font the maximum number of states is 6.

- ▶ **Note:** List text can be in only one font size. The List Indicator supports text labels only, not graphic image labels.

At runtime, the operator can see all the states for a particular operation and see which state is current. The current state is highlighted. The size of the list component determines the number of states. For information on changing the font size, resizing the list, and adding state text, see “Changing Object Appearance,” in Chapter 9, *Creating Objects*, in the *PanelBuilder 1400e Configuration Software for Windows User Manual*.

The List Indicator is similar to the Control List Selector, except the PLC, rather than the operator, controls the display.

You can configure the state values of List Indicator objects. At runtime, the object highlights the state whose value matches the Indicator State control’s value.

- ▶ **Note:** If the Indicator State control contains a value that doesn’t match any of the List Indicator’s assigned state values, an error state occurs and no state is highlighted. An error state also occurs if the Indicator State control is not assigned. In this case also, no highlight bar appears.

## Configuring the List Indicator

The size of the List Indicator, font size, and border configuration determine the maximum number of states. To increase or decrease the number of states, resize the list. Configure the List Indicator according to this table:

Field	Meaning
Name	Assign a name, up to 15 characters, to document the object for printed reports. This increases the application's size by 1 byte per character.
Edit States	Assign different values to the states. You can assign any unique value from -2,147,483,648 to 2,147,483,647. See "Configuring List Object States" in Chapter 9, <i>Creating Objects</i> , in the <i>PanelBuilder 1400e Configuration Software for Windows User Manual</i> for information on assigning state values.  <b>Note:</b> To minimize the size of the application file, use state values that increment by one for each state. Do not configure more states than you need.
Control	<b>Indicator State</b> controls the state for this object. You can assign a tag or expression to the Indicator State control.  When the PLC changes the control's value, the terminal highlights the state with the assigned value.  <b>Note:</b> If you do not assign this control, an error state occurs when the object is displayed on the PanelView terminal. No highlight bar appears on the list, alerting the operator to the error state.

You can adjust the size of the List Indicator and format its foreground color, background color, font style, border style, and blink attributes. For details on formatting objects see "Changing Object Appearance," in Chapter 9, *Creating Objects*, in the *PanelBuilder 1400e Configuration Software for Windows User Manual*.



**Note:** If you use the Extra Large Font, the application will be compatible only with PanelView Version 2 or later. The application will not be compatible with earlier versions.

# Local Message Displays

This chapter explains:

- how the Local Message Display object functions
- how to configure the Local Message Display object

## About Local Message Displays



The Local Message Display provides information to the operator by displaying one message from a list.

There are two components to a local message: the Local Message Display object, and the list of local messages. You add Local Message Display objects to screens; you define the messages in the Local Messages editor. You can create up to 2000 messages per application. The message's text can contain any characters, including those in the extended ASCII character set. For information about creating messages, see Chapter 10, *Creating Messages*, in the *PanelBuilder 1400e Configuration Software for Windows User Manual*.

Each Local Message Display object is assigned a Message Control. The value of this control determines which message is displayed. For example, if the control value is 39, the local message that has trigger value 39 is displayed. You can program the PLC to set this value, or you can add objects to the screen so the operator can control which local message is displayed.

The Local Message Display object can display single or multiple lines of message text, depending on the object size and font size. A local message can contain up to 256 characters. You can select any font size, including the Extra Large font.

At runtime, if the display is wide enough to display the full message on one line, the text appears centered within the display area. If the message is longer than the display area, it is left-justified.

If the display is not wide enough, automatic word wrapping occurs so the message is displayed on multiple lines, and the text is left-justified. If the message uses the newline character (\n), the text after the character begins on a new line of the display. If the message is longer than the display, the message is truncated to fit. The ">" character at the end of the message indicates it has been truncated.

## How a Local Message Is Triggered

A message is triggered when the value of the Message Control changes. This value must correspond to the trigger value of a local message. For example, a control value of 19 would cause the message with trigger value 19 from the Local Message list to appear in the display. If the control value changed to 27, the message with trigger value 27 would appear, replacing the previous message. The Local Message Display is cleared when the trigger value is 0. If no matching trigger value is found, the display is cleared and displays “???”.

## Triggering Messages on Multiple Local Message Displays

Each application has only one local message list but you can have several Local Message Displays for different purposes. To trigger different messages for different displays, create a subset of the local message list for each display.

To trigger different messages on multiple Local Message Displays, create the display objects using controls with different tags or expressions that don't overlap addresses. Then create all messages using the Local Message editor.

The PLC can then write different values to each object control, causing different messages to appear in each display.

For an example of using Local Message Displays with a Scrolling List Object, see “Scrolling Lists”, later in this manual.

## Configuring the Local Message Display

Configure the Local Message Display according to this table:

Field	Meaning
Name	Assign a name, up to 15 characters, to document the object for printed reports. This increases the application's size by 1 byte per character.
Control	<b>Message Control</b> records the trigger value of the local message to be displayed. You can assign a tag or expression to the Message Control.  The control must be able to accommodate the trigger values of all messages to be displayed for the object.

---

You can adjust the size of the Local Message Display and format its foreground color, background color, font style, border style, and blink and underline attributes. For details on formatting objects see “Changing Object Appearance,” in Chapter 9, *Creating Objects*, in the *PanelBuilder 1400e Configuration Software for Windows User Manual*.



**Note:** If you use the Extra Large Font, the application will be compatible only with PanelView Version 2 or later. The application will not be compatible with earlier versions.

## Numerics

This chapter describes:

- the different Numeric objects
- how to configure each Numeric object
- how different Numeric objects can work together

### About Numerics

There are six Numeric objects:

- Increment Value Button (with and without Display)
- Decrement Value Button (with and without Display)
- Numeric Data Display
- Numeric Keypad Enable Button (keypad terminals only)
- Numeric Input Cursor Point (keypad terminals only)
- Small or Large Numeric Entry Keypad (touch screen terminals only)

Numeric objects can be divided into two groups: input objects (which are used for numeric entry) and display objects (which display numeric values on the screen). Some numeric objects belong to both groups.

The following table outlines which objects are input and which are display. It also outlines which objects support polarity, decimal points, and floating decimal points.

Object	Input	Display	Polarity	Decimal Point	Floating Decimal
Increment Value Button	✓				✓
Increment Value Button with Display	✓	✓			✓
Decrement Value Button	✓				✓
Decrement Value Button with Display	✓	✓			✓
Numeric Data Display		✓	✓	✓	✓
Numeric Keypad Enable Button	✓			✓	✓
Numeric Input Cursor Point	✓	✓	✓	✓	✓
Numeric Entry Keypad	✓			✓	✓

The following table lists tag types, data types, and the valid range of values available when assigning tags to numeric objects.

Tag Type	Data Type	Range of Values
Analog	Default	Address dependent (for Device tags) 0 to 65535 (for RIO tags)
	Unsigned Integer	0 to 65535
	Integer	-32768 to 32767
	Long Integer	-2,146,483,648 to 2,147,483,647
	Floating Point	$-3.402823 \times 10^{38}$ to $-3.402823 \times 10^{-37}$ , 0, $+3.402823 \times 10^{-37}$ to $+3.402823 \times 10^{38}$
	Byte	0 to 255
	Binary	Address dependent
	Bit Position	Address dependent
	1-Digit BCD to 8-Digit BCD	0 to 99,999,999
	Digital	0 or 1
String	1 to 82 characters	
Block	1 to 1024 bits	

## Increment and Decrement Value Buttons



Increment and Decrement Value Buttons are input objects that the operator presses to change a current value.

### Increment Value Button (with or without Display)

When the operator presses the Increment Value Button, the value of the Button Control increases by a specified integer or floating-point amount.



**Note:** If you configure the Increment Value Button for floating-point values, the application will be compatible only with PanelView Version 2 or later. The application will not be compatible with earlier versions.

You can control the value range by assigning an upper limit to the button. If the operator tries to increment the Button Control above the upper limit, an error message is displayed, and the value is not sent to the PLC.

You can choose to have the Increment Value Button's numeric value displayed. You can place the Numeric Display component anywhere on the screen.

# Allen-Bradley PLCs

- ▶ **Tip:** If you want immediate indication of the value you're sending to the PLC, use the button's Numeric Display component instead of a Numeric Data Display. This is especially important for DH+ and ControlNet applications when Auto-Repeat is enabled. Since the DH+ and ControlNet network response can be slow, you don't want to overshoot the target value when the button is auto-repeating. The Numeric Display component shows the last value sent to the PLC. Use a separate Numeric Data Display object if you want to feed back the value you've written.
- ▶ **Note:** When the button is released, the Numeric Display component will be aware of any external changes to the Button Control and update itself.

At runtime, if the numeric value cannot be displayed—for example, if the field is too small—the Numeric Display component is filled with asterisks (\*\*\*) .

## RIO

**Important:** In Remote I/O applications, the PanelView terminal can retain the current Button Control value, even after the terminal is turned off. Depending on how the Application Startup operation is defined, the retained value (last state) or initial value (default) is sent to the PLC when power is re-applied.

For details on configuring Application Startup operation, see “Application Startup” in Chapter 5 in the *PanelView 1000e, 1200e, and 1400e Operator Terminals User Manual*.



**ATTENTION:** A control function should require operator confirmation. Do not use this object on its own to initiate a control function. Also, a retained value could be used when the terminal is powered back on, which could result in a control function starting without the operator's knowledge.

## Configuring the Increment Value Button

Configure the Increment Value Button according to this table:

Field	Meaning
Name	Assign a name, up to 15 characters, to document the object for printed reports. This increases the application's size by 1 byte per character.
Button Type	Specify Increment Value Button.
Function Key (Keypad only)	Specify which function key the operator must press to activate this button.



Field	Meaning
Auto-Repeat Rate (per second)	Specify a number between 0 and 20. When the operator holds down the Increment Value Button, the terminal begins increasing the value at the Button Control by the "Amount per Increment" value at the rate you specify in this field.  A value of 0 disables auto-repeat. When the button is pushed and held, the value at the Button Control increases once by the amount specified in the Amount per Increment field. The button must be released and pushed again for the next increment.
Auto-Repeat Start Delay	Specify the time, between 200 milliseconds and 2.5 seconds, that the operator must hold down the Increment Value Button before the auto-repeat function starts.
Amount per Increment	Enter an integer or floating-point value between 0.000000001 and 2,147,483,647. Floating-point values are accurate to 10 significant digits. The value at the control increases by this amount each time the operator presses the button or at each auto-repeat.
Maximum Value	Define a maximum value above which the Increment Value Button value will stop increasing. If the value is already at or above the maximum you define here, and the Increment Value Button is pressed, the value will not change. Instead, an error message appears. Enter a value between -2,147,483,648 and 2,147,483,647. Floating-point values are accurate to 10 significant digits.
Show Numeric Display	Check this field if you want the button's value to be displayed. If you choose this, it will be an Increment Value Button with Display object.
Number of Digits	If you choose to show the numeric display with the button, you can specify the number of digits that will appear. Choose from 1 to 16. Keep in mind that a minus sign uses one digit.
Fill Left With	If you choose to show the numeric display with the button, you can specify how the left portion of the display appears when fewer than the maximum number of digits are displayed. You can choose either spaces or zeroes.
Control	<b>Button Control.</b> The control's value increases by the specified amount each time the operator presses the Increment Value Button or when the button auto-repeats. You can assign only a tag to this control.

You can adjust the size of the Increment Value Button and format its foreground color, background color, button margins (touch screen applications only), border style, fill style, and blink attributes. If you choose the Show Numeric Display option you can also format the display's font style and underline attributes. For details on formatting objects see "Changing Object Appearance," in Chapter 9, *Creating Objects*, in the *PanelBuilder 1400e Configuration Software for Windows User Manual*.



**Note:** If you use the Extra Large Font, the application will be compatible only with PanelView Version 2 or later. The application will not be compatible with earlier versions.

# Allen-Bradley PLCs



## Decrement Value Button (with or without Display)

When the operator presses the Decrement Value Button, the value of the Button Control decreases by a specified integer or floating-point amount.

► **Note:** If you configure the Decrement Value Button for floating-point values, the application will be compatible only with PanelView Version 2 or later. The application will not be compatible with earlier versions.

You can control the value range by assigning a lower limit to the button. If the operator tries to decrement the Button Control below the lower limit, an error message is displayed and the value is not sent to the PLC.

You can choose to have the Decrement Value Button's numeric value displayed. You can place the Numeric Display component anywhere on the screen.

► **Tip:** If you want immediate indication of the value you're sending to the PLC, use the button's Numeric Display component instead of a Numeric Data Display. This is especially important for DH+ and ControlNet applications when Auto-Repeat is enabled. Since the DH+ and ControlNet network response can be slow, you don't want to overshoot the target value when the button is auto-repeating. The Numeric Display component will show the last value sent to the PLC. Use a separate Numeric Data Display object if you want to feed back the value you've written

► **Note:** When the button is released, the Numeric Display component will recognize any external changes to the Button Control and update itself.

At runtime, if the numeric value cannot be displayed—for example, if the field is too small—the Numeric Display component is filled with asterisks (\*\*\*)

### RIO

**Important:** In Remote I/O applications, the PanelView terminal can retain the current Button Control value, even after the terminal is turned off. Depending on how the Application Startup operation is defined, the retained value (last state) or initial value (default) is sent to the PLC when power is re-applied.

For details on configuring Application Startup operation, see “Application Startup” in Chapter 4 in the *PanelView 1200e and 1400e Operator Terminals User Manual*.



**ATTENTION:** A control function should require operator confirmation. Do not use this object on its own to initiate a control function. Also, a retained value could be used when the terminal is powered back on, which could result in a control function starting without the operator's knowledge.

## Configuring the Decrement Value Button

Configure the Decrement Value Button according to this table:

Field	Meaning
Name	Assign a name, up to 15 characters, to document the object for printed reports. This increases the application's size by 1 byte per character.
Button Type	Specify Decrement Value Button.
Function Key (Keypad only)	Specify which function key the operator must press to activate this button.
Auto-Repeat Rate (per second)	Specify a number between 0 and 20. When the operator holds down the Decrement Value Button, the terminal begins decreasing the value at the Button Control by the "Amount per Decrement" value at the rate you specify.  A value of 0 disables auto-repeat. When the button is pushed and held, the value at the Button Control is decreased once by the amount specified in the Amount per Decrement field. The button must be released and pushed again for the next decrement.
Auto-Repeat Start Delay	Specify the time, between 200 milliseconds and 2.5 seconds, that the operator must hold down the Decrement Value Button before the auto-repeat function starts.
Amount per Decrement	Enter an integer or floating-point value between 0.000000001 and 2,147,483,647. Floating-point values are accurate to 10 significant digits. The value at the control will decrease by this amount each time the operator presses the button or at each auto-repeat.
Minimum Value	Define a minimum value below which the Decrement Value Button will stop decrementing the value. If the value is already at or below the minimum you define here, and the Decrement Value Button is pressed, the value will not change. Instead, an error message appears. Enter a value between -2,147,483,648 and 2,147,483,647. Floating-point values are accurate to 10 significant digits.
Show Numeric Display	Check this field if you want the button's value to be displayed. If you choose this, it will be a Decrement Value Button with Display.
Number of Digits	If you choose to show the numeric display, you can specify the number of digits that will appear. Choose from 1 to 16. Keep in mind that a minus sign uses one digit.

Field	Meaning
Fill Left With	If you choose to show the numeric display with the button, you can specify how the left portion of the display will appear when fewer than the maximum number of digits are displayed. You can choose either spaces or zeroes.
Control	<b>Button Control</b> . The control's value increases by the specified amount each time the operator presses the Increment Value Button or when the button auto-repeats. You can assign only a tag to this control.

You can adjust the size of the Decrement Value Button and format its foreground color, background color, button margins (touch screen applications only), border style, fill style, and blink attributes. If you choose the Show Numeric Display option you can also format the display's font style and underline attributes. For details on formatting objects see "Changing Object Appearance," in Chapter 9, *Creating Objects*, in the *PanelBuilder 1400e Configuration Software for Windows User Manual*.



**Note:** If you use the Extra Large Font, the application will be compatible only with PanelView Version 2 or later. The application will not be compatible with earlier versions.

## Numeric Data Display



The Numeric Data Display object allows the operator to monitor a PLC process. This object displays PLC values such as temperature, level, and speed.

Depending on how you configure the Numeric Data Display object, it can display a decimal point and a minus sign.



**Tip:** Use Numeric Data Displays with other objects. For example, include a Numeric Keypad (for touch screen terminals), or a Numeric Keypad Enable Button (for keypad terminals) on the same screen as a Numeric Data Display. Assign the same Control to both objects so the display can show the control's current value as entered by the input object.

**Important:** The Numeric Data Display does not retain its value when power is switched off and on.

The following examples show how the Numeric Data Display works. They illustrate how the Decimal Display and polarity options affect the way numbers are displayed.

---

### Example 1: Displaying a Negative Fractional Value

The Displayed Value control has a fractional value. The value displayed depends on the assigned Decimal Display option and the value of the Polarity control.



**Note:** Implicit (floating-point) values are accurate up to 7 significant digits. If there are more than 7 significant digits, the number is rounded off.

The following table illustrates how the Decimal Display option determines the display. The Displayed Value control is set to -3124.798.

If Polarity is unassigned, and the Decimal Display option is set to	This value is displayed
Disabled	-3125
Implicit	-3124.798
PLC Controlled at 1 digit	-3124.8
Fixed Position at 5 digits	-3124.79800

The following table illustrates how the value of the Polarity control determines the display. The Displayed Value control is set to -3124.798.

If the Decimal Display is set to Implicit, and the Polarity control is this value	This value is displayed
Unassigned	-3124.798
0	3124.798
1	-3124.798

---

### Example 2: Displaying an Integer Value

The Displayed Value control has an integer value. The value displayed depends on the assigned Decimal Display option and the value of the Polarity control.

The following table illustrates how the Decimal Display option determines the display. The Displayed Value control is set to 3124.

# Allen-Bradley PLCs

If Polarity is unassigned, and the Decimal Display option is set to	This value is displayed
Disabled	3124
Implicit	3124
PLC Controlled at 1 digit	312.4
Fixed Position at 5 digits	.03124

The following table illustrates how the value of the Polarity control determines the display. The Displayed Value control's value is  $-3124$ .

If the Decimal Display is set to Implicit, and the Polarity control is this value	This value is displayed
Unassigned	$-3124$
0	3124
1	$-3124$

## Configuring the Numeric Data Display

Configure the Numeric Data Display according to the following table:

Field	Meaning
Name	Assign a name, up to 15 characters, to document the object for printed reports. This increases the application's size by 1 byte per character.
Fill Left With	Choose whether the left portion of the display will be filled with zeroes or blank spaces when fewer than the maximum number of digits are displayed.
Number of Digits	Specify the number of digits to display, up to a maximum of 16. Keep in mind that a decimal point and minus sign each take one digit.  At runtime, if the value can't be displayed within the number of digits specified for the object, a string of asterisks (*) is displayed.
Decimal Display	How you configure the decimal display and polarity determines the appearance and behavior of the Numeric Data Display. (See the examples before this table.) The configuration also determines the tags or expressions you must assign. Each Numeric Data Display can have only one configuration.  <b>Disabled</b> —Select this item if you don't want any decimal point displayed. If the Displayed Value control contains a decimal point, it will be rounded off.

Field	Meaning
Decimal Display (con't)	<p><b>Implicit</b>—The value from the Displayed Value control will be displayed as it is, without any external decimal manipulation. For example, a value of "1" is displayed as "1". A value of "1.3" is displayed as "1.3." If the number of digits following the decimal point is too large to fit in the display, the fraction is rounded off to fit the number of digits. For example, if the display has four digits, and the value is "1.237," the display will show "1.24." If an integer value or the integer portion of a number can't be displayed fully, asterisks (***) are displayed instead.</p> <p><b>PLC Controlled</b>—Select this item if you want the position of the decimal point to be determined by the PLC. This means that the decimal point is not in a fixed position, and the PLC controls the number of digits after the decimal point. If the Displayed Value control is a fractional number and has fewer than the specified number of digits to the right of the decimal point, the value will be <b>padded with zeroes</b>. If the value has more than the number of digits, the value will be rounded off. The PLC Controlled decimal position can display 1 to 15 decimal digits. If the value returned by the Decimal Point Position control is outside this range, the display field is filled with asterisks (***). If you check this button, define the Decimal Point Position control.</p> <p><b>Fixed Position</b>—Select this item if you want the decimal point to appear always in the same position. See Digits after Decimal Point, next.</p> <p><b>Tip:</b> Use Fixed Position with an analog tag that has scale and offset defined to achieve the version 5.10 Scaled Numeric Data Display capability. Or, define an expression so that it will manipulate the PLC output to achieve the same effect.</p> <p>If the Displayed Value control is a fractional number and has fewer than the specified number of digits to the right of the decimal point, the value is padded with zeroes. If the value has more than the number of digits, the value is rounded off.</p>
Digits after Decimal Point	<p>If you specify the decimal point as Fixed Position, enter the number of digits that will appear after the decimal point. The maximum is 15.</p>
Control	<p>The Numeric Data Display uses the following controls. You can assign a tag or expression to each control.</p> <p><b>Displayed Value</b> contains the value to be displayed. If the control uses a tag with a float address or a non-standard scale and offset value, the object can display a fractional value.</p> <p><b>Important:</b> If you assign the Polarity control, when you define the Displayed Value control use a digital or analog tag with any of the following unsigned data types: byte, binary, bit position, or 1 to 8 BCD. If you use a signed data type, do not assign the Polarity control unless you want to override the value's own polarity.</p> <p><b>Decimal Point Position</b> determines the position of the decimal point. Define this control if you specified the Decimal Display field as PLC Controlled. The value of this control determines the number of digits after the decimal point.</p> <p><b>Polarity</b> determines whether or not a minus sign is displayed. If the Polarity control's value is other than 0, the minus sign is always displayed; if it is 0, the sign is never displayed. If this control is assigned, it overrides the Displayed Value control's polarity. Remember to account for the minus sign in the number of digits you assign.</p>

You can adjust the size of the Numeric Data Display and format its foreground color, background color, font style, border style, and blink and underline attributes. For details on formatting objects see “Changing Object Appearance,” in Chapter 9, *Creating Objects*, in the *PanelBuilder 1400e Configuration Software for Windows User Manual*.



**Note:** If you use the Extra Large Font, the application will be compatible only with PanelView Version 2 or later. The application will not be compatible with earlier versions.

## Numeric Keypad Enable Button (Keypad Terminals Only)



The Numeric Keypad Enable Button object calls up the Numeric Keypad scratchpad. The operator enters a numeric value in the scratchpad to be sent to the PLC. If you assign the Optional Keypad Write Expression, the PanelView terminal can perform a mathematical calculation or logical operation on the value the operator enters, and then send the result to the PLC.

While the Numeric Keypad scratchpad is on the screen, the Cancel key, numeric keypad, backspace, decimal point, minus sign and Home/Arrow keys remain active. All other keys and buttons are disabled.

The Numeric Keypad scratchpad is removed when:

- the Cancel key is pressed
- the screen changes
- the operator moves the cursor to a Set Bit Cursor Point
- mode is switched

The Numeric Keypad scratchpad can display up to 16 digits. The decimal point and minus sign use one digit each.



**Note:** The Numeric Keypad scratchpad appears over the top 60 pixels of the screen. Keep this in mind before you place objects in this area.

### RIO

**Important:** In Remote I/O applications, the PanelView terminal can retain the current values for the object’s controls, even after the terminal is turned off. Depending on how the Application Startup operation is defined, the retained value (last state) or initial value (default) is sent to the PLC when power is re-applied.

For details on configuring Application Startup operation, see “Application Startup” in Chapter 4 in the *PanelView 1200e and 1400e Operator Terminals User Manual*.



## Configuring the Numeric Keypad Enable Button

Configure the Numeric Keypad Enable Button according to the following table:

Field	Meaning
Name	Assign a name, up to 15 characters, to document the object for printed reports. This increases the application's size by 1 byte per character.
Scratchpad	Specify whether you want the Numeric Keypad scratchpad to be retained or removed after the operator presses the Enter key:  <b>Retain after Enter</b> retains the scratchpad on the screen. <b>Remove after Enter</b> removes the scratchpad from the screen.
Decimal Point	Specify whether the operator can enter a number with decimal points, and how the decimal points appear in the scratchpad.  <b>Disabled</b> —the operator can't enter a decimal point. <b>Implicit</b> —allows the operator to enter the number and decimal point. Assign an analog tag with Floating Point data type. <b>Fixed Position</b> —you specify where the decimal point is positioned in the scratchpad display. See Digits after Decimal Point, next. <b>PLC Controlled</b> —allows the PLC to determine the number of digits that appear after the decimal point by specifying a value in the tag for the Decimal Point Position control. The PLC Controlled decimal position can display 1 to 15 decimal digits. If the value returned by the Decimal Point Position control is outside this range, the decimal point character is replaced by a single asterisk (*). <b>Decimal Key Controlled</b> —allows the operator to enter the number and decimal point. The terminal calculates the decimal point position and writes this value to the Decimal Point Position control. See "Using the Decimal Point" later in this chapter for more information.
Digits after Decimal Point	If you specify the decimal point as Fixed Position, enter the number of digits that will appear after the decimal point. The maximum is 15.
Function Key	Specify which function key the operator must press to call up the scratchpad.

Field	Meaning
Control	<p>The Numeric Keypad Enable Button uses the following controls:</p> <p><b>Keypad Numeric Input</b> identifies the PLC location to which the terminal writes the value that the operator enters in the scratchpad. You can assign only a tag to this control.</p> <p>Define this control for all Decimal Point options.</p> <p><b>Optional Keypad Write Exprn</b> performs a mathematical calculation or logical operation on the value the operator enters at the PanelView terminal, then sends the result to the Keypad Numeric Input control. Use of this control is optional. You can assign only an expression to this control. See “Using Write Expressions” later in this chapter for information about assigning this control.</p> <p><b>Decimal Point Position</b> determines or indicates the position of the decimal point.</p> <p>If you specified the Decimal Point field as PLC Controlled, you can assign a tag or expression to this control.</p> <p>If you specified the Decimal Point field as Decimal Key Controlled, you can assign only a tag.</p> <p><b>Enter Key Control</b> and <b>Enter Key Handshake</b> are used together to provide handshaking between the PLC and the terminal. See “Enter Key Handshake Operation” later in this chapter for more information. You can assign only a tag to the Enter Key Control. You can assign a tag or expression to the Enter Key Handshake control.</p> <p><b>Important:</b> All function keys are disabled while the terminal is waiting for handshake acknowledgement.</p>

You can adjust the size of the Numeric Keypad Enable Button and format its foreground color, background color, border style, fill style, and blink attributes. For details on formatting objects see “Changing Object Appearance,” in Chapter 9, *Creating Objects*, in the *PanelBuilder 1400e Configuration Software for Windows User Manual*.

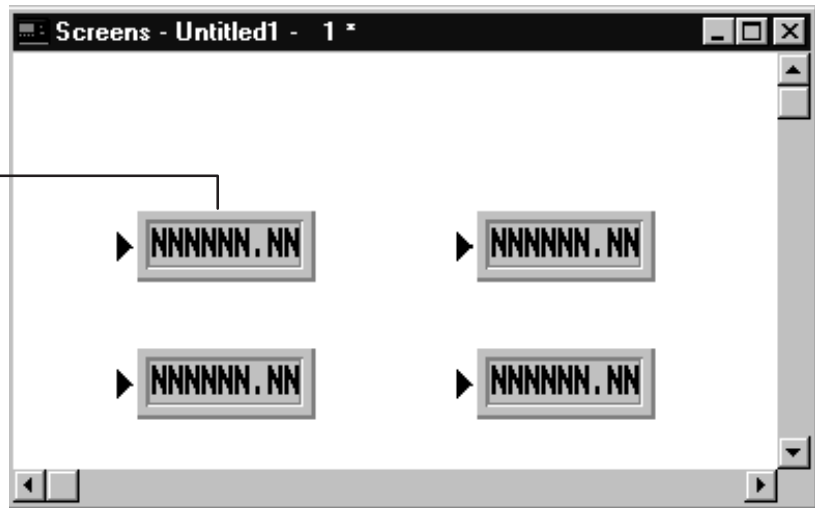


**Note:** If you assign a write expression, or configure the Numeric Keypad Enable button for implicit decimal point operation, the application will be compatible only with PanelView Version 2 or later. The application will not be compatible with earlier versions.

## Numeric Input Cursor Point (Keypad Terminals Only)

The Numeric Input Cursor Point object allows the operator to select from an array of numbers. Each Numeric Cursor Point has an associated Keypad Numeric Input control that communicates the value to the PLC. At the terminal, the keypad's arrow and Home keys are used to select a cursor point. The keypad's Select button enables the arrow and Home keys while Cancel disables them.

Numeric Input Cursor Point



Refer to the section “Cursor Point Default Operation” in the chapter on *Control Selectors*.



**Note:** Numeric Input Cursor Points can be used with Set Bit Cursor Points on the same application screen.

### Using the Numeric Input Cursor Point on the PanelView Terminal

When the application is running, the operator can use the following keys to control the Numeric Input Cursor Point:

This key	Does this
Select	Enables cursor point operation and activates the arrow and Home keys.
Arrow keys	Move the cursor to the desired Numeric Input or Set Bit Cursor Point in the screen.
Home	Moves the cursor to the Home position (the top left Numeric Input or Set Bit Cursor Point) in the screen.
Cancel	Turns off the Numeric Input Cursor Point feature and disables the keys.

# Allen-Bradley PLCs

When a Numeric Input Cursor Point is selected, the Numeric Entry scratchpad prompt “Enter New Value or Press Cancel” appears on the top of the display. The operator then uses the Numeric Keypad keys to type the new value, and presses the Enter key to send the value to the Keypad Numeric Input control. If you assign the Optional Keypad Write Expression, the PanelView terminal can perform a mathematical calculation or logical operation on the value the operator enters, and then send the result to the PLC.

If the operator uses the Raise or Lower keys while the scratchpad’s value field is blank, the Keypad Numeric Input control value is incremented or decremented directly, without the Enter key being pressed. The Raise and Lower keys are disabled as soon as a digit is entered into the Numeric Entry scratchpad. They remain disabled until the value in the scratchpad has been entered or cleared.

► **Note:** If you assign the Optional Keypad Write Expression, the Raise and Lower keys are disabled.

The operator can enter up to 16 digits in the window. By default, 5 of these are displayed. Pressing Enter validates the value. If the value entered is valid, the window clears. The new value is then sent to the PLC.

If the value is invalid, an error message appears. The value remains in the window and is not sent to the PLC. The operator must clear the error message from the display.

► **Note:** The Numeric Entry scratchpad occupies the full screen width of the top 60 pixels of the screen. When displayed, the scratchpad covers any objects in this area. Keep this in mind before you place objects in this area.

**RIO** **Important:** In Remote I/O applications, the PanelView terminal can retain the current values for the object’s controls, even after the terminal is turned off. Depending on how the Application Startup operation is defined, the retained value (last state) or initial value (default) is sent to the PLC when power is re-applied.

For details on configuring Application Startup operation, see “Application Startup” in Chapter 4 in the *PanelView 1200e and 1400e Operator Terminals User Manual*.

## Defining the Numeric Input Cursor Point Character

By default, the Numeric Input Cursor Point object uses a small arrow as the cursor character. You can change this character to either a keyboard character or a character from the extended character set.

For information about the extended characters and their ASCII codes, see Appendix B, *The Extended Character Set*, in the *PanelBuilder 1400e Configuration Software for Windows User Manual*.

- ▶ **Note:** By default, when the Cancel button is pressed at the terminal, the Numeric Input Cursor Point Character becomes invisible. To keep the character visible, even after the Cancel button is pressed, enable the Retain Cursor On Cancel check box in the Object Setup tab of the Terminal Setup dialog box. For more information about terminal setup options, see Chapter 12, “Configuring Terminal Setup Options,” in the *PanelBuilder 1400e Configuration Software for Windows User Manual*.
- ▶ **Note:** If you enable the Retain Cursor On Cancel option, the application will be compatible only with PanelView Version 3 or later. The application will not be compatible with earlier versions.

## Using the Decimal Point (Display Component)

The Numeric Input Cursor Point has both a display and an input component. See “Using the Decimal Point” later in this chapter for information about the decimal point options for the input component. The following options let you determine how the decimal point will be displayed.

- **Disabled**—Select this option if you don’t want any decimal point displayed. If the Displayed Value control contains a decimal point, it is rounded off.
- **Implicit**—The value from the Displayed Value control is displayed as it is, without any external decimal position manipulation. For example, a value of “1” is displayed as “1”. A value of “1.3” is displayed as “1.3”. If the number of digits following the decimal point is too large to fit in the display, the fraction is rounded off to fit the number of digits. For example, if the display has four digits, and the value is “1.237,” the display shows “1.24”. If an integer value or the integer portion of a number can’t be displayed fully, asterisks (\*\*\*) are displayed.

# Allen-Bradley PLCs

- **PLC Controlled**—Select this option if you want the position of the decimal point to be determined by the PLC. This means that the decimal point is not in a fixed position, and the PLC controls the number of digits after the decimal point.

If the Displayed Value control is a fractional number and has fewer than the specified number of digits, the value is padded with zeroes. If the value has more than the number of digits, the value is rounded off.

If you select this option, you must define the Displayed Decimal Point Position control.

If the PLC's value is invalid or greater than 15, this field is filled with asterisks (\*\*\*) .

- **Fixed Position**—Select this option if you want the decimal point to appear always in the same position. You must specify the number of digits to appear after the decimal point. Enter a value between 1 and 15.



**Tip:** Use Fixed Position with an analog tag that has scale and offset defined to achieve the version 5.10 Scaled Numeric Data Display capability. Or, define an expression for the Displayed Value control to achieve the same result.

## Configuring the Numeric Input Cursor Point

Configure the Numeric Input Cursor Point according to the following tables.

### Name

Field	Meaning
Name	Assign a name, up to 15 characters, to document the object for printed reports. This increases the application's size by 1 byte per character.

## Numeric Input Configuration

How you configure the numeric input determines the values the operator can enter at runtime.

Field	Meaning
Decimal Point	<p>Specify whether the operator can enter a number with decimal points.</p> <p><b>Disabled</b>—the operator can't enter a decimal point.</p> <p><b>Implicit</b>—allows the operator to enter the number and decimal point. Use an analog tag with Floating Point data type.</p> <p><b>Fixed Position</b>—you specify where the decimal point is positioned in the scratchpad display.</p> <p><b>PLC Controlled</b>—allows the PLC to determine the number of digits that appear after the decimal point by specifying a value at the Numeric Decimal Point Position control.</p> <p>The PLC Controlled decimal position can display 1 to 15 decimal digits. If the value returned by the Numeric Decimal Point Position control is outside this range, the decimal point character is replaced by a single asterisk (*).</p> <p><b>Decimal Key Controlled</b>—allows the operator to enter the number and decimal point. The terminal calculates the decimal point position and writes this value to the Numeric Decimal Point Position control.</p> <p>See "Using the Decimal Point" later in this chapter for more information.</p>
Digits after Decimal Point	<p>If you've selected the decimal point as Fixed Position, specify the number of digits to follow the decimal point, up to a maximum of 15.</p>
Auto-Repeat Rate (per second)	<p>When the operator holds down the Raise or Lower key, the terminal begins changing the value in the Keypad Numeric Input control by the specified Amount per Increment/Decrement value, at the rate entered in this field. Specify a number between 0 and 20 (per second).</p> <p>A value of 0 disables auto-repeat.</p>
Auto-Repeat Start Delay	<p>Specify the time, between 200 ms and 2.5 seconds, that the operator must hold down the Raise or Lower key before the auto-repeat function starts.</p>
Amount per Increment/Decrement	<p>Enter a value between 1 and 2,147,483,647 if the decimal point is disabled. If the decimal point is enabled, enter any value between 0.0000000001 and 2,147,483,647. The number can have a maximum of 10 digits. The decimal point is not considered a digit.</p> <p>The value at the Keypad Numeric Input control will change by this amount each time the operator presses the Raise or Lower key.</p>

Field	Meaning
Maximum Value	<p>Specify a maximum value greater than the minimum value. The range of possible values is any number between -2,147,483,647 and 2,147,483,647. The number can have a maximum of 10 digits. The decimal point is not considered a digit.</p> <p><b>Note:</b> If the Decimal Point type is Implicit, the valid range is -2,147,483,000 to 2,147,483,000. Implicit (floating-point) values are accurate up to 7 significant digits; additional digits are rounded off at the PanelView terminal.</p> <p>At runtime, if the operator enters a value above the value you specify, the terminal won't write the value to the PLC.</p>
Minimum Value	<p>Specify a minimum value less than the maximum value. The range of possible values is any number between -2,147,483,648 and 2,147,483,646. The number can have a maximum of 10 digits. The decimal point is not considered a digit.</p> <p><b>Note:</b> If the Decimal Point type is Implicit, the valid range is -2,147,484,000 to 2,147,482,000. Implicit (floating-point) values are accurate up to 7 significant digits; additional digits are rounded off at the PanelView terminal.</p> <p>At runtime, if the operator enters a value below the value you specify, the terminal won't write the value to the PLC.</p>

## Display Configuration

How you configure the display determines how the values appear to the operator at runtime.

Field	Meaning
Number of Digits	Enter the number of digits that can be displayed on the screen. The maximum number is 16.
Fill Left With	Choose whether the left portion of the display will be filled with zeroes or blank spaces when fewer than the maximum number of digits is displayed.
Decimal Point	<p>How you configure the decimal display determines the appearance of the display. It also determines the controls you must assign.</p> <p><b>Disabled</b>—Select this option if you don't want any decimal point displayed. If the Displayed Value control contains a decimal point, it will be rounded off.</p> <p><b>Implicit</b>—The value from the Displayed Value control will be displayed as it is, without any external decimal position manipulation.</p> <p><b>Fixed Position</b>—Specify where the decimal point is positioned in the numeric display. See Digits after Decimal Point, next.</p>



Field	Meaning
Decimal Point (cont)	<b>PLC Controlled</b> —Select this option if you want the position of the decimal point to be determined by the PLC. This means that the decimal point is not in a fixed position, and the PLC controls the number of digits after the decimal point. The PLC Controlled decimal position can display 1 to 15 decimal digits. If the value returned by the Displayed Decimal Point Position control is outside this range, the display field is filled with asterisks (**). See the section “Using the Decimal Point (Display Component)” earlier in this chapter for more information.
Digits after Decimal Point	If you specify the decimal point as Fixed Position, enter the number of digits that will appear after the decimal point. The maximum is 15.

### Controls

Field	Meaning
Control	<p>The Numeric Input Cursor Point uses the following controls:</p> <p><b>Keypad Numeric Input</b> identifies where the terminal writes the value to the PLC. You can assign only a tag to this control. Define this control for all Decimal Point options.</p> <p><b>Optional Keypad Write Exprn</b> performs a mathematical calculation or logical operation on the value the operator enters at the PanelView terminal, then sends the result to the Keypad Numeric Input control. Use of this control is optional. You can assign only an expression to this control. See “Using Write Expressions” later in this chapter for information about assigning this control.</p> <p><b>Numeric Decimal Point Position</b> indicates or determines the position of the decimal point.</p> <p>If you specified the decimal point as PLC Controlled, you can assign a tag or expression to this control.</p> <p>If you specified the decimal point as Decimal Key Controlled, you can assign only a tag to this control.</p> <p><b>Enter Key Control</b> and <b>Enter Key Handshake</b> are used together to provide handshaking between the PLC and the terminal. You can assign only a tag to the Enter Key Control. You can assign a tag or expression to the Enter Key Handshake control.</p> <p>See “Enter Key Handshake Operation” later in this chapter for more information about basic handshake operation.</p>

# Allen-Bradley PLCs

Field	Meaning
Control (con't)	<p>When the Raise or Lower buttons are pressed, PanelView sets the Enter Key Control (after the delay specified in the Enter Key Control Delay field in the Configure Terminal Setup dialog box) and ignores the Enter Key Handshake control. After the button is released, PanelView monitors the Enter Key Handshake control for a 0 to non-0 transition. If this does not occur within the specified Enter Key Handshake Time, a minor fault occurs. If the Raise or Lower button is released before the Enter Key Control Delay has expired, the terminal waits until that time expires before setting the Enter Key Control. After the Enter Key Control is set, the terminal monitors the Enter Key Handshake control for up to the Enter Key Handshake Time for a 0 to non-0 transition.</p> <p>The terminal resets the Enter Key Control in these situations:</p> <ul style="list-style-type: none"> <li>•an error message appears if the terminal does not receive acknowledgement (transition from 0 to another value) within the Enter Key Handshake Time specified in the Timing Parameters tab of the Configure Terminal Setup dialog box.</li> <li>•if the Enter Key Handshake is unassigned, the Enter Key Control remains set for the duration of the Push Button Hold Time if the value is entered using the Enter key. If the raise or lower keys are used, the Enter Key Control waits for the duration of the Enter Key Delay time after the Raise or Lower key is released.</li> <li>•if the handshake occurs.</li> </ul> <p>Define these controls for all Decimal Point options.</p> <p><b>Displayed Value</b> identifies the value to be displayed in the numeric display. You can assign a tag or expression to this control.</p> <p>You can assign the same tag you assigned to the Keypad Numeric Input control. Whatever value appears in this tag will be displayed. However, if you are using the Enter Key Control and Enter Key Handshake control, use a different PLC address for the Displayed Value control. You should program your PLC to read the value at the Keypad Numeric Input control and copy it to the Displayed Value control. This will provide loop-back confirmation for the value entered.</p> <p>Define this control for all Decimal Point options.</p> <p><b>Displayed Decimal Point Position</b> indicates the position of the decimal point. You can assign a tag or expression to this control.</p> <p>The value of this control determines the number of digits displayed to the right of the decimal point.</p> <p>Define this control if you specified the Decimal Point as PLC Controlled.</p>

Place successive Numeric Input Cursor Points any distance above, below, or beside existing Numeric Input Cursor Points. Refer to the X and Y coordinates in the status bar to check that the cursor point characters align properly.

When you create the screen, you'll be able to see all the cursor point characters. However, when you display the screen on a PanelView terminal, only one cursor point character will be blinking and highlighted. The display component is shown for all Numeric Input Cursor Points.

You can assign an upper and lower limit to the Numeric Input Cursor Point. These limits apply whether the value is entered using the Enter key or using the Raise and Lower keys.

- ▶ **Note:** If you assign the Optional Keypad Write Expression, the Raise and Lower keys are disabled.

You can configure a display as part of the object to provide feedback of the control's value as it is changed by the cursor point input.

You can adjust the size of the Numeric Input Cursor Point and format its foreground color, background color, font style, border style, fill style, and blink and underline attributes. For details on formatting objects see "Changing Object Appearance," in Chapter 9, *Creating Objects*, in the *PanelBuilder 1400e Configuration Software for Windows User Manual*.

- ▶ **Note:** If you use the Extra Large Font, assign a write expression, or configure the Numeric Input Cursor Point for implicit decimal point operation, the application will be compatible only with PanelView Version 2 or later. The application will not be compatible with earlier versions.

- ▶ **Note:** By default, when the Cancel button is pressed at the terminal, the Numeric Input Cursor Point Character becomes invisible. To keep the character visible, even after the Cancel key is pressed, enable the Retain Cursor On Cancel check box in the Object Setup tab of the Terminal Setup dialog box. For more information about terminal setup options, see Chapter 12, "Configuring Terminal Setup Options," in the *PanelBuilder 1400e Configuration Software for Windows User Manual*.

- ▶ **Note:** If you enable the Retain Cursor On Cancel option, the application will be compatible only with PanelView Version 3 or later. The application will not be compatible with earlier versions.

# Allen-Bradley PLCs

## Numeric Entry Keypads (Touch Screen Terminals only)

The Small or Large Numeric Entry Keypads enable an operator to send numeric data to the PLC from a touch screen terminal. If you assign the Optional Keypad Write Expression, the PanelView terminal can perform a mathematical calculation or logical operation on the value the operator enters, then send the result to the PLC.



Large Numeric Entry Keypad



Small Numeric Entry Keypad

The two keypads differ only in size. The large keypad is 384 pixels wide by 480 pixels high. The small keypad is 192 pixels wide by 480 pixels high.

Both keypads operate in exactly the same way. They include number keys, Clear, Delete, Enter, and the minus sign. The keypad may include a decimal point, depending on which Decimal Point option you choose.

**RIO Important:** In Remote I/O applications, the PanelView terminal can retain the current values for the object's controls, even after the terminal is turned off. Depending on how the Application Startup operation is defined, the retained value (last state) or initial value (default) is sent to the PLC when power is re-applied.

For details on configuring Application Startup operation, see "Application Startup" in Chapter 4 in the *PanelView 1200e and 1400e Operator Terminals User Manual*.

A maximum of 16 digits can be displayed on the scratchpad of the Small and Large Numeric Entry Keypads. The decimal point and minus sign use one digit each. The assigned tag's data type determines the range of PLC values.

## Configuring the Numeric Entry Keypad

Configure the Numeric Entry Keypad according to the following table:

Field	Meaning
Name	Assign a name, up to 15 characters, to document the object for printed reports. This increases the application's size by 1 byte per character
Type	Specify Small Numeric Entry Keypad or Large Numeric Entry Keypad.
Decimal Point	<p>Specify whether the operator can enter a number with decimal points, and how the decimal points appear in the scratchpad.</p> <p><b>Disabled</b>—the operator can't enter a decimal point.</p> <p><b>Implicit</b>—allows the operator to enter the number and decimal point. Assign an analog tag with Floating Point data type.</p> <p><b>Fixed Position</b>—you specify where the decimal point is positioned in the scratchpad display. See Digits after Decimal Point, next.</p> <p><b>PLC Controlled</b>—allows the PLC to determine the number of digits that appear after the decimal point by specifying a value at the Decimal Point Position control.</p> <p>The PLC Controlled decimal position can display 1 to 15 decimal digits. If the value returned by the Decimal Point Position control is outside this range, the decimal character is replaced by a single asterisk (*).</p> <p><b>Decimal Key Controlled</b>—allows the operator to enter the number and decimal point. The terminal calculates the decimal point position and writes this value to the Decimal Point Position control.</p> <p>For more details, see "Using the Decimal Point" earlier in this chapter.</p>
Digits after Decimal Point	If you specify the decimal point as Fixed Position, enter the number of digits that will appear after the decimal point. The maximum is 15.

Field	Meaning
Control	<p>The Numeric Entry Keypad uses the following controls:</p> <p><b>Keypad Numeric Input</b> identifies where the terminal writes the value. You can assign only a tag to this control.</p> <p><b>Optional Keypad Write Exprn</b> performs a mathematical calculation or logical operation on the value the operator enters at the PanelView terminal, then sends the result to the Keypad Numeric Input control. Use of this control is optional. You can assign only an expression to this control. See “Using Write Expressions” later in this chapter for information about assigning this control.</p> <p><b>Decimal Point Position</b> determines or indicates the position of the decimal point.</p> <p>If you specified the Decimal Point field as PLC Controlled, you can assign a tag or expression to this control.</p> <p>If you specified the Decimal Point field as Decimal Key Controlled, you can assign a tag only.</p> <p><b>Enter Key Control</b> and <b>Enter Key Handshake</b> are used together to provide handshaking between the PLC and the terminal. You can assign only a tag to the Enter Key Control. You can assign a tag or expression to the Enter Key Handshake control.</p> <p>See “Enter Key Handshake Operation” later in this chapter for more information.</p> <p><b>Important:</b> All touch screen input is disabled while the terminal is waiting for handshake acknowledgement.</p>

You can format the Numeric Entry Keypad’s foreground color and background color. For details on formatting objects see “Changing Object Appearance,” in Chapter 9, *Creating Objects*, in the *PanelBuilder 1400e Configuration Software for Windows User Manual*.

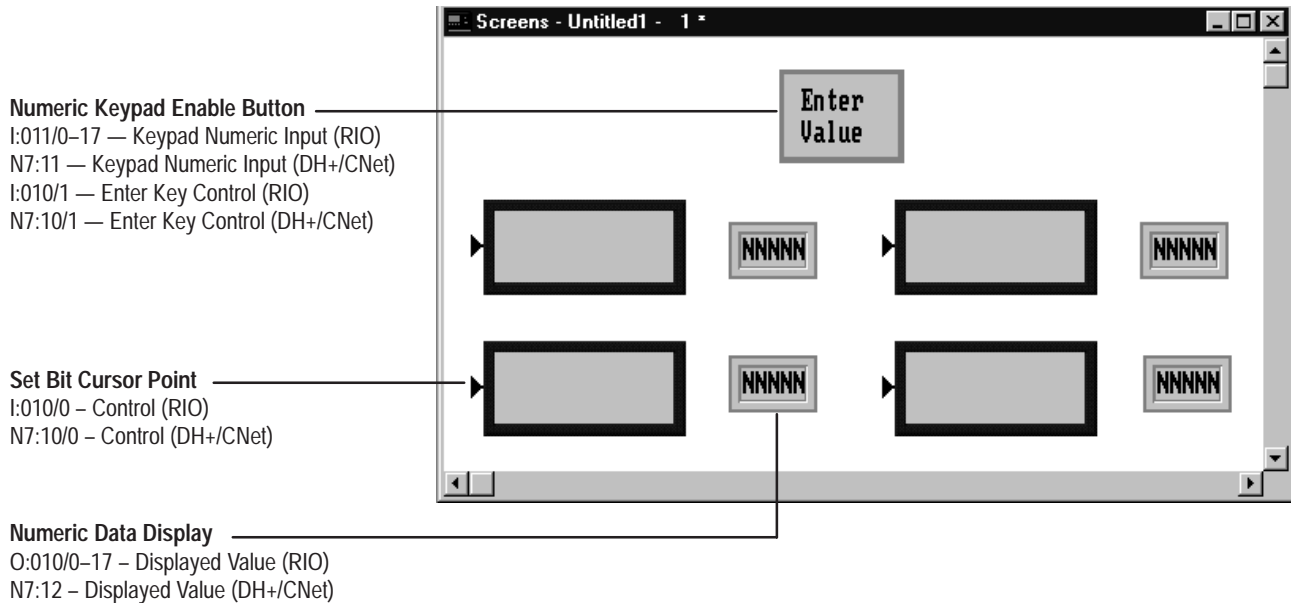


**Note:** If you assign a write expression, or configure the Numeric Entry Keypad for implicit decimal point operation, the application will be compatible only with PanelView Version 2 or later. The application will not be compatible with earlier versions.

## Examples: Editing an Array of Numeric Values

The following examples show different ways of displaying numeric values on a screen and allowing an operator to change them.

### Example 3: Set Bit Cursor Points (for keypad terminals)

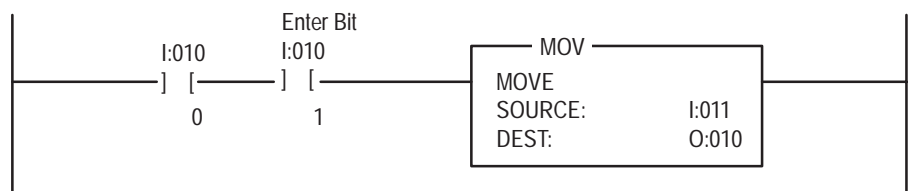


► **Note:** Although the above illustration shows both Remote I/O and DH+ or ControlNet addresses, an application can have only one type of address. The illustration is meant as an example only, for all types of applications.

The operator enters numeric values via the Numeric Keypad that appears when the Numeric Keypad Enable Button is pressed. Numeric Data Displays display values in the PLC. Set Bit Cursor Point objects are placed next to each Numeric Data Display to provide a means of selecting which value to change.

The following PLC-5/15 rungs show how the data can be read into the PLC and transferred to the corresponding Numeric Data Display.

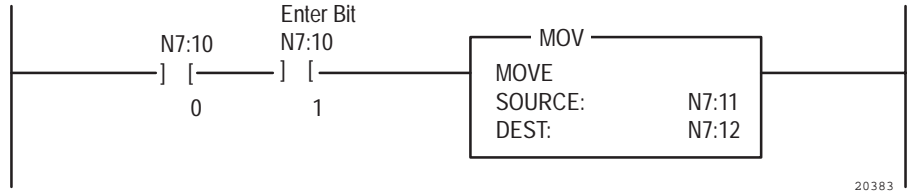
Rung for Remote I/O Application



20383

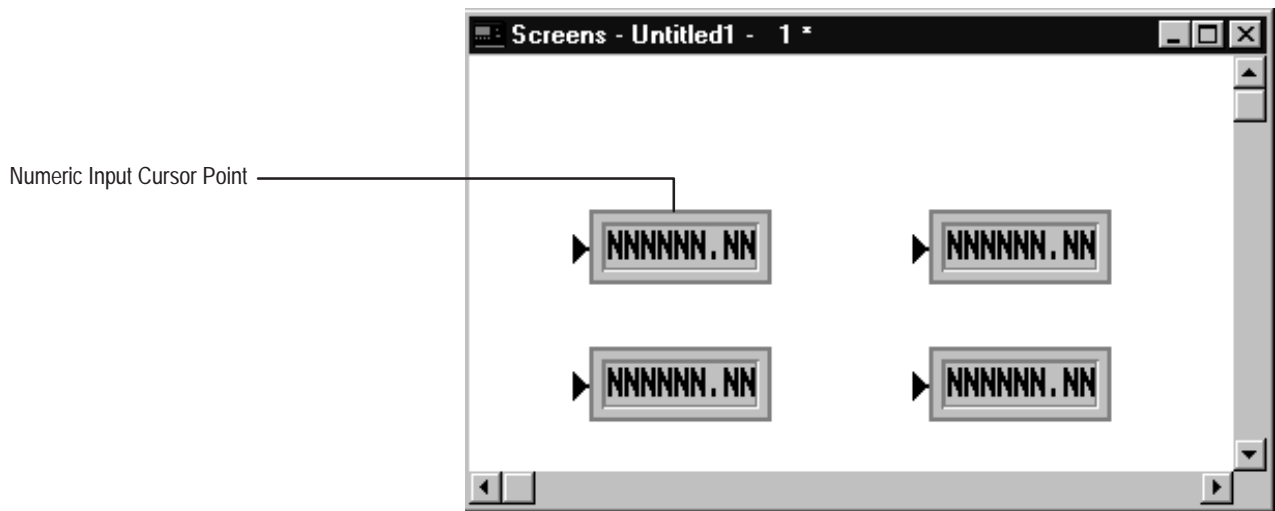
# Allen-Bradley PLCs

Rung for DH+ or ControlNet Application



To select the value to change, press the SELECT button on the PanelView terminal to enable the Set Bit Cursor Point object. Use the arrow keys to select the value, then press the Numeric Keypad Enable Button and enter the new value.

Example 4: Numeric Input Cursor Point (for keypad terminals)



Numeric Input Cursor Point objects change an array of values.

To select which value to change, press the SELECT button on the PanelView terminal to enable the Numeric Input Cursor Points and to open the scratchpad at the top of the screen. Use the arrow keys to select the value to change, then use the Numeric Keypad to enter the data in the window. Use the Enter key to send the data to the PLC.



Example 5: Numeric Entry Keypad (for touch screen terminals)

**Small Numeric Entry Keypad**

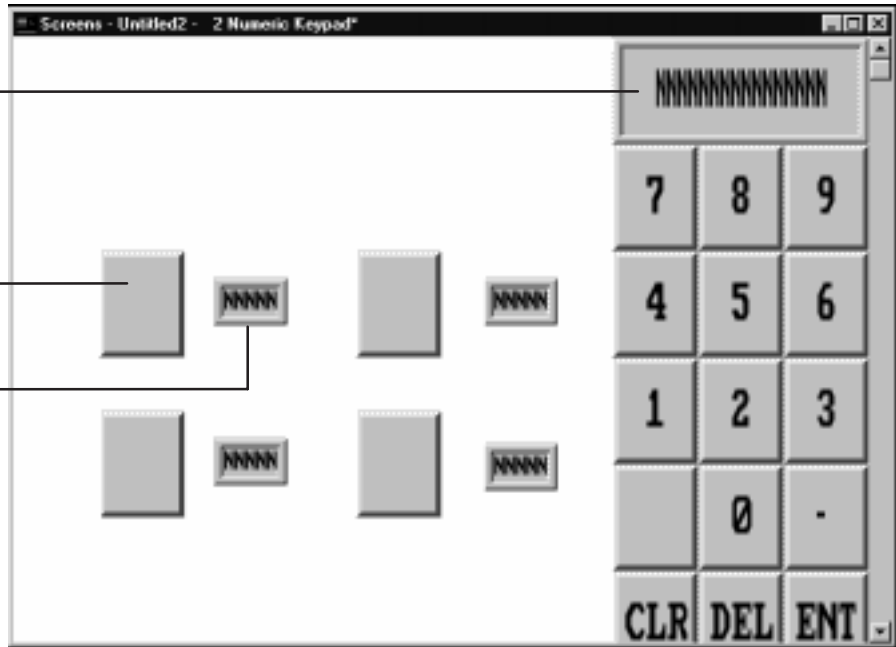
- I:011/0-17—Keypad Numeric Input (RIO)
- N7:11—Keypad Numeric Input (DH+/CNet)
- I:010/1—Enter Key Control (RIO)
- N7:10/1—Enter Key Control (DH+/CNet)

**Interlocked Push Button**

- I:012/0-17—Button Control (RIO)
- N7:13—Button Control (DH+/CNet)

**Numeric Data Display**

- O:010/0-17—Displayed Value (RIO)
- N7:12—Displayed Value (DH+/CNet)

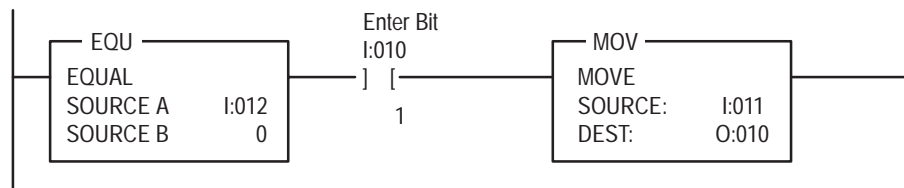


**Note:** Although the above illustration shows both Remote I/O and DH+ or ControlNet addresses, an application can have only one type of address. The illustration is meant as an example only, for all types of applications.

In this example, all numeric values are entered using one Numeric Keypad. Numeric Data Displays display the values in the PLC. Interlocked Push Buttons are placed next to each Numeric Data Display to provide a means of selecting which value to change. The Interlocked Push buttons have been given control values 0 to 3.

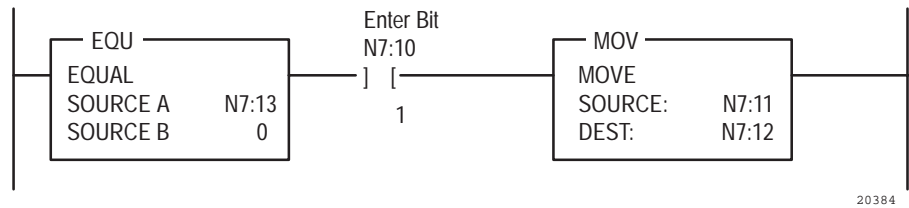
The following PLC-5/15 rungs show how the data can be read into the PLC and transferred to the corresponding Numeric Data Display.

**Rung for Remote I/O Application**



20383

## Rung for DH+ or ControlNet Application



20384

To select which value to change, press the Interlocked Push Button beside the value, and use the Numeric Keypad to enter the new value.

## Using the Decimal Point

You can determine whether or not the operator can enter numbers with decimal points in the scratchpad for the Numeric Keypad Enable Button, Numeric Input Cursor Point, and Numeric Entry Keypad objects.



**Note:** With the exception of the Implicit decimal point option, any decimal point entered is implied only. With the Implicit option, a floating-point value is written to the PLC. For all other decimal point options, the value sent to the Keypad Numeric Input control is stripped of the decimal point.

Choose from the following decimal point options:

- **Disabled** specifies no values with decimal points can be entered in the scratchpad. Only integer values can be entered.
- **Implicit** allows the operator to enter the number and decimal point. Unlike the Decimal Key Controlled option, Implicit does not use a (Numeric) Decimal Point Position control. The Keypad Numeric Input control, which uses a floating-point address in the PLC, contains all the information.

Implicit (floating-point) numbers are accurate up to 7 significant digits. Leading or trailing zeroes do not count as significant digits. If there are more than 7 significant digits, the number is rounded off. The following table illustrates how the PanelView terminal calculates the number of significant digits.

Number Entered	Number of Significant Digits	Number sent to the PLC
.000012	2	.000012
.000012345678	8	.00001234568
123.45000	5	123.45
123.45678	8	123.4568

The control you assign must use an analog tag with a Floating Point data type. If you use Device tags (for ControlNet or DH+), the tag must specify a floating-point address in the programmable controller. If you use RIO, the tag must be configured with a Block Transfer File address. For more information see Chapter 6, *Defining Tags*, in the *PanelBuilder 1400e Configuration Software for Windows User Manual*.



**Note:** If you use the Implicit option, the application will be compatible only with PanelView Version 2 or later. The application will not be compatible with earlier versions.

- **Fixed Position** specifies that a decimal point always appears in a fixed position, and a fixed number of digits is always displayed after the decimal point. You can specify the number of digits to follow the decimal point.

The number of digits after the decimal determines the minimum number of digits in the value to be sent to the control. For example, if the setting was for three digits after the decimal, an operator's entry would appear as follows:

Digits Entered	Number Displayed	Keypad Numeric Input Value (to PLC)
1	.1	100
12	.12	120
123	.123	123
1234	1.234	1234
12345	12.345	12345



**Note:** Although you can configure up to 15 digits after the decimal point, 10 or more digits may generate a Mistake message on the PanelView terminal. PanelView converts the decimal number into a signed long value, with a range of -2,147,483,648 to 2,147,483,647. If the converted number is outside this range, the Mistake message appears.

If the setting was for 15 digits after the decimal, an operator's entry would appear as follows:

Digits Entered	Number Displayed	Keypad Numeric Input Value (to PLC)
0000000000000015	0.000000000000015	15
0100000000000015	0.100000000000015	ERROR (1000000000000015)

- **PLC Controlled** allows the PLC to set the number of digits to be displayed after the decimal point.

# Allen-Bradley PLCs

If you choose the PLC Controlled decimal point, assign a Decimal Point Position control. For the Numeric Input Cursor Point object, use the Numeric Decimal Point Position control (not the Decimal Point Position control).

This control should use analog tags.

The following examples illustrate how the (Numeric) Decimal Point Position control's value affects the appearance of the scratchpad:

- If the control's value is zero, no decimal point is displayed.
- If the control's value is three, three digits are displayed to the right of the decimal point.
- If the control's value is seven, seven digits are displayed to the right of the decimal point.
- If the control's value changes, the display changes accordingly.



**Note:** If the Decimal Point control's value is greater than 15, the decimal point is replaced by a single asterisk (\*). Pressing Enter when the asterisk is displayed displays an error message.

The number of digits after the decimal determines the minimum number of digits in the value to be sent to the control. For example, if the setting was for three digits after the decimal, an operator's entry would appear as follows:

Digits Entered	Number Displayed	Keypad Numeric Input Value (to PLC)
1	.1	100
12	.12	120
123	.123	123
1234	1.234	1234
12345	12.345	12345



**Note:** Although you can configure up to 15 digits after the decimal point, 10 or more digits may generate a Mistake message on the PanelView terminal. PanelView converts the decimal number into a signed long value, with a range of -2,147,483,648 to 2,147,483,647. If the converted number is outside this range, the Mistake message appears.

If the setting was for 15 digits after the decimal, an operator's entry would appear as follows:

Digits Entered	Number Displayed	Keypad Numeric Input Value (to PLC)
0000000000000015	0.000000000000015	15
0100000000000015	0.100000000000015	ERROR (1000000000000015)

- **Decimal Key Controlled** allows the operator to enter the number and decimal point. The terminal notes the position of the decimal point and sets the Decimal Point Position control to that value.

For the Numeric Input Cursor Point object, use the Numeric Decimal Point Position control (not the Decimal Point Position control).

This control should use analog tags.

To send a decimal point value to the PLC, define a (Numeric) Decimal Point Position control. The value stored at this control determines the number of digits to the right of the decimal point. The relationship between the number and decimal point is implied; the number sent to the PLC does not contain a decimal point.

Digits Entered	Number Displayed	Keypad Numeric Input	(Numeric) Decimal Point Position Value
123	123	123	0
1.23	1.23	123	2
.12345	.12345	12345	5

## Enter Key Handshake Operation

You can assign controls to provide handshaking between the PLC and terminal for the Numeric Keypad Enable Button, Numeric Input Cursor Point, and Numeric Entry Keypad objects. To use this option, assign the Enter Key Control and the Enter Key Handshake.

When the operator presses the Enter key to send the value to the PLC, the terminal sets the Enter Key Control to 1 (after the delay specified in the Enter Key Control Delay field in the Timing Parameters tab of the Configure Terminal Setup dialog box). To inform the terminal that the handshake has been received put a rung in your PLC program to cause a 0 to non-0 transition in the value of the Enter Key Handshake control. When the terminal sees this non-0 value, it resets the Enter Key Control value.

The Enter Key Control is also reset:

- if the terminal does not receive acknowledgement (transition from 0 to a non-0 value) within the Enter Key Handshake Time specified in the Timing Parameters tab of the Configure Terminal Setup dialog box. An error message appears.
- if the Enter Key Handshake control is unassigned. The Enter Key Control remains set for the duration of the Push Button Hold Time.

# Allen-Bradley PLCs

## Using Write Expressions

Optionally, you can assign write expressions to perform a mathematical calculation or logical operation on the value the operator enters through the Numeric Keypad Enable Button, Numeric Input Cursor Point, and Numeric Entry Keypad objects. To use this option, assign the Optional Keypad Write Expression.

When the operator presses the Enter key to send the value to the PLC, the PanelView terminal performs the mathematical calculation or logical operation specified in the Optional Keypad Write Expression, then sends the result to the Keypad Numeric Input Control.

Write expressions use the same syntax as read expressions. However, you must also include the User Entry Character, to indicate the position in the expression of the value entered by the operator. The User Entry Character is the question mark symbol “?”. For example, if the operator enters a 5 at the Numeric Entry Keypad, the expression:

tag1 + ?

evaluates to the value of tag1, plus 5.

You can enter multiple question marks in the write expression, for example, if you are using a Case statement in the expression. See “Assigning Write Expressions” in Chapter 7, *Creating Expressions*, in the *PanelBuilder 1400e Configuration Software for Windows User Manual*.



**Note:** If you assign a write expression, the application will be compatible only with PanelView Version 2 or later. The application will not be compatible with earlier versions.

# Push Buttons

This chapter tells you:

- what push buttons are
- how the different types of push buttons function
- how to configure each type of push button

## About Push Buttons

Push buttons are application screen objects that function like mechanical push buttons on industrial control panels. Operators use push buttons to control processes.

There are six types of push buttons:

- Normally Open Momentary
- Normally Closed Momentary
- Latched
- Maintained
- Multistate
- Interlocked



**Note:** Some PanelBuilder objects consist of several components, including buttons. For example, Control List Selectors have two or three associated buttons. These buttons are configured as part of the object that contains them, not as independent push buttons.



**ATTENTION:** Push buttons can be used as stop buttons but not for emergency stops. Emergency stop buttons must be hard-wired.

---

## How the Different Push Buttons Work

Each push button has an assigned Button Control at the PLC. When the button is pressed, the value of this control changes and initiates an action.

The six types of push buttons differ in these ways:

- number of states
- how they respond to being pressed
- how they respond to screen changes, mode switches, and power cycles

The following table shows the differences between the push buttons:

Push Button	States	Response to button-press	Response to screen changes/mode switch	Response to power cycles
Normally Open or Closed Momentary	2	State changes to open (0) or closed (1). When released, the button returns to its initial state.	Returns to its initial state.	Returns to its initial state.
Latched	2	State changes to latched, and remains latched when released.  The button remains latched until unlatched by the handshake value from the PLC.	Returns to its initial state.	Returns to its initial state.
Maintained	2	State toggles, and remains changed when released.  Pressing the button a second time returns the button to its initial state.	Retains its changed state.	Retains its changed state or returns to its initial state, depending on the terminal's Application Startup setting.
Multistate	2 to 255	Cycles through a pre-configured set of states. Pressing the button triggers the change of state. The state's value is then written to the Button Control.	Retains its changed state.	Retains its changed state or returns to its initial state, depending on the terminal's Application Startup setting.
Interlocked	1	Usually functions as a group of buttons. Pushing one button cancels out the function of the previous button pressed, and sets the Button Control to the newly pressed button's control value.  A single Interlocked Push Button can also be used to set a value.	Retains its changed state.	Retains its changed state or returns to its initial state, depending on the terminal's Application Startup setting.

## Normally Open Momentary (N/O) Push Button



Use a Normally Open Momentary Push Button to initiate a PLC-controlled process or action.

The Normally Open Momentary Push Button controls the value at the Button Control. Normally, the control's value is 0. When the button is pressed, the control is set to 1. When the button is released, the control is reset to 0. If the button is being pressed at the moment a window (Information Message, Alarm Message, or Fault Window) appears on the screen, the button's value is reset to 0. In other words, a window appearing is treated as an automatic button release.



**Note:** You can assign more than one Normally Open Momentary Push Button to the same Button Control. Normally Open Momentary Push Buttons using the same control will function like their hard-wired equivalents wired in parallel.



This object also has an Indicator State control, used to control the display state of the object. The PanelView terminal evaluates the control and compares the result to the state values to determine which state to display.



**Note:** If the Indicator State value does not match any of the defined state values, an error state occurs and the button displays state 1 without labels. An error state also occurs if the Button Control is not assigned. In this case also, the button displays state 1 without labels.

**Important:** The Normally Open Momentary Push Button does not retain its value when power is switched off and on again, after screen changes, or when the terminal is switched to Configuration mode and then back to Run mode. The Button Control is reset to the initial state value.



**ATTENTION:** If a communication error occurs, the control value remains in its last state and the Button Control will not reset. For Remote I/O applications, the rack fault bit should be monitored when these buttons are used. For DH+ and ControlNet applications, use the active node bits in the status file. See your controller documentation for more information.



**ATTENTION:** You can use this button as a stop button but not for emergency stops. Emergency stop buttons must be hard-wired.

## Configuring the Normally Open Momentary (N/O) Button

Configure the button according to this table:

Field	Meaning
Name	Assign a name, up to 15 characters, to document the object for printed reports. This increases the application's size by 1 byte per character.
Button Type	Specify a Normally Open Momentary Push Button.
Function Key (Keypad only)	Specify which function key the operator must press to activate this button.
Number of States	Only two states are possible. The value of state 0 is fixed at 0; the value of state 1 is fixed at 1. You cannot change the number of states or their values.
Initial State	The button's initial state is fixed at 0. You cannot edit this value.

Field	Meaning
Control	<p>The Normally Open Momentary Push Button uses the following controls:</p> <p><b>Button Control</b> records the status of the button: 1 when the button is pressed and 0 otherwise. You can assign only a tag to this control.</p> <p>The Push Button Hold Time, as selected in the Timing Parameters tab of the Configure Terminal Setup dialog box, ensures that the value at this control is held for at least the specified duration.</p> <p><b>Note:</b> If you do not assign this control, an error state occurs when the object is displayed on the PanelView terminal. The button displays state 1 without its label, alerting the operator to the error state.</p> <p><b>Indicator State</b> controls the display state of the object. You can assign a tag or expression to this control.</p> <p>If you assign just the Button Control and not the Indicator State control, the button state is displayed as soon as the button is pressed and released. The feedback for this control is local and immediate. It does not necessarily reflect the Button Control's value.</p> <p>If you assign the same tag to the Button Control and Indicator State control, the terminal displays the button state based on the Button Control value. The button displays state 1 when the operator presses it, and displays state 0 when the operator releases it. This is a more reliable way of configuring the button; however, if traffic is heavy over DH+ or ControlNet, the display response may be delayed.</p> <p>To provide a visual handshake with the PLC, assign different PLC addresses to the Button Control and Indicator State control. Program the PLC to set the Indicator State control to 1 when the Button Control is 1, and the button displays state 1.</p> <p>If the Indicator State control value does not match any of the state values, an error state occurs and the button displays state 1 without labels.</p> <p>Since these controls use only two values, digital tags are recommended.</p>

You can adjust the size of the Normally Open Momentary Push Button and format its foreground color, background color, button margins (touch screen applications only), border style, fill style, and blink attributes. For details on formatting objects see “Changing Object Appearance,” in Chapter 9, *Creating Objects*, in the *PanelBuilder 1400e Configuration Software for Windows User Manual*.

## Normally Closed Momentary (N/C) Push Button



The Normally Closed Momentary Push Button controls the value at the Button Control. Normally, this control's value is 1. When the button is pressed, the control is set to 0. When the button is released, the control is reset to 1. If the button is pressed at the moment a window (Information Message, Alarm Message, or Fault Window) appears on the screen, the button's value is reset to 1.

- ▶ **Note:** You can assign two or more of these buttons to the same Button Control. When this is the case, Normally Closed Momentary Push Buttons function like their hard-wired equivalents wired in series: pressing either button, rather than both, turns off the PLC control.

This object also has an Indicator State control, used to control the display state of the object. The PanelView terminal evaluates the control and compares the result to the state values to determine which state to display.

- ▶ **Note:** If the Indicator State value does not match any of the defined state values, an error state occurs and the button displays state 1 without labels. An error state also occurs if the Button Control is not assigned. In this case also, the button displays state 1 without labels.

**Important:** The Normally Closed Momentary Push Button does not retain its value when power is switched off and on again, after screen changes, or when the terminal is switched to Configuration mode and then back to Run mode. The Button Control is reset to the initial state value.



**ATTENTION:** If a communication error occurs, the control value remains in its last state and the Button Control will not reset. For Remote I/O applications, the rack fault bit should be monitored when these buttons are being used. For DH+ and ControlNet applications, use the active node bits in the status file. See your controller documentation for more information.



**ATTENTION:** You can use this button as a stop button but not for emergency stops. Emergency stop buttons must be hard-wired.

## Configuring the Normally Closed Momentary (N/C) Button

Configure the button according to this table:

Field	Meaning
Name	Assign a name, up to 15 characters to document the object for printed reports. This increases the application's size by 1 byte per character.
Button Type	Specify a Normally Closed Momentary Push Button.
Function Key (Keypad only)	Specify which function key the operator must press to activate this button.
Number of States	Only two states are possible. The value of state 0 is fixed at 1; the value of state 1 is fixed at 0. You cannot change the number of states or their values.
Initial State	The button's initial state is fixed at 0. You cannot edit this value.
Control	<p>The Normally Closed Momentary Push Button uses the following controls:</p> <p><b>Button Control</b> records the status of the button: 0 when the button is pressed and 1 otherwise. You can assign only a tag to this control.</p> <p>The Push Button Hold Time, as selected in the Timing Parameters tab of the Configure Terminal Setup dialog box, ensures that the value at the control is held for at least the specified duration.</p> <p><b>Note:</b> If you do not assign this control, an error state occurs when the object is displayed on the PanelView terminal. The button displays state 1 without its label, alerting the operator to the error state.</p> <p><b>Indicator State</b> controls the display state of the object. You can assign a tag or expression to this control.</p> <p>If you assign only the Button Control and not the Indicator State control, the button state is displayed as soon as the button is pressed and released. The feedback for this control is local and immediate. It does not necessarily reflect the Button Control's value.</p> <p>If you assign the same tag to the Button Control and Indicator State control, the terminal displays the button state based on the Button Control value. The button displays state 1 when the operator presses it, and displays state 0 when the operator releases it. This is a more reliable way of configuring the button; however, if DH+ or ControlNet network traffic is heavy, the display response may be delayed.</p> <p>To provide a visual handshake with the PLC, assign different PLC addresses to the Button Control and Indicator State control. Program the PLC to set the Indicator State control to the value of the Button Control, and the button changes to the state with that value.</p> <p>If the Indicator State control value does not match any of the state values, an error state occurs and the button displays state 1 without labels.</p> <p>Because these controls use only two values, digital tags are recommended.</p>

You can adjust the size of the Normally Closed Momentary Push Button and format its foreground color, background color, button margins (touch screen applications only), border style, fill style, and blink attributes. For details on formatting objects see “Changing Object Appearance,” in Chapter 9, *Creating Objects*, in the *PanelBuilder 1400e Configuration Software for Windows User Manual*.

## Latched Push Button



A Latched Push Button changes state when pressed and remains in the latched state until unlatched by the PLC. This button uses a Handshake control as well as the Button Control and Indicator State control.

Pressing the button sets the Button Control to the state 1 value. When this happens, the PLC program must set the Handshake control to a non-0 value. When the terminal detects that the Handshake control has made a 0 to non-0 state transition, it resets the Button Control to the state 0 value. Your PLC must be programmed to set the Handshake control back to 0.

If the Button Control cannot accommodate the state value (if the value is too large for the control's address), an error message is displayed, and the PLC value is not changed. The operator must clear the fault before continuing.

Use the Latched Push Button when you want the Button Control to remain on until a particular process within the PLC is completed.

► **Tip:** Use a Latched Push Button if you have a PLC with long program or I/O scan times. Use the Handshake control to signal that the program has read the Button Control. You can accomplish the same thing by creating a Normally Open Momentary Push Button with a long enough Push Button Hold Time, but a Latched Push Button takes the guesswork out of estimating the program or I/O scan times, or the network responsiveness in DH+ and ControlNet applications.

► **Note:** If the Indicator State value does not match any of the defined state values, an error state occurs and the button displays state 1 without labels. An error state also occurs if the Button Control is not assigned. In this case also, the button displays state 1 without labels.

**Important:** The Latched Push Button does not retain its value when power is switched off and on again, after screen changes, or when the terminal is switched to Configuration mode and then back to Run mode. The Button Control is reset to the initial state value

**Important:** Operator screen changes are not permitted while the Button Control is set to the state 1 value (if the handshake is still outstanding). If the PLC initiates a screen change, the Button Control is reset to the state 0 value.

## Configuring the Latched Push Button

Configure the Latched Push Button according to the following table:

Field	Meaning
Name	Assign a name, up to 15 characters to document the object for printed reports. This increases the application's size by 1 byte per character.
Button Type	Specify a Latched Push Button.
Function Key (Keypad only)	Specify which function key the operator must press to activate this button.
Number of States	Only two states are possible. You cannot change this number.
Initial State	The initial state is fixed at 0. You cannot change the initial state.
Edit States	<p>Although you can't change the initial state, you can change the state values. For example, you could assign 100 to state 0, and 557 to state 1.</p> <p>To change the state values, choose Edit States. You can assign any unique value from -2,147,483,648 to 2,147,483,647. See "Configuring Object States" in Chapter 9, <i>Creating Objects</i>, in the <i>PanelBuilder 1400e Configuration Software for Windows User Manual</i> for more information.</p> <p><b>Note:</b> To minimize the size of the application file, use state values that increment by one for each state. Do not configure more states than you need.</p>
Control	<p>The Latched Push Button uses the following controls:</p> <p><b>Button Control</b> records the status of the button: state 1 value when the button is pressed and state 0 value otherwise. You can assign only a tag to this control.</p> <p><b>Note:</b> If you do not assign this control, an error state occurs when the object is displayed on the PanelView terminal. The button displays state 1 without its label, alerting the operator to the error state.</p> <p><b>Indicator State</b> controls the display state of the object. You can assign a tag or expression to this control.</p> <p>If you assign just the Button Control and not the Indicator State control, the button state is displayed as soon as the button is pressed and released. The feedback for this control is local and immediate. It does not necessarily reflect the Button Control's value.</p> <p>If you assign the same control to the Button Control and Indicator State control, the terminal displays the button state based on the Button Control value. The button displays state 1 when the operator presses it, and displays state 0 when the operator releases it. This is a more reliable way of configuring the button; however, if traffic is heavy over DH+ or ControlNet, the display response may be delayed.</p>

Field	Meaning
Control (con't)	<p>You can provide a visual handshake with the PLC by assigning different PLC addresses to the Button Control and Indicator State control. If the PLC is programmed to match the value of the Indicator State control to the value of the Button Control, the button changes to the state with that value.</p> <p>If the Indicator State control value does not match any of the state values, an error state occurs and the button displays state 1 without labels.</p> <p><b>Handshake</b> is set by the PLC to confirm that it has recorded the change for the Button Control. You can assign a tag or expression to this control. A digital tag is recommended.</p> <p>The PanelView terminal sets the Button Control to the state 1 value when the operator presses the button. PLC logic must set the Handshake control to a non-0 value when the Button Control is set. When the terminal detects a 0 to non-0 transition in the Handshake control, it resets the Button Control to state 0. PLC logic must then reset the Handshake control to 0.</p> <p>If the Handshake control is not assigned, the Button Control value remains at the state 1 value.</p>

You can adjust the size of the Latched Push Button and format its foreground color, background color, button margins (touch screen applications only), border style, fill style, and blink attributes. For details on formatting objects see “Changing Object Appearance,” in Chapter 9, *Creating Objects*, in the *PanelBuilder 1400e Configuration Software for Windows User Manual*.

## Maintained Push Button



A Maintained Push Button has two states. It changes state when pressed and remains in the changed state when released. Pressing the button a second time changes the button back to its original state. This button is also known as “Push-On, Push-Off.”

When the application first runs, the Maintained Push Button is in its initial state. When the button is pressed, the corresponding Button Control is set to its other state’s value. The control remains set even after the button is released. The operator must press the button a second time to reset the control to the initial state value.

If the Button Control cannot accommodate the state value (if the value is too large for the control’s address), an error message is displayed, and the PLC value is not changed. The operator must clear the fault before continuing.



**Note:** If the Indicator State value does not match any of the defined state values, an error state occurs and the button displays state 1 without labels. An error state also occurs if the Button Control is not assigned. In this case also, the button displays state 1 without labels.

**RIO Important:** In Remote I/O applications, depending on how the Application Startup screen is configured, the PanelView terminal can retain the current value for the button setting even after the terminal is turned off. For this reason, don't use a Maintained Push Button to initiate a PLC-controlled machine or process. Instead use a Latched or Momentary Push Button.

## Configuring the Maintained Push Button

Configure the Maintained Push Button according to the following table:

Field	Meaning
Name	Assign a name, up to 15 characters to document the object for printed reports. This increases the application's size by 1 byte per character.
Button Type	Specify a Maintained Push Button.
Function Key (Keypad only)	Specify which function key the operator must press to activate this button.
Number of States	Only two states are possible. You cannot change this number.
Initial State	<p>You can assign either state to be the button's initial state. This state's value will be written to the Button Control when the application is run for the first time. This value will override the control's initial value.</p> <p>You don't need to assign any state as the initial state. You can instead assign the button's initial state to be blank. If you do, the object will write the tag's initial value to the Button Control.</p>
Edit States	<p>If you wish, you can edit the values of each state. For example, you could assign 100 to state 0, 200 to state 1.</p> <p>To change the state values, choose Edit States. You can assign any unique value from -2,147,483,648 to 2,147,483,647. See "Configuring Object States" in Chapter 9, <i>Creating Objects</i>, in the <i>PanelBuilder 1400e Configuration Software for Windows User Manual</i> for more information.</p> <p><b>Note:</b> To minimize the size of the application file, use state values that increment by one for each state. Do not configure more states than you need.</p>
Control	<p>The Maintained Push Button uses the following controls:</p> <p><b>Button Control</b> records the status of the button. You can assign only a tag to this control.</p> <p>When the button is first pressed, the control is set to the value of the state not configured as the initial state. This value remains until the button is pressed a second time, resetting the control to the initial state value.</p> <p>The button is aware of external control value changes. If the Button Control value changes to one that does not match any of the state values, the next button pressed sets the button to state 0.</p>



Field	Meaning
Control (con't)	<p><b>Note:</b> If you do not assign this control, an error state occurs when the object is displayed on the PanelView terminal. The button displays state 1 without its label, alerting the operator to the error state.</p> <p><b>Indicator State</b> controls the display state of the object. You can assign a tag or expression to this control.</p> <p>If you assign just the Button Control and not the Indicator State control, the button state is displayed as soon as the button is pressed and released. The feedback for this control is local and immediate. It does not necessarily reflect the Button Control's value.</p> <p>If you assign the same tag to the Button Control and Indicator State control, the terminal displays the button state based on the Button Control value. The button displays state 1 when the operator presses it, and displays state 0 when the operator presses it again. This is a more reliable way of configuring the button; however, if traffic is heavy over DH+ or ControlNet, the display response may be delayed.</p> <p>You can provide a visual handshake with the PLC by assigning different PLC addresses to the Button Control and Indicator State control. If the PLC is programmed to match the value of the Indicator State control to the value of the Button Control, the button changes to the state with that value.</p> <p>If the Indicator State control value does not match any of the state values, an error state occurs and the button displays state 1 without labels.</p>

You can adjust the size of the Maintained Push Button and format its foreground color, background color, button margins (touch screen applications only), border style, fill style, and blink attributes. For details on formatting objects see “Changing Object Appearance,” in Chapter 9, *Creating Objects*, in the *PanelBuilder 1400e Configuration Software for Windows User Manual*.

## Multistate Push Button



The Multistate Push Button enables the operator to send a pre-configured series of values to the PLC.

Each button state can be configured with different attributes such as text and graphic image labels and colors.

At runtime, if the Button Control cannot accommodate the state value (if the value is too large for the control's address), an error message is displayed, and the PLC value is not changed. The operator must clear the fault before continuing.



**Note:** If the Indicator State value does not match any of the defined state values, an error state occurs and the button displays the highest state without labels. An error state also occurs if the Button Control is not assigned. In this case also, the button displays the highest state without labels.

**RIO Important:** In Remote I/O applications, depending on how the Application Startup screen is configured, the terminal can retain the current value for the button setting even after the terminal is turned off. For this reason, don't use a Multistate Push Button to initiate a PLC-controlled machine or process. Use a Momentary Push Button instead.

### Configuring the Multistate Push Button

Configure the Multistate Push Button according to the following table:

Field	Meaning
Name	Assign a name, up to 15 characters, to document the object for printed reports. This increases the application's size by 1 byte per character.
Button Type	Specify a Multistate Push Button.
Function Key (Keypad only)	Specify which function key the operator must press to activate this button.
Number of States	Assign from 2 to 255 states to the button. If you increase the number of states from the default of 2, you must assign state values. To do so, choose Edit States, described below.
Initial State	<p>You can assign any state to be the button's initial state. This state's value is written to the Button Control when the application runs for the first time. This value overrides the control's initial value.</p> <p>You don't need to assign any state as the initial state. You can instead assign the button's initial state to be blank. If you do, the object writes the tag's initial value to the Button Control.</p>
Edit States	<p>If you wish, you can edit the values of each state. For example, if you assign three states, you could assign 100 to state 0, 200 to state 1, and 57 to state 3.</p> <p>To assign different values to the states, choose Edit States. Assign a unique value from -2,147,483,648 to 2,147,483,647 for each state. See "Configuring Object States" in Chapter 9, <i>Creating Objects</i>, in the <i>PanelBuilder 1400e Configuration Software for Windows User Manual</i> for more information.</p> <p><b>Note:</b> To minimize the size of the application file, use state values that increment by one for each state. Do not configure more states than you need.</p>
Auto-Repeat Rate	Specify how many times the button will repeat per second, if held down. A value of 0 disables auto-repeat.
Auto-Repeat Start Delay	Specify how long the button must be held down before it starts to auto-repeat.

Field	Meaning
Control	<p>The Multistate Push Button uses the following controls:</p> <p><b>Button Control</b> records the status of the button. You can assign only a tag to this control.</p> <p>When the application runs for the first time, the value of the initial state is written to the Button Control. Each time the button is pressed, the value of the next state is sent to the Button Control. After the value for the last state is sent, the next button press wraps back to the first state.</p> <p>The button recognizes external control value changes. If the Button Control value changes to one that does not match any of the state values, the next button pressed sets the button to state 0.</p> <p><b>Note:</b> If you do not assign this control, an error state occurs when the object is displayed on the PanelView terminal. The highest state is displayed without its label, alerting the operator to the error state.</p> <p><b>Indicator State</b> controls the display state of the object. You can assign a tag or expression to this control.</p> <p>If you assign just the Button Control and not the Indicator State control, the button state is displayed as soon as the button is pressed and released. In this case, the feedback for this control is local and immediate. It does not necessarily reflect the Button Control's value.</p> <p>You can assign the same tag to the Button Control and Indicator State control. In this case, the terminal displays the button state based on the Button Control value. This is a more reliable way of configuring the button; however, if traffic is heavy over DH+ or ControlNet, the display response may be delayed.</p> <p>You can provide a visual handshake with the PLC by assigning different PLC addresses to the Button Control and Indicator State control. If the PLC is programmed to match the value of the Indicator State control to the value of the Button Control, the button changes to the state with that value.</p> <p>If the Indicator State control value does not match any of the state values, an error state occurs and the button displays the highest state without its label.</p>

You can adjust the size of the object and format its foreground color, background color, button margins (touch screen applications only), border style, fill style, and blink attributes. For details on formatting objects see “Changing Object Appearance,” in Chapter 9, *Creating Objects*, in the *PanelBuilder 1400e Configuration Software for Windows User Manual*.

## Interlocked Push Button



An Interlocked Push Button is one of a group of buttons that have the same control. The buttons function together in much the same way as the station selector buttons on a car radio: pressing one cancels the other and makes a new selection. Although Interlocked Push Buttons function as a group, you must add them to the screen one at a time.

When the operator presses an Interlocked Push Button, the PanelView terminal places the button's control value at the Button Control address in the PLC and highlights the selected button.

The Interlocked Push Button remains highlighted as long as the PLC value is the same as the value of the button. Therefore only one button in the group is active and highlighted at any time.

If two or more Interlocked Push Buttons have the same control value, both are highlighted whenever the associated Button Control contains that value.

► **Note:** If the Button Control value does not match any of the Interlocked Push Buttons' Control Values, an error state occurs and no button is highlighted. An error state also occurs if the Button Control is not assigned. In this case also, no button is highlighted.

You can use different groups of Interlocked Push Buttons on the same screen, as long as each group uses a different Button Control.

► **Note:** You can also add a single Interlocked Push Button to the screen. When pressed, it sends its control value to the PLC. This acts as a Set Value Button.

**RIO Important:** In Remote I/O applications, the PanelView terminal can retain the current value for the button setting, even after the terminal is turned off. Depending on how the Application Startup operation is defined, the retained value (last state) or initial value (default) is sent to the PLC when power is re-applied.

For details on configuring Application Startup operation, see "Application Startup" in Chapter 4 in the *PanelView 1200e and 1400e Operator Terminals User Manual*.

► **Tip:** While a Control List Selector with Enter Key serves a similar purpose, you have much more flexibility in placing Interlocked Push Buttons on your screen.

## Configuring the Interlocked Push Button

Configure each Interlocked Push Button according to this table:

Field	Meaning
Name	Assign a name, up to 15 characters to document the object for printed reports. This increases the application's size by 1 byte per character.
Control Value	Enter a value from -2,147,483,648 to 2,147,483,647. This value should be unique for each button in the group.
Function Key (Keypad only)	Specify which function key the operator must press to activate this button.
Control	<p><b>Button Control</b> records the status of the button. You can assign only a tag to this control.</p> <p>You define a series of Interlocked Push Buttons to function as a group. Assign the same tag to each button. When the operator presses an Interlocked Push Button, the Control Value is written to the Button Control and the button appears highlighted. The button remains highlighted for as long as the value at the tag remains the same as the Control Value.</p> <p><b>Note:</b> If you do not assign this control, an error state occurs when the object is displayed on the PanelView terminal. No button is highlighted, alerting the operator to the error state.</p>

You can adjust the size of the Interlocked Push Button and format its foreground color, background color, button margins (touch screen applications only), border style, fill style, and blink attributes. For details on formatting objects see “Changing Object Appearance,” in Chapter 9, *Creating Objects*, in the *PanelBuilder 1400e Configuration Software for Windows User Manual*.

## Scales

This chapter tells you about:

- what scales are used for
- how to configure scales

### About Scales



A scale consists of a line with ticks, used to provide an illustrative measurement scale beside bar graphs and Trend objects. You can create vertical and horizontal scales across the height or width of the screen.

Vertical scales can be configured so the ticks extend from left to right or vice versa. Horizontal scales can be configured so the ticks extend from bottom to top or vice versa.

► **Note:** If you use scales, the application will be compatible only with PanelView Version 2 or later. The application will not be compatible with earlier versions.

► **Tip:** Use the following suggestions to customize scales:

- Position text labels on or near the scale object for static descriptions, or use display objects for changing descriptions.
- Specify the number of major and minor ticks to reflect accurately the range of values in the bar graph or Trend object. For example, if a bar graph has a minimum value of 0 and a maximum value of 50, you could specify 6 major ticks for the scale, and 9 minor ticks between each major tick.
- To have a scale use different colors for different value ranges, cascade scales together. To do this, remove the border from the scales, place the high end of one scale at the low end of the next, and adjust each scale's color accordingly. To add a border to the cascading scales, place a hollow or solid panel behind the scales.
- Group scales with other objects to create a fully functional "template." For example, position two or three pairs of scales and bar graphs together and put numeric display objects immediately below the scale/bar graph pairs to display the process variable, set point, and control variable.

## Configuring the Scale

Configure the scale according to this table:

Field	Meaning
Tick Direction	Specify the direction in which you want the ticks to extend from the line. For vertical scales specify either Left or Right. For horizontal scales specify either Up or Down.
Major Ticks	Specify the number of major ticks on the line. Major ticks are twice the length of minor ticks. The range is from 2 to 20. If you choose 2, one mark appears at either end of the scale.
Minor Ticks	Specify the number of minor ticks between each major tick. Minor ticks are half the length of major ticks. The range is from 0 to 20.

You can adjust the size of the scale and format its foreground color, background color, border style, line style, fill style, and blink attributes. For details on formatting objects see “Changing Object Appearance,” in Chapter 9, *Creating Objects*, in the *PanelBuilder 1400e Configuration Software for Windows User Manual*.

## Screen Print Buttons

This chapter tells you:

- how the Screen Print Button works
- how to configure the Screen Print Button

### About Screen Print Buttons



The Screen Print Button is a static object; it doesn't interact with the PLC. The operator uses the Screen Print Button to print the current screen. When this button is pressed, a monochrome bitmap image of the screen is sent to the printer. If a window is open, the window is printed also.

**Important:** Only Epson® FX-80 compatible printers are supported.



**Note:** For best print results, design the screens you intend the operator to print with black text on a white screen background.

Screen print requests are ignored when the printer is already busy with a previous screen print. Enabling the Screen Print Active to PLC option in the PLC I/O Control Options dialog box allows the PanelView terminal to inform the PLC that a screen print is in progress. For details on setting this option, as well as information about screen prints, see Chapter 12, *Configuring Terminal and PLC Options*, in the *PanelBuilder 1400e Configuration Software for Windows User Manual*.

The PLC can also trigger screen prints. If the PLC-controlled screen print and screen change happen at the same time, the current screen is printed before the screen changes.

### Configuring the Screen Print Button

Configure the Screen Print Button according to this table:

Field	Meaning
Name	Assign a name, up to 15 characters, to document the object for printed reports. This increases the application's size by 1 byte per character.
Function Key (Keypad only)	Specify which function key the operator must press to activate this button.



You can adjust the size of the Screen Print Button and format its foreground color, background color, button margins (touch screen applications only), border style, fill style, and blink attributes. For details on formatting objects see “Changing Object Appearance,” in Chapter 9, *Creating Objects*, in the *PanelBuilder 1400e Configuration Software for Windows User Manual*.

# Allen-Bradley PLCs

## Screen Selectors

This chapter tells you about:

- the different types of Screen Selectors
- how to configure the Screen Selectors

### About Screen Selectors

Screen Selectors are static objects; they don't interact with the PLC. At runtime, the operator uses Screen Selectors to move to another screen, or to return to a previously displayed screen. Every screen should have a Screen Selector, so an operator is not stranded at a particular screen.



**Note:** Enabling the Screen Number Change to PLC option in the PLC I/O Control dialog box allows the PanelView terminal to inform the PLC of a new screen.

There are five types of Screen Selectors:

This Screen Selector	Does this
"Goto Screen" button	Displays the screen associated with the button.
"Return to Previous Screen" button	Returns to the screen displayed previously.
Screen List Selector	Allows the operator to select from a list of screens.
Screen Select Keypad (Touch Screen terminals only)	Allows the operator to choose the next screen to be displayed by entering its number on the screen's keypad.
Screen Keypad Enable button (Keypad terminals only)	Allows the operator to choose the next screen to be displayed by entering its number on the terminal's numeric keypad.

Depending on how the application is configured, the operator can't always use these objects to control screen changes. The operator can't change the screen when:

- the PLC Controlled Screen Change option is enabled and the value of the associated control is not 0
- "Minimum Push Button Hold Time," "Latch Button PLC Handshakes" or "Enter Key Handshakes" are outstanding
- the screen is security-coded, and the operator doesn't have authority to access it

If one of these situations occurs, or if the operator selects a screen that does not exist, an error message is displayed and the screen does not change.

You can use screen selectors to call up any screens in the application, including Alarm History and Alarm Status screens.

## Goto Screen and Return to Previous Screen Buttons



When the operator presses the Goto Screen button, the screen associated with the button is displayed. When the operator presses the Return to Previous Screen button, the previously displayed screen re-appears.

**Tip:** Include a Goto Screen button labeled “View Current Status” in a screen and configure the button to go to a screen displaying the current status. That screen would include a Return to Previous Screen button, so the operator could easily return. For a touch screen application, configure a Goto Screen button labeled “Select New Screen” to go to a screen displaying a Screen Select Keypad. For a keypad application, use a Screen Keypad Enable button. The operator could then select the desired screen by entering the screen number.



**Note:** The PanelView terminal remembers only the last screen. You can’t back up through a succession of screens with Return To Previous Screen buttons.

**Important:** In PanelBuilder, if you delete or renumber a screen that is assigned to Goto Screen buttons, you must assign a new screen to each of the affected buttons. Otherwise the application will not run properly.

### Configuring the Goto Screen and Return to Previous Screen Buttons

Configure the Goto Screen and Return to Previous Screen buttons according to this table:

Field	Meaning
Name	Assign a name, up to 15 characters, to document the object for printed reports. This increases the application's size by 1 byte per character.
Button Type	Select Goto Screen Button or Return to Previous Screen Button.
Go to Screen	For Goto Screen buttons, specify which screen will be displayed when the operator presses this button.
Function Key (Keypad only)	Specify which function key the operator must press to activate this button.

You can adjust the size of the buttons and format their foreground color, background color, button margins (touch screen applications only), border style, fill style, and blink attributes. For details on formatting objects see “Changing Object Appearance,” in Chapter 9, *Creating Objects*, in the *PanelBuilder 1400e Configuration Software for Windows User Manual*.

## Screen List Selector



With a Screen List Selector, the operator presses Up and Down buttons to scroll through a list of screen names, then presses the Enter key to switch to a selected screen. The Screen List Selector is similar to the Control List Selector with Enter Key, but it is used to control screen changes.

**Note:** The size of the Selector List object’s list component determines the number of screens you can display. To increase or decrease the number, you must resize the list. For information on resizing the list, see Chapter 9, *Creating Objects*, in the *PanelBuilder 1400e Configuration Software for Windows User Manual*. You’ll also find information on adding list text in that chapter.

The Screen List Selector consists of the following components:

This component	Does this
List	Displays up to 24 different items (12 with Double High or Large font; 6 with Extra Large font) in a vertical list. You can use only one font size. Using a border decreases the maximum possible number of items.
Up Cursor	Moves the arrow indicator up one entry in the list. Because only one of the Up and Down Cursors must be enabled, you can disable this cursor.
Down Cursor	Moves the arrow indicator down one entry in the list. Because only one of the Up and Down Cursors must be enabled, you can disable this cursor.
Enter	Changes to the selected screen.

## Configuring the Screen List Selector

Configure the Screen List Selector according to this table:

Field	Meaning
Name	Assign a name, up to 15 characters, to document the object for printed reports. This increases the application's size by 1 byte per character.
Up Cursor	Specify whether the Up Cursor is enabled, and, if you have a keypad application, which function key it uses. You must have at least one of the Up and Down Cursor keys enabled.
Down Cursor	Specify whether the Down Cursor is enabled, and, if you have a keypad application, which function key it uses. You must have at least one of the Up and Down Cursor keys enabled.
Enter (Keypad only)	Specify which function key the operator will press to select the highlighted choice.
Screens	The list must have at least 2 lines or states, to a maximum of 24 (0 – 23 states). To assign a screen to a state, highlight the line for the state and choose Assign Screen. The Assign Screen dialog box appears. Choose the screen to assign to this state from the list of existing screens.

You can adjust the size each component of the Screen List Selector and format the object's foreground color, background color, font style, button margins (touch screen applications only), border style, fill style, and blink attributes. For details on formatting objects see "Changing Object Appearance," in Chapter 9, *Creating Objects*, in the *PanelBuilder 1400e Configuration Software for Windows User Manual*.



**Note:** If you use the Extra Large font, the application will be compatible only with PanelView Version 2 or later. The application will not be compatible with earlier versions.

# Allen-Bradley PLCs

## Screen Select Keypad (Large and Small) (Touch Screen Terminals Only)



A Screen Select Keypad is a numeric keypad that enables the operator to choose the next screen to be displayed by entering its number.

**Tip:** Configure a Goto Screen button labeled “Select New Screen” to go to a screen displaying a Screen Select Keypad. The operator can then select the desired screen by entering the screen number.

Screen Select Keypads come in two sizes: the large keypad is 384 pixels wide, while the small keypad is 192 pixels wide. Both keypads are 480 pixels high, and both operate in the same way.

The following table lists and explains the object’s components.

This component	Does this
Enter	Removes the current screen and displays the screen with the screen number that was in the scratchpad.
Scratchpad	Shows the screen number being entered.
Delete	Deletes the most recent digit entered.
Number keys	Specify the number of the screen to select.
Clear	Clears the scratchpad.

### Configuring the Screen Select Keypad

Configure the Screen Select Keypad according to this table:

Field	Meaning
Name	Assign a name, up to 15 characters, to document the object for printed reports. This increases the application’s size by 1 byte per character.
Type	Specify Large Screen Select Keypad or Small Screen Select Keypad.

You can format the Screen Select Keypad’s foreground color and background color. For details on formatting objects see “Changing Object Appearance,” in Chapter 9, *Creating Objects*, in the *PanelBuilder 1400e Configuration Software for Windows User Manual*.

## Screen Keypad Enable Button (Keypad Terminals Only)



This button allows the operator to choose the next screen to be displayed by entering the screen number on the terminal's numeric keypad.

At runtime, when the button is pressed, a scratchpad appears on the top 60 pixels of the screen. The operator enters the screen number in the scratchpad using the terminal's numeric keypad.

The keys on the numeric keypad function as follows:

This key	Does this
Enter	Removes the scratchpad and current screen and displays the screen with the screen number that was in the scratchpad.
Number keys	Enter numbers in the scratchpad.
Delete	Deletes the last digit entered in the scratchpad.
Cancel	Removes the scratchpad and cancels the screen change.



**Note:** Operator input is disabled for a short time when the scratchpad is first displayed. This may result in a delay before the first digit can be entered.

### Configuring the Screen Keypad Enable Button

Configure the Screen Keypad Enable Button according to this table:

Field	Meaning
Name	Assign a name, up to 15 characters, to document the object for printed reports. This increases the application's size by 1 byte per character.
Function Key	Specify which function key the operator must press to activate this button.

You can adjust the size of the Screen Keypad Enable Button and format its foreground color, background color, fill style, and blink attributes. For details on formatting objects see "Changing Object Appearance," in Chapter 9, *Creating Objects*, in the *PanelBuilder 1400e Configuration Software for Windows User Manual*.

## Scrolling Lists

This chapter tells you about:

- the different Scrolling List components
- how to configure the components

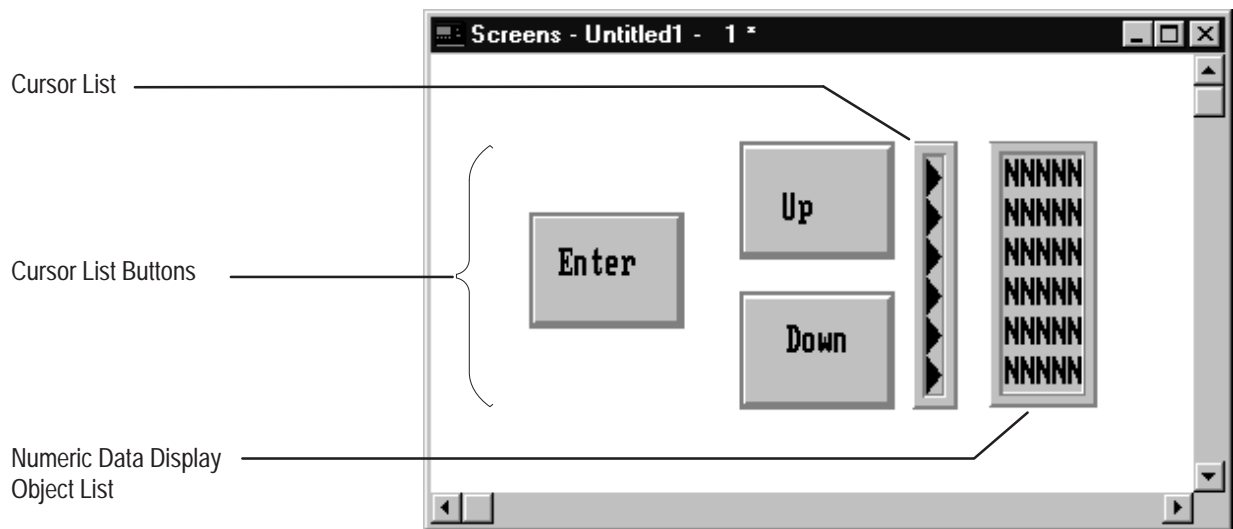
### About Scrolling Lists

The Scrolling List object allows you to define and view a list that is bigger than the screen. The Scrolling List consists of a Cursor List and one or more Object Lists. You can use the cursor buttons to move through a maximum of 999 items within these object lists. Each screen can have only one Cursor List. However, you can define multiple object lists. These object lists include:

- Multistate Indicator Object Lists
- Local Message Object Lists
- Numeric Data Display Object Lists

**Important:** For the Scrolling List object to function, you must group the Cursor List and all object lists on the screen.

The following illustration shows how a Scrolling List could appear:



The Scrolling List permits PLC output data to be multiplexed to the PanelView terminal. This reduces the PLC ladder logic typically needed to display and edit large amounts of data.



**Important:** Depending on how the Scrolling Lists in the application are configured, the terminal can retain the last (that is, most current) list state for all the Cursor List and Object List settings even after the terminal is turned off. See *Configuring Retained Last List States*, later in this chapter, for more information.

## Cursor List

How you define the Cursor List determines how you can define the Object Lists. Therefore, create and configure the Cursor List before you create any of the Object Lists.

You use three dialog boxes to configure the Cursor List:

- **Configure Cursor List**—In this dialog box you assign the number of states, configure the button-repeat times, configure whether to retain the last list state, and assign controls. You can also access the Configure Cursor List Buttons and Configure Cursor List States dialog boxes from this dialog box.
- **Configure Cursor List Buttons**—In this dialog box you enable or disable the different navigation buttons available for the Cursor List object. Access this dialog box from the Configure Cursor List dialog box by choosing Edit Buttons.
- **Configure Cursor List States**—In this dialog box you assign state values to the states in the list, and specify whether any of the states will be skipped. Access this dialog box from the Configure Cursor List dialog box by choosing Edit States.

## Configuring the Cursor List

Configure the Cursor List according to the following table:

Field	Meaning
Name	Assign a name, up to 15 characters, to document the object for printed reports. This increases the application's size by 1 byte per character.
Number of States	Specify the total number of states or items in the Scrolling List object. The valid range is from 2 to 999. This value cannot be less than the Number of Visible States defined for the object.  You can accept the default state values, or assign different values to each state, as described in this chapter.

Field	Meaning
Number of Visible States	<p>Define the height of the scrollable list that is visible to the operator. The valid range is from 1 to 24. The value you enter cannot be greater than the Number of States defined for the object and must be greater than the Number of Preview States.</p> <p>You can also configure the number of visible states by sizing the Cursor List graphically. See Chapter 9, <i>Creating Objects</i>, in the <i>PanelBuilder 1400e Configuration Software for Windows User Manual</i> for details.</p> <p><b>Note:</b> You cannot size the Cursor List to accommodate fewer states than the number of the highest assigned Visible State control. For example, if you assigned a tag to Visible State 5, you cannot graphically size the list to display fewer than 5 states. If you size the list to display fewer than 5 states by entering a lower number in the Number of Visible States field, you will receive a warning, and, if you choose to proceed, Visible State controls with a higher number will be deleted.</p> <p>Each visible state can have a Visible State control assigned.</p>
Number of Preview States	<p>Define the minimum number of visible states above or below the cursor before the list begins to scroll.</p> <p>The minimum number you can enter is 0. See <i>Configuring Preview States</i>, later in this chapter, for information about the maximum Number of Preview States.</p>
Auto-Repeat Rate (per second)	<p>Set the number of times per second the Up, Down, Page Up, and Page Down cursor buttons will repeat when pressed and held down by the operator. Valid values are between 0 and 20. A value of 0 disables auto-repeat.</p>
Auto-Repeat Start Delay	<p>Set the time that should pass before the Up, Down, Page Up, and Page Down cursor buttons go into Auto-Repeat mode when pressed and held down by the operator. Valid values are between 200 milliseconds and 2.5 seconds.</p>
Retain Last List State	<p>Select Yes or No. If you select Yes, PanelView retains the last (that is, most current) list state for the Cursor List and related Object Lists even after a screen change, mode change, or after the terminal is turned off. If you choose No, the list state for the Cursor List and related Object Lists are not retained even after a screen change, mode change, or after the terminal is turned off.</p> <p>See <i>Configuring Retained Last List States</i>, later in this chapter, for more information.</p> <p><b>Note:</b> If you select Yes, the application will be compatible only with PanelView Version 2 or later. The application will not be compatible with earlier versions.</p>

## Configuring Preview States

The Number of Preview States you define for a cursor list determines the minimum number of visible states that will appear above or below the cursor before the list begins to scroll.

In PanelBuilder, Version 2, the maximum Number of Preview States is calculated differently than in earlier versions. The following table illustrates the different calculation methods:

Formula for Maximum Number of Preview States, pre-Version 2	Formula for Maximum Number of Preview States, Version 2
Number of Visible States/2 - 1	(Number of Visible States + 1)/2 - 1



**Note:** If you use a maximum number that is higher than the number obtained using the earlier method, the application will be compatible only with PanelView Version 2 or later. The application will not be compatible with earlier versions.

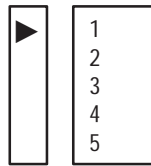
The following table illustrates the different results produced by the two methods:

Number of Visible States	Maximum Number of Preview States, pre-Version 2	Maximum Number of Preview States, Version 2
5	$5/2 - 1 = 1.5 = 1$ (rounded down)	$(5 + 1)/2 - 1 = 2$
6	$6/2 - 1 = 2$	$(6 + 1)/2 - 1 = 2.5 = 2$ (rounded down)

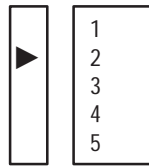
The following illustration shows an example of how the preview state option works when the Number of States is 7, the Number of Visible States is 5, and the Number of Preview States is 1.

# Allen-Bradley PLCs

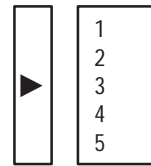
1. Home Position



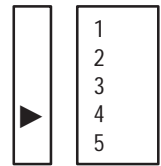
2. Cursor Down



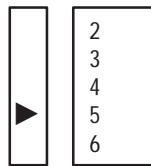
3. Cursor Down



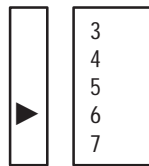
4. Cursor Down



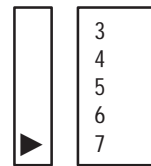
5. Cursor Down



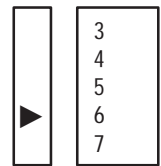
6. Cursor Down



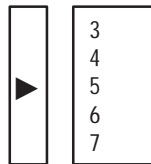
7. Cursor Down



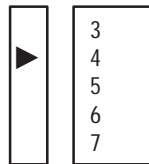
8. Cursor Up



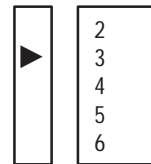
9. Cursor Up



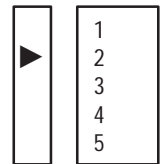
10. Cursor Up



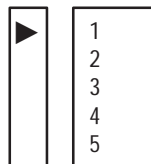
11. Cursor Up



12. Cursor Up



13. Cursor Up



23664

## Configuring Retained Last List States

PanelBuilder, Version 2 allows you to configure applications so that PanelView retains the last (that is, most current) list state for the Cursor List and related Object Lists, even after a screen change, mode change, or after the terminal is turned off. If you choose not to retain the last list states, they will not be retained at screen change, mode change, or after the terminal is turned off. Specify whether to Retain Last List State in the Configure Cursor List dialog box.

If a screen contains a Cursor List that has a Retain Last List State value, when you display the screen PanelView positions the cursor on that state's value, and sends the value to the Cursor Indicator control. PanelView then updates the Top Position and Visible State controls.

► **Note:** A Cursor List will not have a Retain Last List State value until its parent screen has been displayed, or if the application has been newly selected as the current application. If it has no Retain Last List State value, and the list is under operator control, PanelView positions the cursor on the Cursor Indicator state value, if non-skipped. Otherwise, PanelView positions the cursor on the first non-skipped state. See *Configuring Skipped States*, later in this chapter, for more information.

► **Note:** If the PLC controls the list, the PanelView terminal ignores any Retained Last List State values. In this case, the list position is determined by the Cursor List control. PanelView then updates the Cursor Indicator, Top Position, and Visible State controls.

**Important:** When the operator switches to a new screen, there could be a slight delay before the Cursor List values are updated from the PLC.

If you load Application Initial Values in Configure Mode, the Retain Last List State values will be cleared. However, Application Startup settings have no effect on Retain Last List State values.

► **Note:** If you choose Yes to Retain Last List States, the application will be compatible only with PanelView Version 2 or later. The application will not be compatible with earlier versions.

## The Cursor List Controls

The Cursor List object uses the following controls:

Control	Meaning
Cursor Control from PLC	<p>Lets the PLC inform the terminal where to position the cursor in the Scrolling List. The control contains the value of the state to place the cursor on. You can assign a tag or expression to this control. The control, Enable PLC Controlled List, must be on (non-0) for this control to work.</p> <p><b>Note:</b> For the PLC to control the cursor, the value of the Enable PLC Controlled List must be non-0. Pressing the cursor buttons at the terminal will generate a Mistake message.</p> <p><b>Note:</b> If no state matches the Cursor Control value, or if the value points to a skipped state, an error state occurs and the arrow cursor and highlight bar disappear.</p>

Control	Meaning
Cursor Indicator to PLC	<p>This control informs the PLC of the cursor's location in the Scrolling List. You can assign only a tag to this control. The control contains the value of the state that the cursor is pointing to. The terminal updates this value when the cursor position changes.</p> <p>If the Enable PLC Controlled List value is 0 (under the operator's control), the Cursor List buttons control the Cursor Indicator value. If the Enable PLC Control value is not 0 (and the list is therefore under the control of the PLC), the Cursor Indicator value reflects the Cursor Control value.</p> <p><b>Note:</b> For the PLC to control the cursor, the value of the Enable PLC Controlled List must be non-0. Pressing the cursor buttons at the terminal will generate a Mistake message.</p> <p><b>Important:</b> Do not share the Cursor Indicator tag with other objects. Shared tags can cause unpredictable results.</p>
Top Position to PLC	<p>This control informs the PLC of the value of the state displayed at the top of the Cursor List. You can assign only a tag to this control. This value directs the PLC to the value that should be placed in the first or "Top" Visible State control of the object lists.</p> <p><b>Important:</b> Do not share the Top Position tag with other objects. Shared tags may cause the PLC to display the wrong range of numbers.</p>
Enter Key Control and Enter Key Handshake	<p>These controls work together to provide handshaking between the PLC and the terminal. You can assign only a tag to the Enter Key Control. You can assign a tag or expression to the Enter Key Handshake.</p> <p>When the operator presses the Enter button, the terminal sets the Enter Key Control to 1 (after the Enter Key Control Delay specified in the Timing Parameters tab of the Configure Terminal Setup dialog box). Put a line in your PLC program to cause a 0 to non-0 transition in the Enter Key Handshake's value, to inform the terminal that the Enter Key Control value has been received. When the terminal sees this value, it sets the Enter Key Control's value to 0.</p> <p>If the terminal does not receive acknowledgment (transition from 0 to another value) within the specified delay time, it displays an error message in the Fault Window and resets the Enter Key Control to 0. If the Enter Key Handshake is unassigned, the Enter Key Control will remain set for the duration of the Push Button Hold Time or for as long as the button is pressed, whichever is longer.</p>
Enable PLC Controlled List	<p>This control informs the terminal whether the PLC or the terminal operator (using the Scrolling List buttons) controls the cursor list. You can assign a tag or expression to this control. If the control's value is 0, the operator controls the cursor using the buttons. If the value is other than 0, the PLC controls the cursor, using the Cursor Control value.</p> <p><b>Note:</b> For the PLC to control the cursor, the value of the Enable PLC Controlled List must be non-0. Pressing the cursor buttons at the terminal generates a Mistake message.</p> <p><b>Note:</b> If you don't assign the Enable PLC Controlled List, ensure that you have at least one of the Cursor List buttons enabled, because the operator must be able to control the cursor.</p>
Visible State	<p>This control is assigned for each configured visible state. You can assign only tags to this control. The state value for each visible state is sent to the PLC via its control.</p>

## Configuring Cursor List State Values

To configure the Cursor List State Values, choose Edit States in the Configure Cursor List dialog box. Configure the Cursor List State Values according to the following table.

Column	Meaning
State Value	<p>Assign a value to each state the Cursor List will use. Also assign values to skipped states. To assign different values to the states, choose Edit States. You can assign any unique value from -2,147,483,648 to 2,147,483,647.</p> <p>For more information, see "Configuring List Object States" in Chapter 9, <i>Creating Objects</i>, in the <i>PanelBuilder 1400e Configuration Software for Windows User Manual</i>.</p>
Skip State	<p>Specify whether this state will be skipped. If you choose Yes, neither the PLC nor the operator can select it. When the operator scrolls through the Cursor List, the cursor will skip the state.</p> <p>If the Cursor List is under PLC control, and the PLC sends a state value for a skipped state to the terminal, the terminal treats the value as invalid and removes the arrow cursor and highlight. The terminal will not send a value to the Cursor Indicator control. However, if the state is a visible state, the state's value will still be written to the Visible State control. See "<i>Configuring Skipped States</i>," earlier in this chapter, for more information.</p> <p><b>Note:</b> If you choose Yes to assign skipped states, the application will be compatible only with PanelView Version 2 or later. The application will not be compatible with earlier versions.</p>

The state values you assign determine how the Cursor List object operates at runtime, that is, whether the PLC or the Cursor List has primary control over the Object List values.

- If the PLC has main control over the Object List values, the Cursor List object lets the operator use a set of control values stored in your PLC ladder logic.

To have the Cursor List operate this way, assign consecutive state values in ascending order, starting from 1 for State 0. Also assign the Top Position and Cursor Indicator controls. These controls inform the PLC of the top-most visible state displayed and the state the cursor is pointing to. The PLC can then determine the values to be sent to the Object Lists.

Assign the Enable PLC Control, Cursor Control, Enter Key Control, and Enter Key Handshake control as needed. With this configuration, the Cursor List's Visible State controls are not needed and can be left unassigned.

See the keypad demonstration file provided with PanelBuilder 1400e for an example of a Cursor List that is configured this way. If you followed the default installation, the file is in the \AB\PB1400E\DEMO directory. The Scroll List screen contains a Cursor List grouped with several Object Lists.

# Allen-Bradley PLCs

- ▶ **Note:** If the Cursor List is under PLC control, and the PLC sends a state value that does not match any of the defined state values, an error state occurs and the arrow cursor and highlight bar are removed. An error message appears.

If the control values are stored in the Cursor List, the Cursor List routes these values to the PLC. The PLC in turn routes the values to the Object Lists.

To have the Cursor List operate this way, assign values to the Cursor List states, in the order most suitable for your application. Assign the Visible State controls. These controls will be updated with the state values of the currently displayed visible states. The PLC can route these directly to the Object Lists' Visible State controls.

Assign the Cursor Indicator control to inform the PLC of the current cursor position. Assign the Enable PLC Control, Cursor Control, Enter Key Control, and Enter Key Handshake control as needed. Because the Top Position control is not needed, leave it unassigned.

- ▶ **Note:** When this configuration is used in a DH+ or ControlNet application, the Scrolling List's performance can be somewhat slow if the number of visible states is large.

### Configuring Skipped States

PanelBuilder, Version 2, allows you to configure individual states as "skipped." While skipped states appear in the Scrolling List, neither the operator nor the PLC can select them. When the operator scrolls through the Cursor List, the cursor skips the state.

For example, you can configure the first and last states in the list to be skipped, so that these states act as a "buffer" to prevent the cursor from going to the very top or very bottom of the list.

- ▶ **Note:** You cannot configure every state to be skipped. At least one state must not be skipped.

Skipped states cannot have the same value as a non-skipped state. PanelBuilder will report a validation error if a skipped state has the same value as a non-skipped state. However, skipped states can have the same value as other skipped states. For example, you could assign every skipped state the value 0.



If the Cursor List is under PLC control, and the PLC sends a state value for a skipped state to the terminal, the terminal treats the value as invalid and removes the arrow cursor and highlight. An error message appears. The terminal does not send a value to the Cursor Indicator to PLC control. Nothing on the Cursor List is highlighted until the PLC sends a value for a non-skipped state.



**Note:** If you use skipped states, the application will be compatible only with PanelView Version 2 or later. The application will not be compatible with earlier versions.

### Configuring the Cursor List Buttons

The Scrolling List object supports several buttons that control the cursor position of the Cursor List and of all the Object Lists. Specify the buttons for the Scrolling List in the Cursor List object.

You can enable or disable any or all of the buttons, move them to different locations on the screen, change their colors, and add labels (text or bitmaps).

To configure the Cursor List Buttons, choose Edit Buttons in the Configure Cursor List dialog box. Configure the Cursor List Buttons according to the following table.

Field	Meaning
Up Cursor	Specify whether the Up Cursor button is enabled, and, if you have a keypad application, select a function key.  Up Cursor moves the cursor to the previous non-skipped state in the scrolling list. If the cursor is at the top-most or first position in the list, or if all previous states are skipped states, pressing this button has no effect.
Down Cursor	Specify whether the Down Cursor button is enabled, and, if you have a keypad application, select a function key.  Down Cursor moves the cursor to the next non-skipped state in the scrolling list. If the cursor is at the bottom-most or last position in the list, or if all remaining states are skipped states, pressing this button has no effect.

Field	Meaning
Page Up	<p>Specify whether the Page Up button is enabled, and, if you have a keypad application, select a function key.</p> <p>Page Up scrolls up the list by the defined Number of Visible States. The cursor is in the same position on the new page unless that position is occupied by a skipped state. In that case, the cursor is placed on the first non-skipped state on the new page. If no non-skipped states appear on the page, PanelView scrolls another Page Up until a non-skipped state is found. If the cursor is at the top-most or first non-skipped position in the list, pressing this button has no effect.</p>
Page Down	<p>Specify whether the Page Down button is enabled, and, if you have a keypad application, select a function key.</p> <p>Page Down scrolls down the list by the defined Number of Visible States. The cursor is in the same position on the new page unless that position is occupied by a skipped state. In that case the cursor is placed on the first non-skipped state on the new page. If no non-skipped states appear on the page, PanelView scrolls another Page Down until a non-skipped state is found. If the cursor is at the bottom-most or last non-skipped position in the list, pressing this button has no effect.</p>
Home	<p>Specify whether the Home button is enabled, and, if you have a keypad application, select a function key.</p> <p>Home positions the cursor at the top-most or first non-skipped position in the list. The configured Number of Preview States appear above the cursor if sufficient skipped states are defined to appear above the first non-skipped state.</p>
End	<p>Specify whether the End button is enabled, and, if you have a keypad application, select a function key.</p> <p>End positions the cursor at the bottom-most or last non-skipped position of the list. The configured Number of Preview States appear below the cursor if sufficient skipped states are defined to appear below the last non-skipped state.</p>
Enter	<p>The Enter button is always visible, but it is enabled only when the Enter Key Control is set. If you have a keypad application, select a function key.</p> <p>If the Enter Key Control is defined (in the Configure Cursor List dialog box), the terminal sets this control's value after the Enter button is pressed (after the Enter Key Control Delay time specified in the Timing Parameters tab of the Configure Terminal Setup dialog box). If the Enter Key Handshake control is defined, the terminal resets the Enter Key Control when the Enter Key Handshake makes a transition from 0 to another value after the Enter Key Control is set. If the Enter Key Handshake control does not make this transition within the specified time, the terminal displays a message, and automatically resets the Enter Key Control. If the Enter Key Handshake is not defined for this object, the Enter Key Control is reset when the Push Button Hold Time elapses.</p>



**Note:** Except for the Enter button, the cursor buttons are active only when the value of the Enable PLC Control for the Cursor List is set to 0. If this value is other than 0, the PLC controls the cursor. The Enter button is always active, regardless of the state of the Enable PLC Control. Pressing a cursor button at the terminal while the PLC controls the Cursor List generates a Mistake message at the terminal.

## Configuring the Cursor List Font

You can apply most of the font sizes in the Format menu to the Cursor List; the only font you cannot use for Cursor Lists is the Extra Large font. The font height you choose determines the size of the list. A Large or Double High font doubles the vertical size of the list, reducing the number of entries by half. If the font is Large or Double High, the maximum number of visible states is 12. If not, it is 24.



**Note:** All Object Lists should have the same font height as the Cursor List. If screen space is limited, use a smaller font.

## Optimizing Scrolling List Performance

The Scrolling List object operates faster in Remote I/O applications than in DH+ and ControlNet applications. If your application is configured for DH+ or ControlNet, the following tips will help maximize performance:

- The Scrolling List performs faster if Visible State write tags are not used. If Visible State tags are used, assign as few visible states as possible.
- If there are several visible states, use the Top Position to PLC and Cursor Indicator to PLC controls, and keep control values for the list at the PLC instead of with the Cursor List Object.
- Use a low auto-repeat rate, because the Scrolling List repeats one at a time only. How fast it can repeat depends on the DH+ or ControlNet network traffic.

You can adjust the size of each component of the Cursor List and format the object's foreground color, background color, font style, button margins (touch screen applications only), border style, fill style, and blink attributes. You cannot use the Extra Large Font for the Cursor List or its object lists. For details on formatting objects see "Changing Object Appearance," in Chapter 9, *Creating Objects*, in the *PanelBuilder 1400e Configuration Software for Windows User Manual*.

# Allen-Bradley PLCs

## Object Lists

An Object List consists of a list of objects of the same type. The Object Lists and the Cursor List together make up the Scrolling List. You can create any number of Object Lists for each screen, as long as there is sufficient space on the screen.

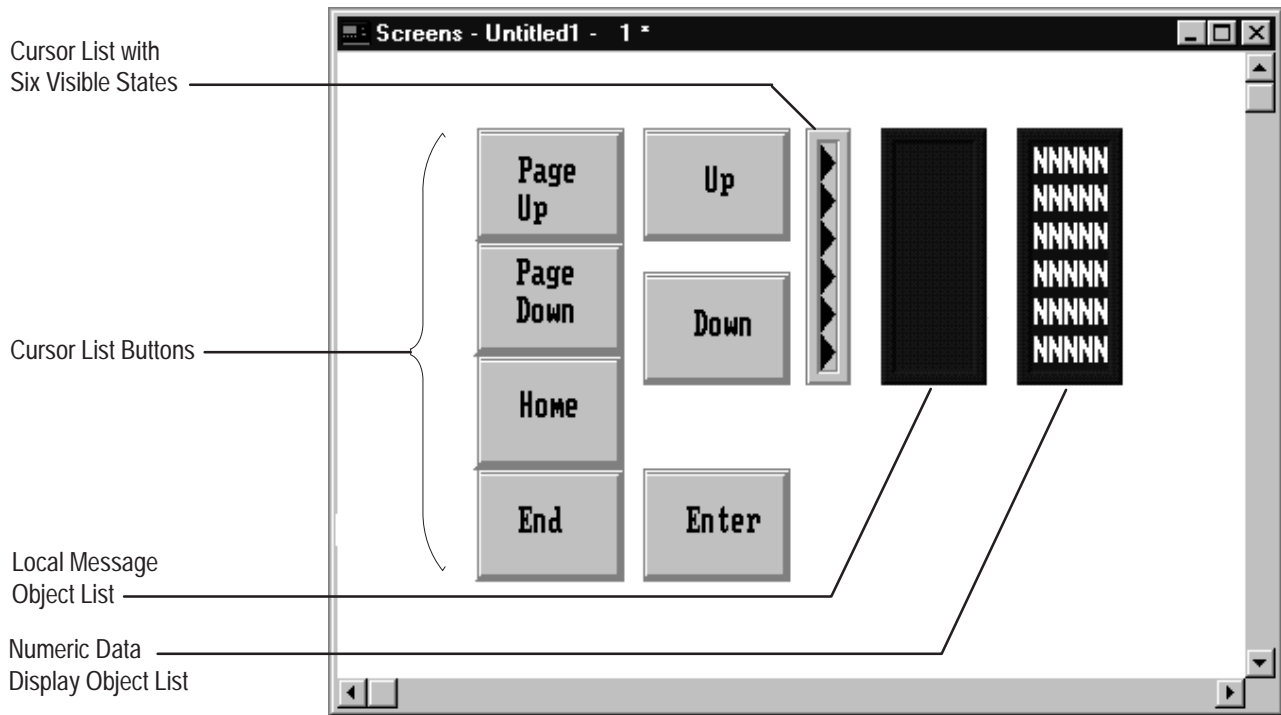
Although you define the Cursor List and Object List components separately, they are in fact components of a single Scrolling List object.

An object list can have up to 24 visible states. Each visible state constitutes one object. You can't configure individual visible states; the configuration applies to all objects in the list.

The number of items in each object list is determined by the Number of Visible States specified in the Cursor List. You can choose from three types of Object Lists:

- **Multistate Indicator Object List**—This Object List consists of individual Multistate Indicator objects.  
The Multistate Indicator objects can have up to 255 different states. You can define only one set of state labels per Multistate Object List.
- **Local Message Object List**—This Object List is a list of individual Local Message Display objects.
- **Numeric Data Display Object List**—This Object List is a list of individual Numeric Data Display objects.  
You can define only one type of numeric display for each Numeric Data Display Object List.

The following illustration shows a sample Scrolling List object, consisting of a cursor list and two object lists. The number of visible states is the same for all three lists.



- ▶ **Note:** Use the same font height (font sizes Large and Double High are the same height; Small and Double Wide are the same height) for the object lists that you use for the cursor list. Otherwise PanelBuilder will display a validation error. You must also group the cursor list and its Object List together before downloading the file, to avoid validation errors.

The Object List's width determines the size of the objects to be displayed in the list:

- For Multistate Indicator Object Lists, the size of the state label determines the appropriate width of the list.
- For Local Message Object Lists, the minimum width should be the longest defined message that will be displayed.
- For Numeric Display Data Object Lists, the minimum width depends on the range of values you are expecting to display.

- ▶ **Note:** You can size the Object List height to increase or decrease the number of Visible States. However, you cannot size the Object List to accommodate fewer states than the number of the highest assigned Visible State control. For example, if you assigned a tag to Visible State 5, you cannot size the list to display fewer than 5 states. If you size the list to display fewer than 5 states by entering a lower number in the Number of Visible States field, you will receive a warning, and, if you choose to proceed, Visible State controls with a higher number will be deleted.

# Allen-Bradley PLCs

## Multistate Indicator Object List

Each Multistate Indicator object in the Multistate Indicator Object List allows the operator to view the state of a PLC operation on the screen. The Number of Visible States you define for the Multistate Indicator Object List must be the same as for the Cursor List.

Because the objects function as a list, they are configured as a group. You can define from 2 to 255 states for the objects. For each state, you can define unique labels, colors and attributes, using text and bitmap images. The PanelView terminal then monitors the Visible State control and displays the state labels and colors appropriate to the control value.

### Configuring Labels for Multistate Indicator Object Lists

As part of configuring the Multistate Indicator Object List, you may want to add text or graphic images to different states.




**Note:** To add a graphic image, you can use monochrome or color bitmaps, but not PanelBuilder drawing objects.

By default the text is configured as Small Font. You can change the font size. Different states can have different font sizes. However, you cannot use the Extra Large font for Scrolling List objects.

The lines of text, the font size, and the maximum size of the graphic image depend on whether or not the Double Height States option is selected in the Configure Multistate Indicator Object List dialog box.

- If the Double Height States option is not selected, you can enter only a single line of Small or Double Wide text. You can add graphic images that are 20 pixels or less in height.
- If the Double Height States option is selected you can enter a single line of Large or Double High text, or two lines of Small or Double Wide text. You can add graphic images that are 40 pixels or less in height.

### To change the text font to Double High or Large:

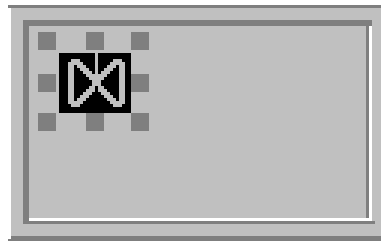
1. Draw the Multistate Indicator Object List.
2. Select the Double Height States option in the Configure Multistate Indicator Object List dialog box.
3. Select Text from the Object menu, or  from the toolbox.
4. Choose the text size you want from the Format menu.
5. Click the I-beam in the Multistate Indicator Object List. The cursor automatically appears at the top of the list. If you selected Double Height States, and you are using the Small or Double Wide font, the cursor can appear on the first or second line of the object, depending on where you click.
6. Type the text. It is automatically formatted as a label, and you cannot move the text outside the boundaries of the object.
7. With the Multistate Indicator Object List selected, select the next state to format. Either select from the list box on the tool bar, or choose Next State from the View menu.
8. Repeat steps 1 through 6 to add text to the next state. Or, follow the steps in the next section to add a graphic image.

### To add a graphic image as a label:

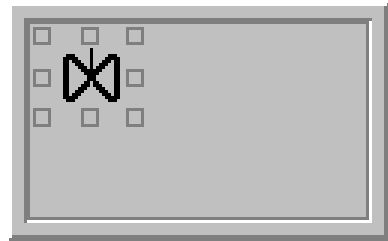
1. Place the graphic image on the screen, and move it into the Multistate Indicator Object List. Position the image near the top of the object. For information on importing, placing, and moving graphic images, see Chapter 9, *Creating Objects*, in the *PanelBuilder 1400e Configuration Software for Windows User Manual*.

Depending on how close to the top of the object you position the graphic image, it may be repositioned and converted into a label automatically.

If the selected graphic image is surrounded by solid handles, it is still an independent graphic. If the handles are solid, go to step 2. If the handles are hollow, it is a label.



Independent Graphic



Label

# Allen-Bradley PLCs

2. With the graphic image selected, choose Make Label from the Edit menu.

A message informs you if the image is too large to fit into the line; if this message appears, the image is not converted to a label.

If the image is not converted to a label, and you know the image is small enough, move the graphic image closer to the top of the object and choose Make Label again.



**Note:** To deselect the Double Height States option after you have entered Double High or Large text, two lines of text, or a graphic image that is larger than 20 pixels, change the text size, delete the second line of text, or remove the graphic image. Remember that you must do this for every state with Large or Double High text, or two lines of text.

## Configuring the Multistate Indicator Object List

Configure the Multistate Indicator Object List according to the following table:

Field	Meaning
Name	Assign a name, up to 15 characters, to document the object for printed reports. This increases the application's size by 1 byte per character.
Number of States	Specify the number of states this object will display, from 2 to 255. You can specify different values for each state. To do so, choose Edit States in the dialog box. You can assign any unique value from -2,147,483,648 to 2,147,483,647. For more information on configuring states, see "Configuring List Object States" in Chapter 9, <i>Creating Objects</i> , in the <i>PanelBuilder 1400e Configuration Software for Windows User Manual</i> .  For each state, you should configure colors, labels, and other attributes.  <b>Note:</b> To minimize the size of the application file, use state values that increment by one for each state. Do not configure more states than you need.
Number of Visible States	Define the number of objects from the whole list that the operator can see at any given time. For the scrolling list to be valid, the Number of Visible States must be the same as the Cursor List's Number of Visible States.
Double Height States	Check this box if you want each list state to appear twice as large as normal. If you choose this option, each list item doubles in size. Note that Double Height States reduce the maximum number of visible states to 12. The states' height should be the same as that of the Cursor List.
Control	<b>Visible State</b> controls allow you to attach an individual control to each visible object or state in the list. You can assign tags or expressions to these controls.



You can adjust the size of the Multistate Indicator Object List and format its background color, border style, and blink attributes. For details on formatting objects see “Changing Object Appearance,” in Chapter 9, *Creating Objects*, in the *PanelBuilder 1400e Configuration Software for Windows User Manual*.

After you configure the Multistate Indicator Object List and any other object lists that are part of the same Scrolling List, group the object lists with the Cursor List. You must group all the components of the Scrolling List at the same time or PanelBuilder will report a validation error. For more information about grouping objects see Chapter 9, *Creating Objects*, in the *PanelBuilder 1400e Configuration Software for Windows User Manual*.

For an example of how to configure Multistate Indicator Object Lists that would be displayed with your Cursor List, see “Scrolling List Example” at the end of this chapter.

## Local Message Object List

The number of Local Message objects in a list is determined by the Number of Visible States you defined for the Cursor List. The list should be wide enough to accommodate the longest Local Message on a single line.

### Configuring the Local Message Object List

Configure the Local Message Object List according to the following table:

Field	Meaning
Name	Assign a name, up to 15 characters, to document the object for printed reports. This increases the application's size by 1 byte per character.
Number of Visible States	Define the number of objects that the operator can see at any given time. For the scrolling list to be valid, the Number of Visible States must be the same as the Cursor List's Number of Visible States.
Highlight Bar	Check this box if you want the current state (controlled by the Cursor Control or cursor buttons) to appear highlighted in reverse video.
Control	<b>Visible State</b> controls are used to attach an individual control to each visible object or state in the list. You can assign tags or expressions to these controls.

# Allen-Bradley PLCs

You can adjust the size of the Local Message Object List and format its foreground color, background color, font style, and blink and underline attributes. You cannot use the Extra Large Font for the Local Message Object List. For details on formatting objects see “Changing Object Appearance,” in Chapter 9, *Creating Objects*, in the *PanelBuilder 1400e Configuration Software for Windows User Manual*.

After you configure the Local Message Object List and any other object lists that are part of the same Scrolling List, group the object lists with the Cursor List. You must group all the components of the Scrolling List at the same time or PanelBuilder will report a validation error. For more information about grouping objects see Chapter 9, *Creating Objects*, in the *PanelBuilder 1400e Configuration Software for Windows User Manual*.

For an example of how to configure Local Message Object Lists that would be displayed with your Cursor List, see “Scrolling List Example” at the end of this chapter.

## Numeric Data Display Object List

The number of Numeric Data Display objects in a list is determined by the Number of States you defined for the Cursor List.

### Configuring the Numeric Data Display Object List

Configure the Numeric Data Display Object List according to the following table:

Field	Meaning
Name	Assign a name, up to 15 characters, to document the object for printed reports. This increases the application's size by 1 byte per character.
Fill Left With	You can choose whether the left portion of the display will be filled with zeros or blank spaces, when fewer than the maximum number of digits is displayed.
Number of Digits	Specify the number of digits to display, up to a maximum of 16. Keep in mind that a decimal point and minus sign each take the place of one digit. If you choose to display several digits after the decimal point, be sure to take these into account also.
Number of Visible States	Define the number of objects that the operator can see at any given time. For the scrolling list to be valid, the Number of Visible States must be the same as the Cursor List's Number of Visible States.
Highlight Bar	Select this option if you want the current state (controlled by the Cursor Control or cursor buttons) to appear highlighted.

Field	Meaning
Decimal Display	<p>How you configure the decimal display and polarity determines the appearance and behavior of the Numeric Data Display. It also determines the controls you must assign. Each Numeric Data Display Object List can have only one configuration.</p> <p><b>Disabled</b>—Check this button if you don't want a decimal point displayed. If the Visible State value contains a decimal point, it is rounded off.</p> <p><b>Implicit</b>—The value from the Visible State control is displayed as it is, without any external decimal position manipulation. For example, a value of "1" is displayed as "1" and a value of "1.3" is displayed as "1.3". If the number of digits following the decimal point is too large to fit in the display, the fraction is rounded off to fit the number of digits. For example, if the display has four digits, and the value is "1.237", the display shows "1.24". If an integer value or the integer portion of a number can't be displayed fully, asterisks (***) are displayed.</p> <p><b>PLC Controlled</b>—Check this box if you want the position of the decimal point to be determined by the PLC. This means that the decimal point is not in a fixed position, and the PLC controls the number of digits after the decimal point.</p> <p>Generally, use this option with integer values so the decimal point is only implied. If the value is an integer value, the decimal point is displayed within the number string.</p> <p>If the Visible State value is a fractional number and has fewer than the specified number of digits, the value is padded with zeros. If the value has more than the number of digits, the value is rounded off.</p> <p>If you check this button, define the Decimal Point Position control.</p> <p><b>Fixed Position</b>—Check this box if you want the decimal point to always appear in a certain position. Specify the number of digits to appear after the decimal point. Enter a value between 0 and 15. The maximum number you can enter is the Number of Digits (above) less 1.</p> <p><b>Tip:</b> Use Fixed Position with a tag that has scale and offset defined to achieve the version 5.10 Scaled Numeric Data Display capability, or define an expression to achieve the same effect.</p>
Digits after Decimal Point	<p>If you specify the decimal point as Fixed Position, enter the number of digits that will appear after the decimal point, up to 15. The maximum is the Number of Digits (above) less 1.</p>

# Allen-Bradley PLCs

Field	Meaning
Control	<p>The Numeric Data Display Object List uses the following controls. You can assign tags or expressions to these controls.</p> <p><b>Decimal Point Position</b> determines the position of the decimal point. Define this control if you specified the Decimal Display field as PLC Controlled.</p> <p><b>Polarity</b> determines whether or not a minus sign is displayed. If the Polarity control's value is other than 0, the minus sign is always displayed; if it is 0, the sign is never displayed. If this control is assigned, it overrides the Visible State value's polarity. Remember to account for the minus sign in the Number of Digits you assign.</p> <p><b>Visible State</b> controls allow you to attach an individual control to each visible state in the list.</p> <p><b>Important:</b> If you assign the Polarity control, when you create the Visible State controls use digital or analog tags with any of the following unsigned data types: byte, binary, bit position, or 1 to 8 BCD. If you use a signed data type, do not assign the Polarity control unless you want to override the values' own polarity.</p>

You can adjust the size of the Numeric Data Display Object List and format its foreground color, background color, font style, border style, and blink and underline attributes. You cannot use the Extra Large Font for the Numeric Data Display Object List. For details on formatting objects see “Changing Object Appearance,” in Chapter 9, *Creating Objects*, in the *PanelBuilder 1400e Configuration Software for Windows User Manual*.

After you configure the Numeric Data Display Object List and any other object lists that are part of the same Scrolling List, group the object lists with the Cursor List. You must group all the components of the Scrolling List at the same time or PanelBuilder will report a validation error. For more information about grouping objects see Chapter 9, *Creating Objects*, in the *PanelBuilder 1400e Configuration Software for Windows User Manual*.

For an example of how to configure Numeric Data Display Object Lists that would be displayed with your Cursor List, see “Scrolling List Example” at the end of this chapter.

## Scrolling List Example

In this example you create a Scrolling List in a keypad terminal that allows you to monitor an automobile luxury-option assembly operation. This example is part of the demonstration files that are provided with the PanelBuilder 1200 and 1400e software.

The Scrolling List object allows you to control a sequential assembly operation with up to 999 individual steps. This example demonstrates an assembly operation of 57 sequential station operations.

The Scrolling List object allows you to scroll through all 57 assembly stations, five at a time. The table below lists the 57 luxury option stations.

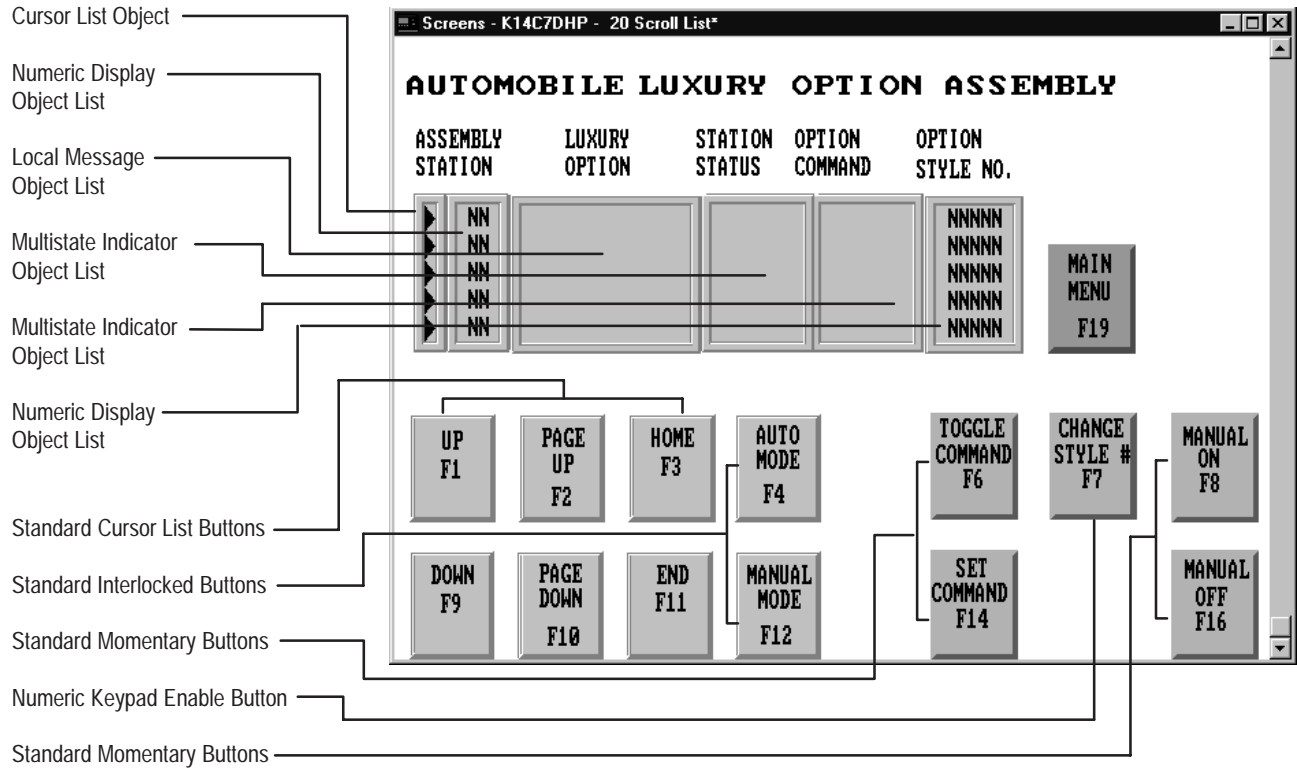
1. AM/FM Radio	20. Mahogany Dash	39. Deluxe Mud Flaps
2. Cassette Player	21. Tilt Wheel	40. Front Spoiler
3. CD Player	22. Leather Seats	41. Rear Spoiler
4. Sound Equalizer	23. Split Seats	42. Cruise Control
5. Speakers Plus	24. Bucket Seats	43. Air Ride
6. Power Antenna	25. Mileage Computer	44. Gold Trim
7. CB	26. Pin Striping	45. Door Guards
8. Phone	27. Sports Gauge	46. Password Locks
9. Television	28. Window Speed	47. White Walls
10. Power Windows	29. Voice Computer	48. Wire Wheels
11. Power Locks	30. Glove Bar	49. Mags
12. Power Seat Driver	31. Rear Window Defrost	50. Air Scoop
13. Power Seat Passenger	32. Scotch Guard	51. Turbo Plus
14. Tint Glass	33. Sound Proofing	52. Security Plus
15. Vanity Mirror	34. Headlight Retract	53. Sun Roof
16. Vanity Lights	35. Headlight Washer	54. Party Trunk
17. Cup Caddy	36. Fog Lights	55. Luggage Rack
18. Tape Storage	37. Deer Alert	56. Trailer Package
19. Wet Bar	38. Bumper Guards	57. Search Light

Creating a Scrolling List with some additional button objects allows you to monitor and control the entire operation, using either manual or automatic modes. To build the Scrolling List, you must first create a cursor list. Then you will create three different types of object lists:

- Multistate Indicator Object Lists
- Numeric Data Display Object Lists
- Local Message Object List

# Allen-Bradley PLCs

The following illustration shows how the screen for the Automobile Luxury-Option Assembly Scrolling List will appear in a keypad terminal when you have finished it.



### Step 1: Create the Cursor List

As the figure shows, the cursor list includes the cursor and the standard cursor list buttons.

When you define the cursor list, you also need to define the main scrolling list parameters. How you define these determines the size of the scrolling list, and how the cursor and buttons function with the object lists.

For this example, use the parameters and addresses shown in the following two tables:

Scrolling List Object Parameters	Quantity
Number of States	57
Number of Visible States	5
Number of Preview States	1

Cursor List Object Addresses	Block Transfer Address	Number of Bits	PLC Address
Cursor Control Address	BO50	16	N30:10
Cursor Indicator Address	BI50	16	N30:1
Top Position Address	BI51	16	N30:2
Enter Key Control Address	Not used		
Enter Key Handshake Address	Not used		

After you have defined the Cursor List object addresses, you are ready to begin creating the object lists.

## Step 2: Create the Object Lists

To monitor and control all the stations of the Automobile Luxury-Options Assembly, create these five object lists:

- two Numeric Data Display Object Lists
- two Multistate Indicator Object Lists
- one Local Message Object List

In this application, each object list serves a different function. These functions are outlined below.

### Assembly Stations

A Numeric Display Object List displays the station number of the automobile assembly sequence. The station numbers range from 1 to 57. Because five visible states are configured, five stations are always visible. The values displayed depend on where the cursor moves and the number of preview states selected.

### Luxury Option

The Local Message List contains the luxury option descriptions for each station from 1 to 57. The Local Message Object List for the Scrolling List object displays the appropriate luxury option description for each of the five stations currently visible based on the cursor position.

# Allen-Bradley PLCs

### Station Status

A Multistate Indicator Object List displays the status of each of the five visible stations. The following table shows the eight different states that are possible for each station, and the PLC value.

State	Message	PLC Value
0		0
1	Stand-by	1
2	On	2
3	Complete	3
4	Bypassed	4
5	Manual On	5
6	Manual Off	6
7	Alarm	7

### Option Command

A Multistate Indicator Object List displays command state text for each of the five currently visible stations.

State	Message	PLC Value
0		0
1	Select	1
2	Bypass	2
3	Manual On	3
4	Manual Off	4

In this example you can use a momentary button identified as TOGGLE COMMAND to toggle and display between “Select” and “Bypass” for the station currently selected by the cursor. Another momentary button, labeled SET COMMAND, activates the toggled command.

You can also modify the command for the station currently selected by pressing the standard momentary buttons “Manual On” or “Manual Off”. The PLC uses the Cursor Indicator Address to change the selected station’s command.



### Option Style Number

A Numeric Display Object List displays the style numbers of the currently visible stations. The values displayed in this list also depend on cursor movement.

The Numeric Keypad Enable Button allows you to modify the style number of the selected luxury option station in manual mode.

### Assigning Addresses for Object Lists

These tables list the addresses and files used in the example PLC program for each of the object lists.

The following table displays the addresses for each of the object lists:

Object List	Visible State BLK Transfer Start Address	Number of Contiguous Addresses	Number of Bits per Address	Visible State PLC Start Address
ASSEMBLY STATION Numeric Display	BO51	5	16	N30:11
LUXURY OPTION Local Message	BO56	5	16	N30:16
STATION STATUS Multistate Indicator	BO511	5	16	N30:21
OPTION COMMAND Multistate Indicator	BO516	5	16	N30:26
OPTION STYLE NO. Numeric Display	BO521	5	16	N30:31

# Allen-Bradley PLCs

The following table displays the addresses for each of the additional buttons:

Additional Buttons	Command BLK Transfer Address	Indicator State BLK Transfer Address	PLC Address
AUTO MODE	BI52/1 (Value = 1)		N30:3/1 (Value = 1)
MANUAL MODE	BI52/1 (Value = 0)		N30:3/1 (Value = 0)
TOGGLE COMMAND	BI52/3		N30:3/3
		BI52/1	N30:3/1
SET COMMAND	BI52/0		N30:3/0
		BI52/1	N30:3/1
MANUAL ON	BI52/4		N30:3/4
		BI52/1	N30:3/1
MANUAL OFF	BI52/5		N30:3/5
		BI52/1	N30:3/1
NUMERIC KEYPAD ENTER KEY FOR STYLE NUMBER	BI52/6		N30:3/6
CHANGE STYLE NO. CONTROL ADDR	BI53/0 — 3/15		N30:4

The following table displays the addresses for the Object List PLC files:

Object List PLC Files	PLC File Addresses	PLC File Data Presets
ASSEMBLY STATION	N31:1 through N31:57	1 through 57
LUXURY OPTION	N32:1 through N32:57	1 through 57
STATION STATUS	N33:1 through N33:57	1
OPTION COMMAND	N34:1 through N34:57	1
OPTION STYLE NO.	N35:1 through N35:57	100

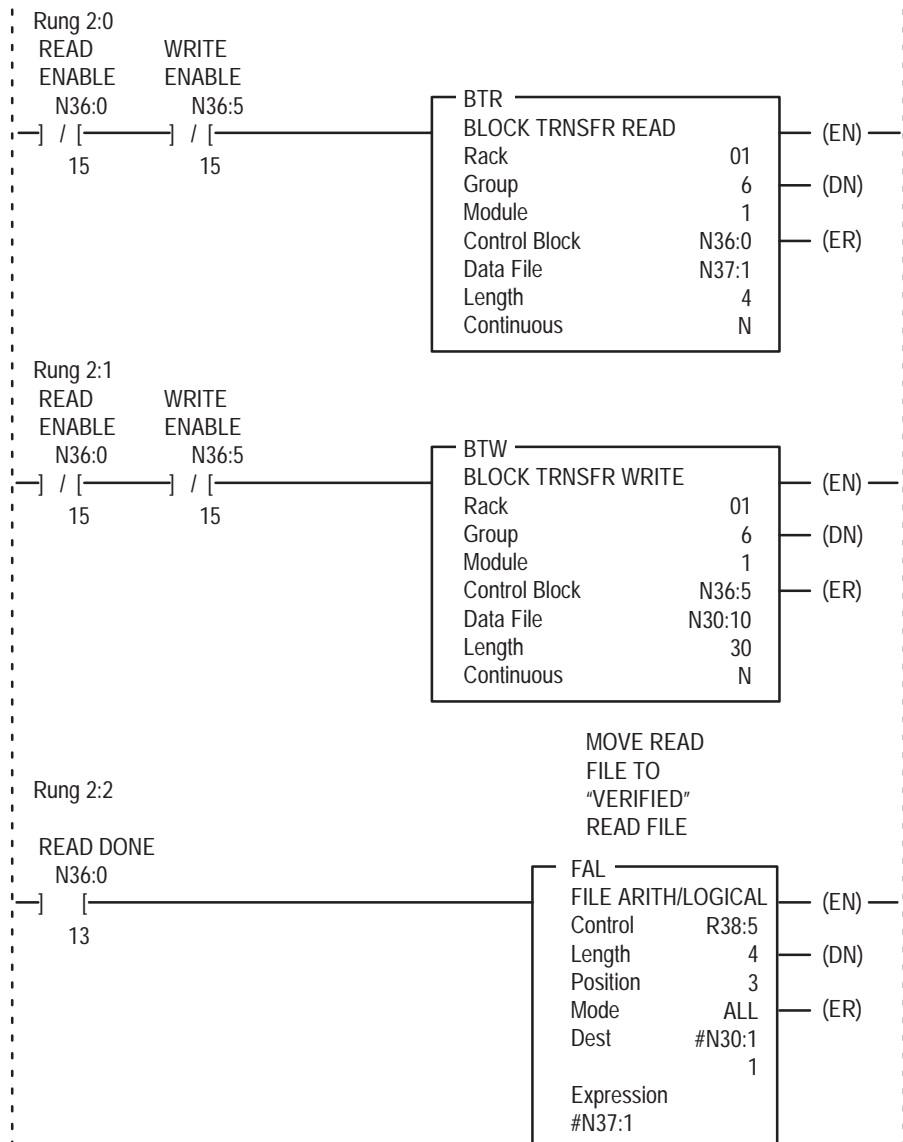
When you have assigned all the addresses for the Object List PLC files, you are ready to begin programming the PLC.

### Step 3: Program the PLC

To program the PLC, follow the ladder diagrams shown in the following pages.

### Create the Block Transfer Rungs

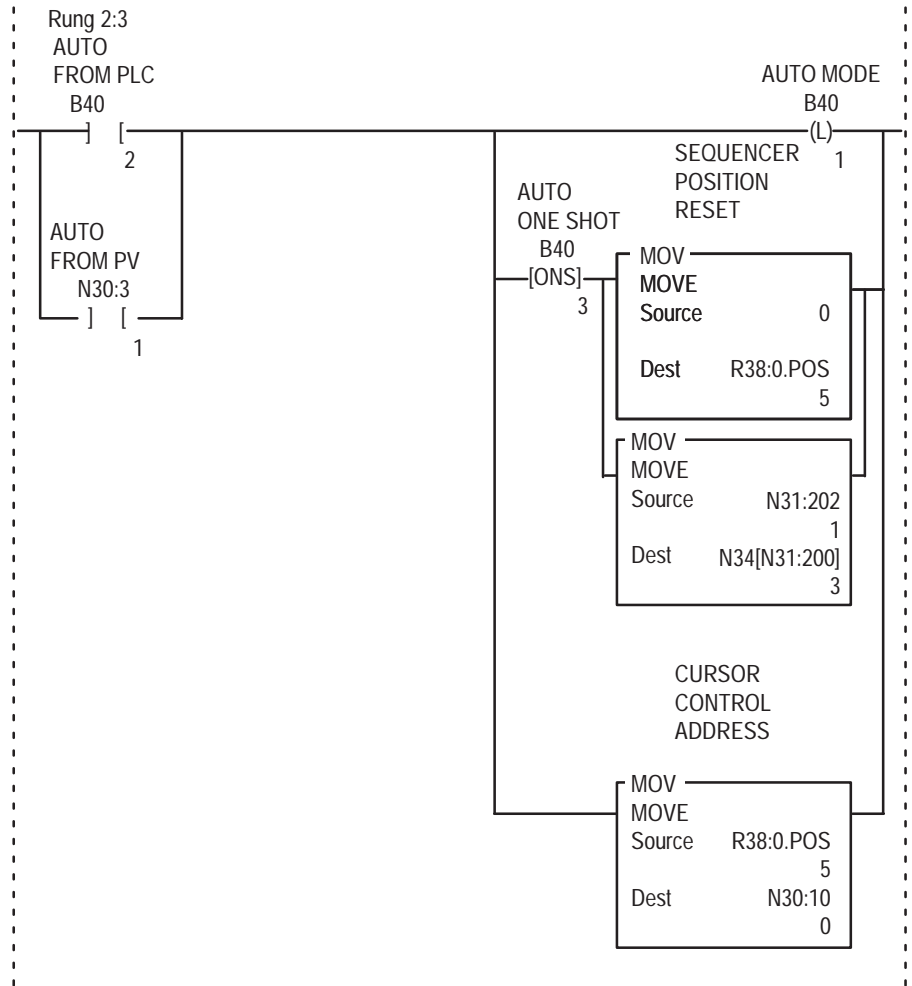
The illustration below shows the Rungs 2:0, 2:1, and 2:2. These three rungs read and write Scrolling List data to and from the PanelView terminal. This is a bi-directional block transfer. For more information about block transfers, see Chapter 2, "Planning Applications," in the *PanelBuilder 1400e Configuration Software for Windows User Manual*.



23669

### Create the Auto Mode Rung

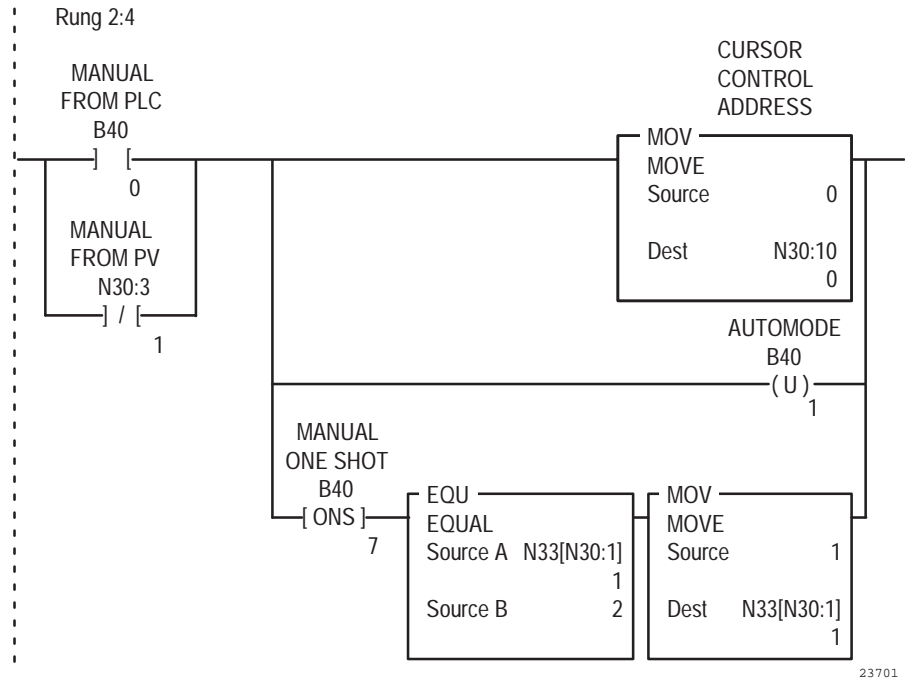
When Rung 2:3 is energized, the Auto mode bit latches and the sequencer resets to its safe state (position 0). When the sequencer increments its position above Step 0, the Scrolling List cursor is controlled by the PLC via the Sequencer Position Word Move to the Cursor Control Address, and the Manual Cursor List buttons are disabled automatically.



23700

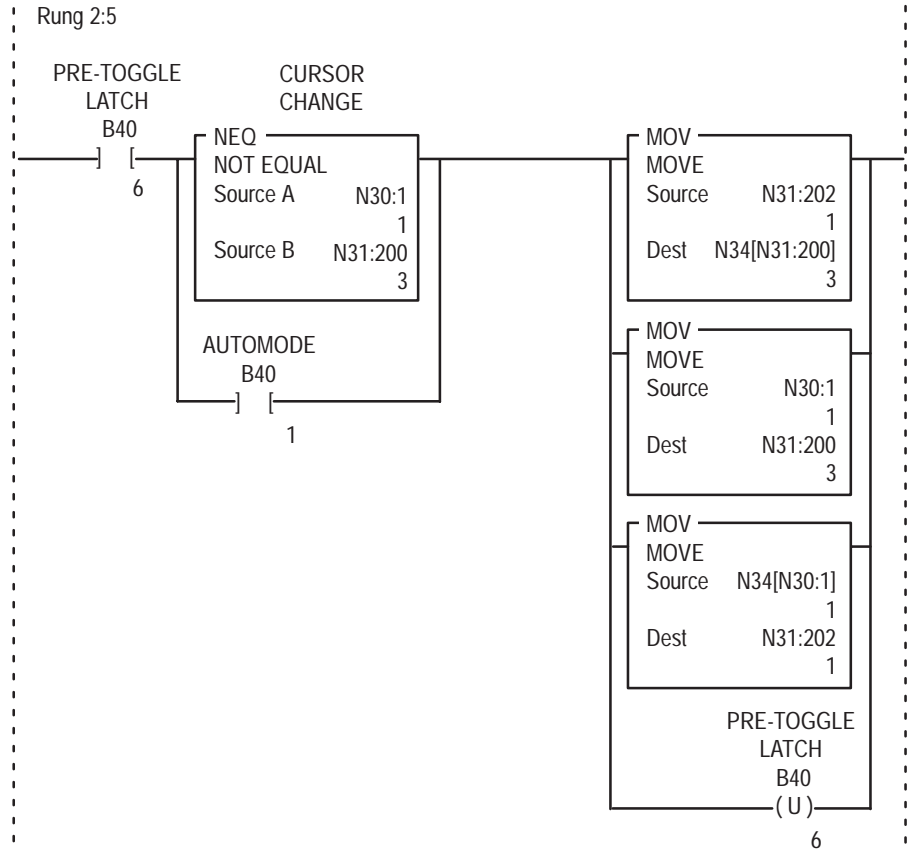
### Create the Manual Mode Rung

Rung 2:4 places the process in Manual mode. It moves a 0 to the Cursor Control Address and permits the Cursor List buttons to control the cursor. This rung also places the currently “On” station to “Stand-By” when Auto mode is switched to Manual.



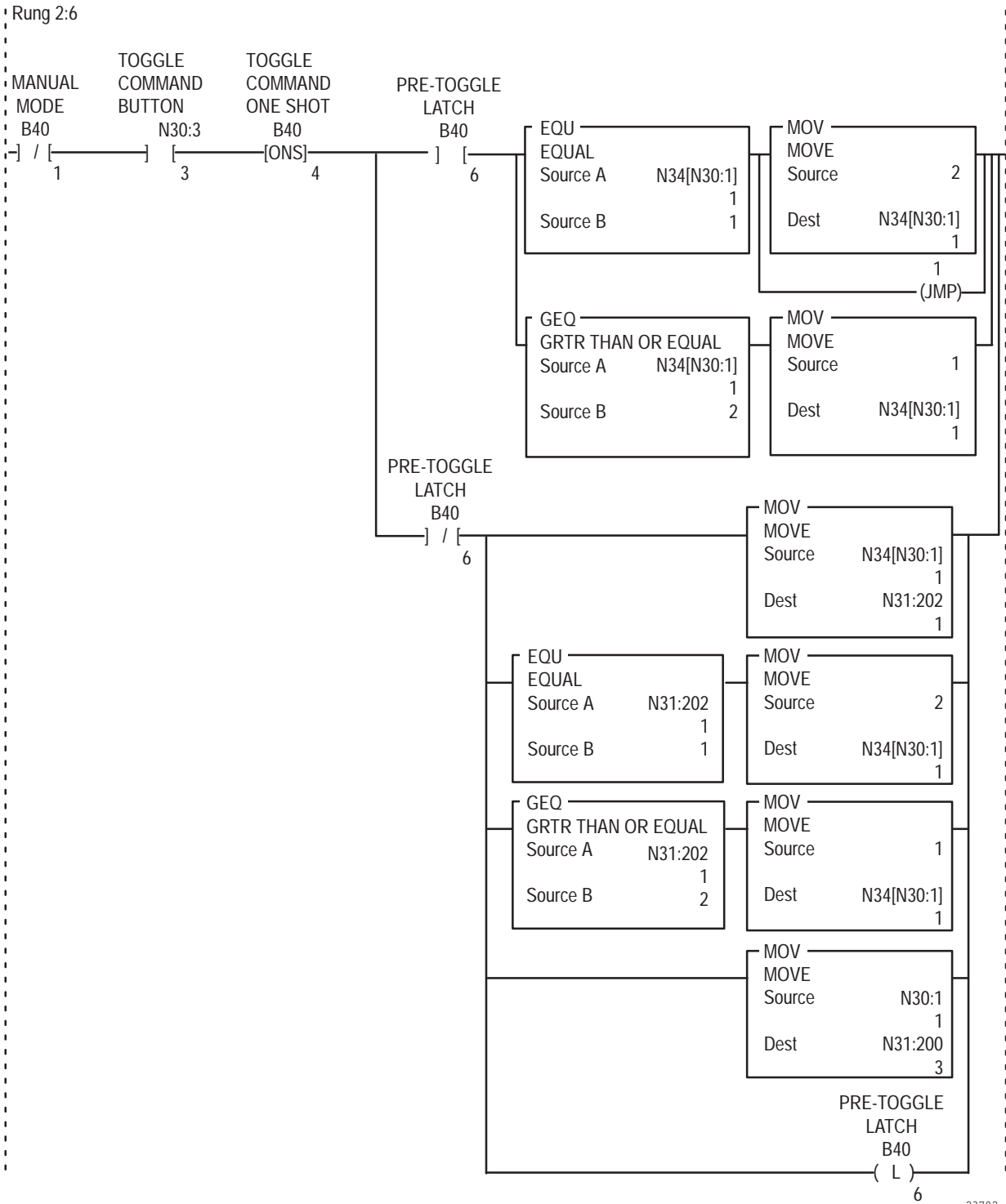
### Create the Toggle Command Rungs

Rung 2:5 handles the toggle command variables when a cursor change or mode change occurs.



23719

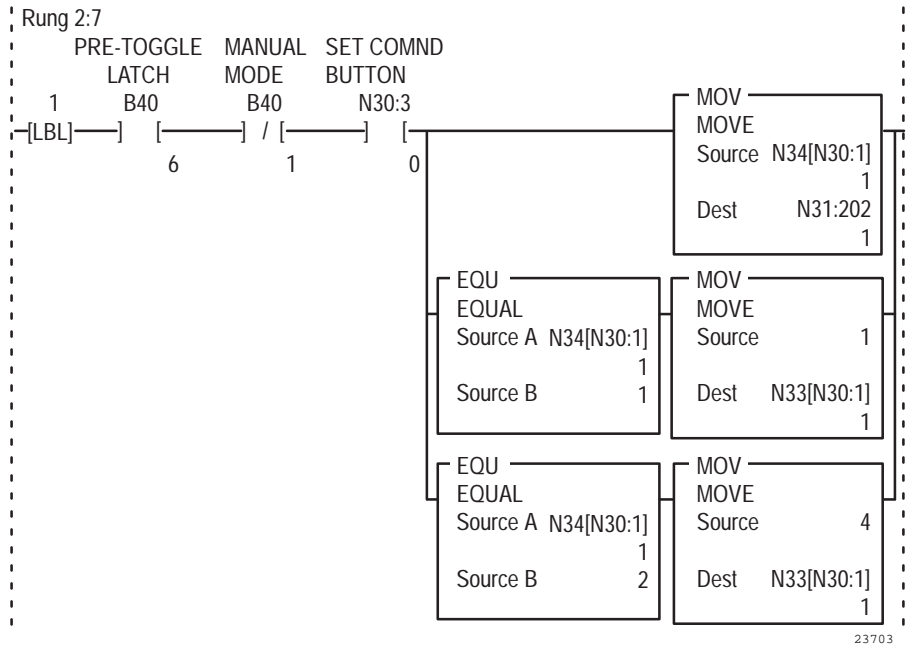
Rung 2:6 toggles the command between “Select” and “Bypass” for the currently selected station.



23702

### Create the Set Command Input Rung

Rung 2:7 enables the Set Command function. When the Set Command button is pressed, the currently displayed command value is placed in the command variable address. This secures the new command value when the cursor position or mode changes. This rung also sets the Station Status file according to which command is set.



### Create the Option Style Number Input Rung

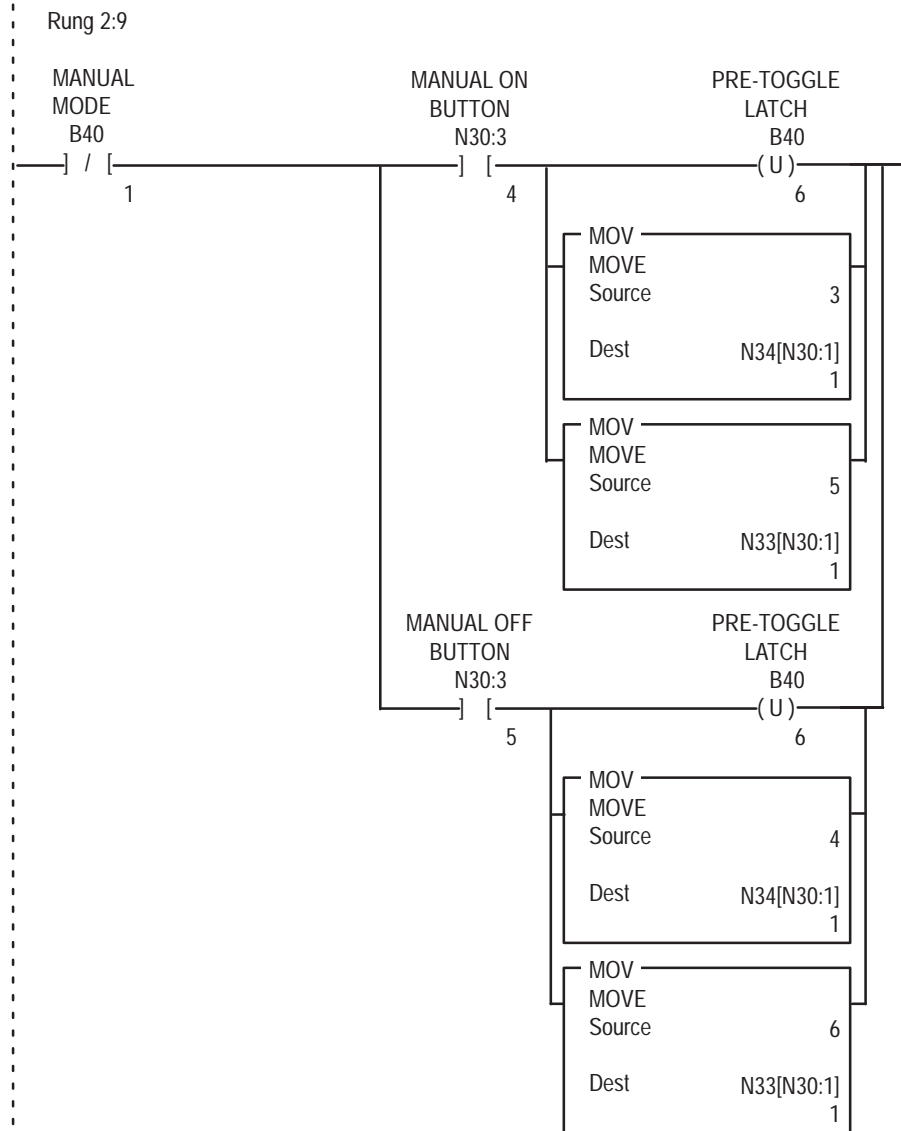
When the operation is in Manual mode and the numeric keypad enable object Enter key is pressed, Rung 2:8 transfers the new Option style number value to the currently selected station's option style address. The PLC ladder logic uses the Cursor Indicator address as its pointer.





### Create the Manual On / Manual Off Input Rung

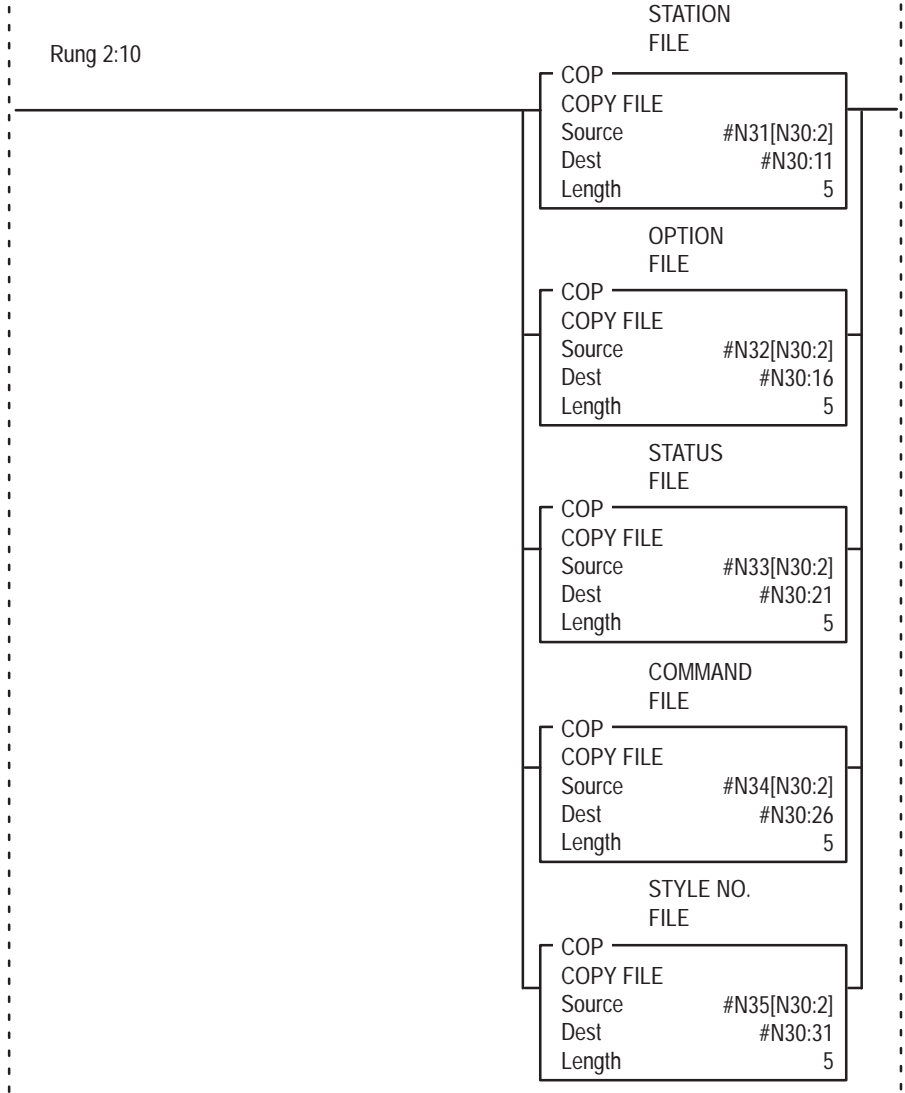
Rung 2:9 allows you to change the command value for the selected station to Manual On or Manual Off while in Manual mode. This rung uses the Cursor Indicator Address to place the command value in the proper command file (N34, word address 1 through 57). It also updates the Status File (N33) accordingly.



23705

### Create the Visible State File Copy Rung

Rung 2:10 copies appropriate file data to the visible state addresses for each object list. The data copied is based on the Top Position Address value from the PanelView terminal.

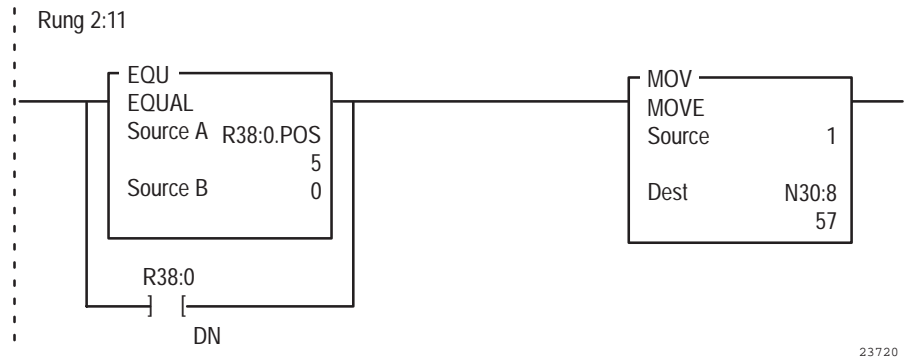


23706

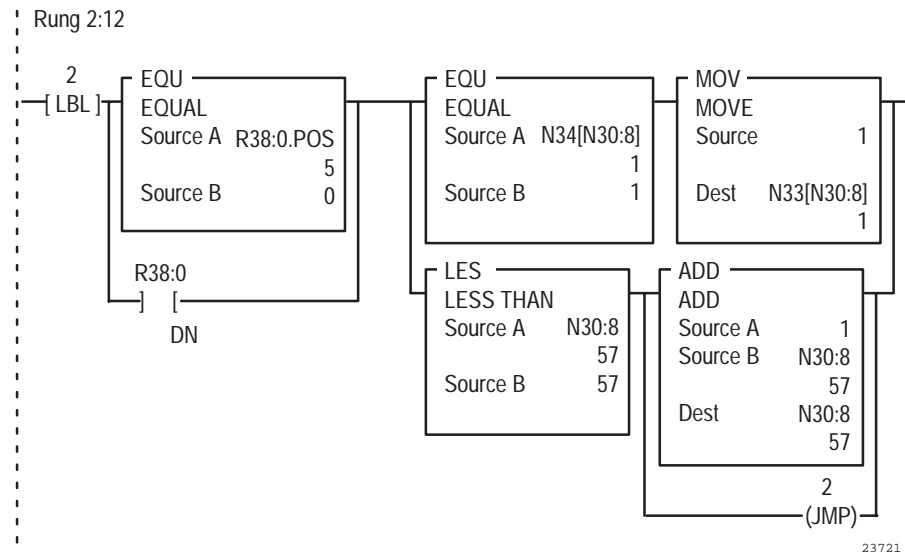
### Create the Auto Mode Simulation Rungs

Rungs 2:11 through 2:14 simulate a sequential process. This is for example purposes only.

Rung 2:11 sets a variable N30:8 to 1 when an Auto mode restart occurs. This sets up a station status reset in the next rung.



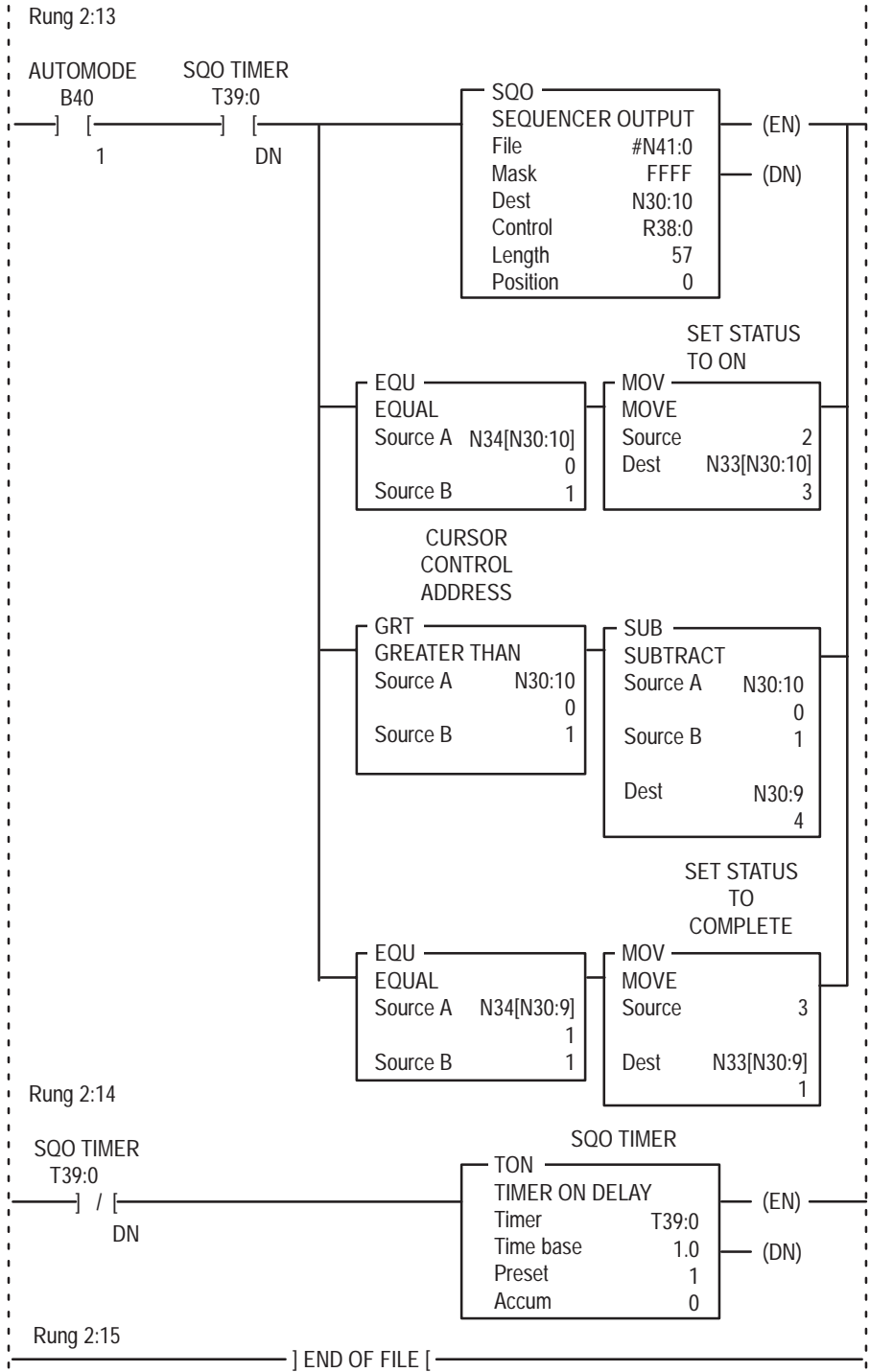
Rung 2:12 resets all STATION status indicators to “Stand-By” whose Station Commands are “Select”.



Rung 2:13 includes the Simulation Sequencer driven by the timer in rung 2:14. Rung 2:13 also sets the currently selected station status to “On”, and the previous station status to “Complete” as the sequencer increments through the 57 steps.

Rung 2:14 includes the timer that increments the simulation sequencer each second.

# Allen-Bradley PLCs



23707

## Symbols

This chapter tells you about:

- what Symbols are
- available labels for Symbols
- how to configure Symbols

### About Symbols



Symbols are identical in function to Multistate Indicators, except that the same graphic image label appears for every state. Symbols use less memory than Multistate Indicators, and the PanelView terminal processes information more quickly for Symbols. You can include any number of Symbols in your screen.

A Symbol can have up to 255 different states. You can assign unique attributes such as color and blink to every state, but the monochrome graphic image you assign to it is used for all states. You assign a Symbol State control to the Symbol object. The value of this control determines the state that is displayed at runtime.

If a value that has not been assigned to any of the states is written to the control, or if no control is defined, an error state occurs and the highest numbered state is displayed without the image. This will cause the Symbol to disappear.

### Available Graphic Images

Your PanelBuilder 1400e install set includes a set of 32 standard ISA Industrial Symbol bitmaps in two sizes. These are monochrome bitmaps you can use as Symbols. If you followed the default installation, the bitmaps will be in PanelBuilder 1400e's \IMAGES\ISA directory. Appendix A, *ISA Symbols*, shows the ISA symbols available.

There is also a set of monochrome DIN symbols in the \IMAGES\DIN directory. Appendix B, *DIN Symbols*, shows the DIN symbols available. The IMAGES\ARROWS and IMAGES\PARTS directories contain sets of arrows and equipment parts, respectively. They are listed in Appendix C, *Arrows and Parts*. Some of the arrows are monochrome and can be used as symbols. The equipment parts cannot be used as Symbols because they are not monochrome.



**Note:** You can use any monochrome bitmap for a Symbol, including bitmaps you import from another application. You cannot use .dxf images for Symbols.

- ▶ **Tip:** To use .dxf images as Symbols, export them. The .dxf images are exported as bitmap (.bmp) images, and you can use any bitmap image for a Symbol. Ensure that the size of the .dxf image is correct before you export it as a bitmap image, because bitmap images do not resize well.

## Sizing Symbols

You can increase or decrease the size of the symbols once you place them on screens in PanelBuilder. You can use multiple copies of the same symbol and change the size of any or all of them. The size of the source graphic image remains unchanged; PanelBuilder saves each new size of the symbol as a separate graphic when the application's .pvd file is created.

- ▶ **Note:** The application's size increases each time you resize a symbol. Limit the number of symbols you resize to ensure that your application will fit in the terminal's memory.

## Configuring Symbols

For information about placing Symbols on the screen, refer to Chapter 9, *Creating Objects*, in the *PanelBuilder 1400e Configuration Software for Windows User Manual*. Configure each Symbol according to this table:

Field	Meaning
Name	Assign a name, up to 15 characters, to document the object for printed reports. This increases the application's size by 1 byte per character.
Number of States	Assign the number of states you want the Symbol to have. The maximum number you can assign is 255.
Edit States	Change the value of each state. To do so, choose Edit States. You can assign any unique value from -2,147,483,648 to 2,147,483,647. For more information about changing state values, see "Configuring Object States," in Chapter 9, <i>Creating Objects</i> , in the <i>PanelBuilder 1400e Configuration Software for Windows User Manual</i> .  <b>Note:</b> To minimize the size of the application file, use state values that increment by one for each state. Do not configure more states than you need.

---

Field	Meaning
Select Graphic Image	To change the bitmap, choose Select Graphic Image from the Configure Symbol dialog box. The Select Symbol dialog box appears, with all the graphic image library's bitmaps listed. Choose the graphic image you want to use, or import it. You can select monochrome bitmaps only.
Control	<b>Symbol State</b> determines which state is shown. You can assign a tag or expression to this control. <b>Important:</b> If a value that has not been assigned to any of the states is written to the control, or if no control is defined, an error state occurs and the highest numbered state is displayed without the image. This will cause the Symbol object to disappear.

---

You can format the Symbol's foreground color, background color, border style, fill style, and blink attributes. The fill and border style you assign apply to every state, but you can configure individual colors and blink attributes for each state. For details on formatting objects see "Changing Object Appearance," in Chapter 9, *Creating Objects*, in the *PanelBuilder 1400e Configuration Software for Windows User Manual*.

---

## Text

This chapter tells you about text.

- ▶ **Tip:** To simplify screen editing and maximize runtime performance, convert all text and drawing objects into wallpaper. See Chapter 9, *Creating Objects*, in the *PanelBuilder 1400e Configuration Software for Windows User Manual*, for detailed information.

### About Text



Text is used for describing screens, objects, functions, and so on. You can add text to the screen background, or add it to an object as an object label.

A text label is part of an object. For example, you can add text labels to a List Indicator or to a button to provide information to the operator. If you configure an object to change appearances for different states, you can also have different text labels appear for each state.

You can format the foreground color, background color, font style, and blink and underline attributes of the text.

- ▶ **Note:** If you use the Extra Large Font for your text, the application will be compatible only with PanelView Version 2 or later. The application will not be compatible with earlier versions.

For step-by-step instructions about creating and editing text and text labels, see Chapter 9, *Creating Objects*, in the *PanelBuilder 1400e Configuration Software for Windows User Manual*.

### The Extended ASCII Character Set

For a list of the ASCII character set, see Appendix D, ASCII Character Set, in this manual. You can also use PanelBuilder 1400e to create characters not found on your keyboard by pressing ALT and typing a number on the numeric keypad. See Appendix B, *The Extended Character Set*, in the *PanelBuilder 1400e Configuration Software for Windows User Manual* or refer to the online help.



# Time and Date Displays

This chapter tells you:

- about Time and Date Displays
- how to configure Time and Date Displays

## About Time and Date Displays

Use the Time Display and the Date Display to show time and date information on your application.



### Time Display

The Time Display shows the current time at a specified location on a screen.

Use the PanelView terminal's Configuration Menu or the PLC Controlled Time & Date option in the PLC I/O Control Options dialog box (see Chapter 12, *Configuring Terminal and PLC Options*, in the *PanelBuilder 1400e Configuration Software for Windows User Manual*) to set the correct time on your PanelView terminal. Use the terminal's Configuration Menu to configure the time display format.



**Note:** Only one time or date object will run per screen.



### Date Display

The Date Display shows the current date at a specified location on a screen.

Use the PanelView terminal's Configuration Menu or the PLC Controlled Time & Date option in the PLC I/O Control Options dialog box (see Chapter 12, *Configuring Terminal and PLC Options*, in the *PanelBuilder 1400e Configuration Software for Windows User Manual*) to set the correct date on your PanelView terminal. Use the PanelView terminal's Configuration menu to configure the date display format.



**Note:** To display the full year (four digits) on the PanelView terminal, make the object large enough for the full format. If the field is not large enough, the full year will not be displayed.

## Configuring the Time and Date Display

Configure the Time and Date Display according to the following table:

Field	Meaning
Name	Assign a name, up to 15 characters, to document the object for printed reports. This increases the application's size by 1 byte per character.
Display Type	Specify Time Display or Date Display.

You can adjust the size of the Time or Date Display and format its foreground color, background color, font style, border style, and blink and underline attributes. For details on formatting objects see “Changing Object Appearance,” in Chapter 9, *Creating Objects*, in the *PanelBuilder 1400e Configuration Software for Windows User Manual*.



**Note:** If you use the Extra Large Font, the application will be compatible only with PanelView Version 2 or later. The application will not be compatible with earlier versions.

## Trends

This chapter tells you about:

- how Trends function
- how to configure Trends

### About Trends

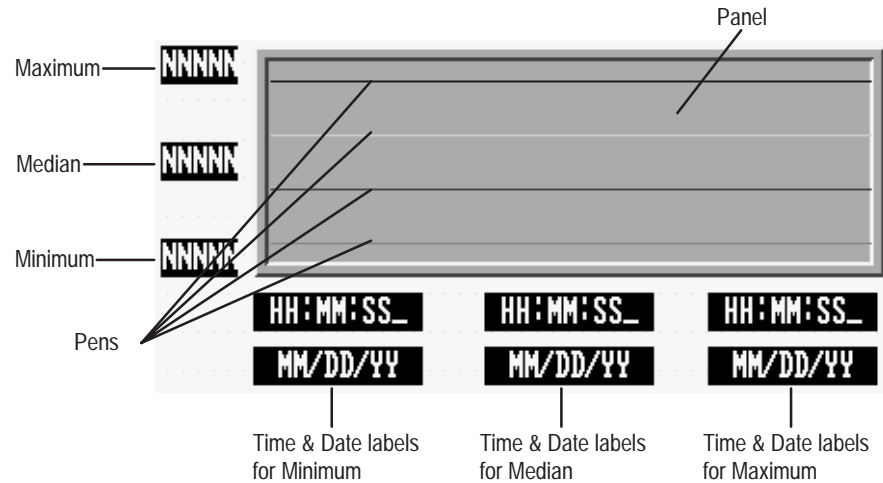
Trends allow the operator to track process variables over a period of time. The Trend is a dynamic, graphical display object with time on the horizontal axis and the value range of the process variable on the vertical axis. For example, you can use Trends for Proportional Integral Differential (PID) loop tuning or for data analysis.



**Note:** If you use the Trend object the application will be compatible with PanelView Version 2 or later. It will not be compatible with earlier versions.

You can use up to four Trend objects per screen. The Trend object consists of a panel, up to four pens, value indicators for maximum, median and minimum, and time and date displays for the maximum, median and minimum values. Time is displayed on the horizontal axis; values are displayed on the vertical axis. You cannot change this orientation of the Trend object.

The Trend uses a pen to plot each variable. You can use up to four pens per Trend object to track up to four process variables. The values plotted on a Trend object are called data points. The number of data points is determined by the number of pens in the Trend, the sample rate, and the time span covered by the Trend. The number of data points that can be displayed on the screen is determined by the width of the Trend object. Each pen can display a maximum of 640 data points at a time on the screen. An example of a Trend object is shown below.



All pens in a Trend can be configured to plot values either in the foreground or in the background, or the individual pens in a trend can be configured (independently of the trend as a whole) for foreground or background plotting.

If one or more pens are configured to use background plotting, the Trend begins to plot values for those pens when the application enters Run mode, and continues to plot values whether or not it is displayed. The Trend does not retain data when you switch modes or select a new application. It also does not retain data across power cycles of the PanelView terminal. For pens not configured to use background screen plotting, the Trend object begins to plot values when it is displayed on the PanelView terminal. These values are not saved when you switch to a different screen.

You can configure up to 85 pens in your application for background plotting, but the total number of data points cannot exceed 3000 for all pens using background plotting. You can see the total number of data points in use for background plotting in your application in the Configure Trend Object dialog box, when you enable the background screen for one or more pens.

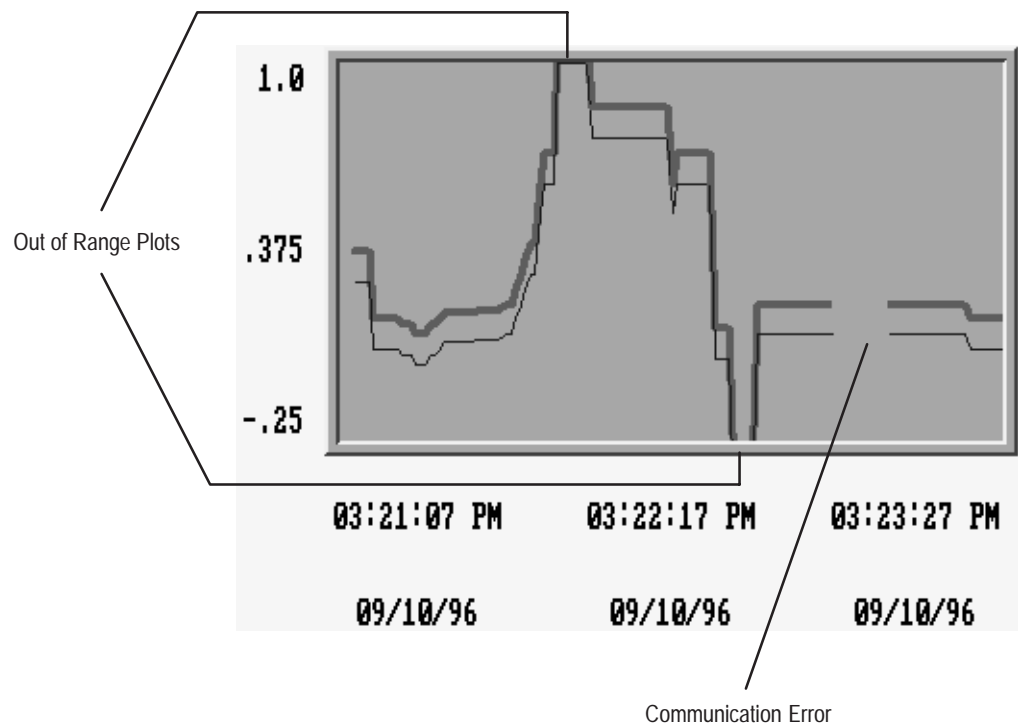
The Trend plots from the right side, scrolling to the left to make room for a new data point each time a new point is plotted. The time labels on the horizontal axis, if used, are updated every time a data point is collected.

The Trend object includes Trend Minimum Value and Trend Maximum Value controls to specify the range of values to display at a given point in time. The Minimum and Maximum values allow the Trend to zoom in and out by adjusting the range of values displayed on the vertical axis. If you change the value for the minimum or maximum value displayed, the Trend is re-plotted at the new range of values.



**Note:** If the trend contains a large number of values, and the sample rate is fast, a few unreliable points will be generated while the trend is re-drawn. These unreliable points may cause a break in the plotted data, similar to that caused by a communication error. Existing values are not affected.

If a value is outside the range specified by the Trend Minimum and Maximum Value controls, the pen line is drawn to the lower or upper edge of the Trend object and then disappears. When a plotted value is next within the specified range, a line is drawn from the lower or upper edge of the Trend object to the new point. No data appears for the time interval during which the values are outside the specified range.

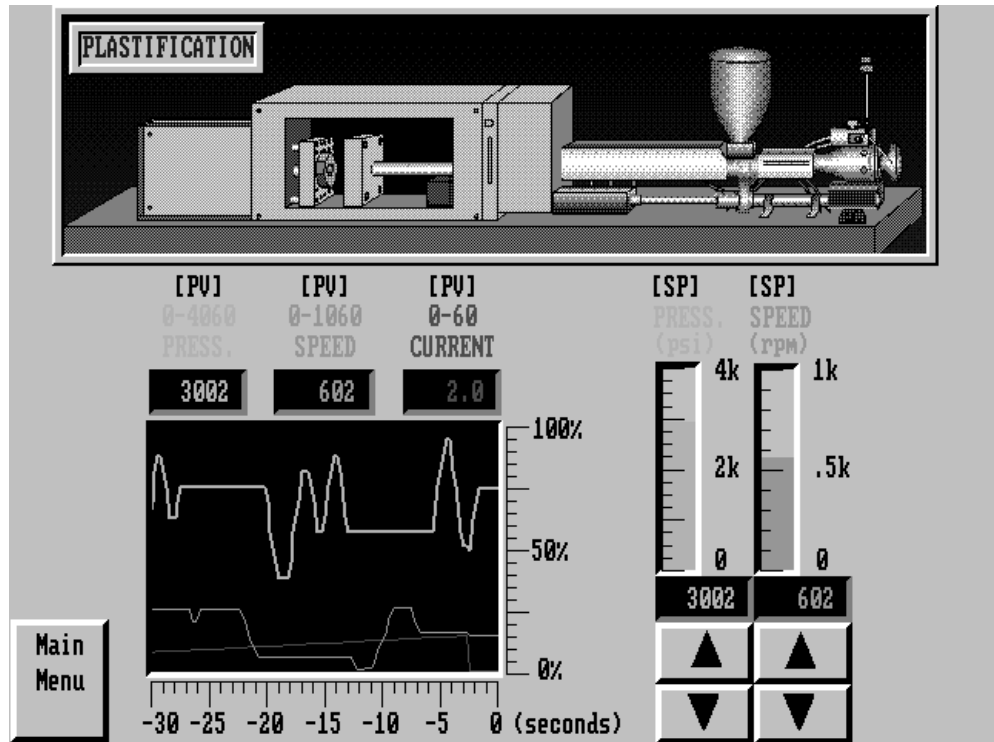


If there is an error in the value of the Trend Minimum or Maximum Value control, the Pen Value label corresponding to the control is filled with asterisks (\*\*\*). Values that have already been plotted are erased, and new data is collected, but not plotted, until the error state no longer exists. An error state also occurs when the Trend Minimum Value control value is greater than the Trend Maximum Value control value, and when there is an overflow or underflow in the value of either control.

If a communication error occurs, there is a break in the plotted data until communication is resumed. New values are plotted beginning at the point in time when communication resumes.

# Allen-Bradley PLCs

- ▶ **Tip:** Use the Scale object to provide a scale along the axes of the Trend object, as shown in the example below. Configure the number of ticks in the Scale to correspond to the frequency with which the Trend is updated and to represent the value ranges of the activity you are tracking.



- ▶ **Note:** When placing the Trend object on the screen, ensure that no other objects overlap it. Objects overlapping a Trend object will cause an error when the application is validated.

## Configuring the Trend

Configure the Trend according to this table:

Field	Meaning
Name	Assign a name, up to 15 characters, to document the object for printed reports. This increases the application's size by 1 byte per character.
Number of Pens	Specify the number of process variables to track, from 1 to 4. Choose Configure Pens and choose a pen to specify the pen's color, line style, and plotting symbol, and the control each pen monitors. See "Configuring the Pens" later in this chapter. <b>Note:</b> Each Pen uses the same Sample Rate, Time Span and Minimum and Maximum Values. If the Pens' controls do not contain similar values, or if you want to plot the Pens at different rates, use separate Trend objects. <b>Note:</b> You can configure up to 85 pens for background plotting (across all Trends in your application). The total number of data points for all pens using background plotting in your application cannot exceed 3000.
Background Screen Plotting for All Pens	Select the check box if you want the Trend to continue tracking process variables even when the screen containing the Trend object is not displayed. Deselect the check box if you don't need the Trend to track the processes when the screen is not displayed.  You can configure each pen to specify whether to continue tracking its process when the screen is not displayed, as described in "Configuring the Pens" later in this chapter. The individual pen configuration overrides the Background Screen Plotting for All Pens option. <b>Note:</b> You can configure up to 85 pens for background screen plotting (across all Trends in your application). The total number of data points for all pens using background plotting in your application cannot exceed 3000.
Sample Rate	Specify the rate at which to plot new values. The range is 0.25 seconds to 86400 seconds (1 day).
Time Span	<b>Days</b> — Specify the number of days covered by the Time Span on the horizontal axis, from 0 to 7. <b>Hours</b> — Specify the number of hours covered by the Time Span on the horizontal axis, from 0 to 23. <b>Minutes</b> — Specify the number of minutes covered by the Time Span on the horizontal axis, from 0 to 59. <b>Seconds</b> — Specify the number of seconds covered by the Time Span on the horizontal axis, from 0 to 59. <b>Note:</b> The total time span of a Trend must be at least 2 seconds.
Time	Specify whether to display labels for the time at which the data is collected. The Maximum time is the time of the most recent point displayed on the Trend object. The Minimum time is the Maximum time less the Time Span. The Median time is calculated at the Maximum time less half the Time Span.  The time label is displayed using the format configured at the PanelView terminal's Time and Date configuration screen.

Field	Meaning
Date	<p>Specify whether to display labels for the date at which the data is collected. The Maximum date is the date of the most recent point displayed on the Trend object. The Minimum date is the date of the earliest point displayed on the Trend object. The Median date is the date of the median point.</p> <p>The date label is displayed using the format configured at the PanelView terminal's Time and Date configuration screen.</p>
Pen Value	<p>Specify whether to display labels for the Pen values for the range of data collected. The Minimum Pen value is the value of the Trend Minimum Value control. The Median Pen value is the average of the Minimum and Maximum values. The Maximum Pen value is the value of the Trend Maximum Value control.</p> <p>Choose Configure Labels to specify the appearance of the Pen Value labels. See "Configuring the Pen Value Labels" later in this chapter.</p>
Control	<p><b>Trend Minimum Value</b> controls the minimum value of the vertical axis. Assign a tag, expression, or constant to this control.</p> <p><b>Trend Maximum Value</b> controls the maximum value of the vertical axis. Assign a tag, expression, or constant to this control.</p>

### Configuring the Pens

Configure the pens according to this table:

Field	Meaning
Background Screen Plotting	Select the check box if you want the Trend to continue plotting this Pen even when the screen containing the Trend object is not displayed. Deselect the check box if you don't need the Trend to plot this particular Pen when the screen is not displayed. This selection overrides the Background Screen Plotting for All Pens option for this pen.
Pen Color	Select the color to use for the pen's line and symbol.
Symbol	Select a symbol to display at each data point. Leave this field blank if you do not want the Trend object to display symbols for this pen.
Line Style	Select the style of line to use to connect the data points for this pen.
Control	<b>Pen Value</b> specifies the location of the values you want this pen to track. Assign a tag or expression to this control.



## Configuring the Pen Value Labels

Configure the Pen Value Labels according to this table:

Field	Meaning
Fill Left With	Choose whether the left portion of the display will be filled with zeros or blank spaces when fewer than the maximum number of digits is displayed.
Number of Digits	Specify the number of digits that can be displayed on the screen, from 1 to 16.
Decimal Display	Specify how you want decimal points to appear in the label: <b>Disabled</b> — Select this option if you don't want a decimal point displayed. If the Pen Value control contains a decimal point, it will be rounded off. <b>Implicit</b> — The Pen Value will be displayed as it is, without any external decimal position manipulation. <b>Fixed Position</b> — Specify where the decimal point is positioned in the display. See Digits after Decimal Point, next.
Digits after Decimal Point	If you specify the Decimal Display as Fixed Position, enter the number of digits that will appear after the decimal point. The maximum is 15.












You can adjust the size of the Trend panel and format its background color and border style. You can format each Trend label's foreground color, background color, font style, border style, and blink and underline attributes. For more information about configuring objects, see Chapter 9, "Creating Objects," in the *PanelBuilder 1400e Configuration Software for Windows User Manual*.


















## ISA Symbols

This appendix lists all the ISA symbols provided with PanelBuilder 1400e. If you followed the default installation, they are in the \IMAGES\ISA directory.

### Symbol Icons





You can use any monochrome image as a Symbol object, including these bitmaps of standard ISA symbols. You can also use these bitmaps as Graphic Images. Each bitmap is available in two sizes. The file name containing the 'l'—for example, 'agitatrl.bmp'—indicates the bitmap is the large size.

Symbol Name	File Names	ISA Symbol Icon
Agitator	agitatr.bmp agitatrl.bmp	
Blower	blower.bmp blowerl.bmp	
Compressor	comprsr.bmp comprsr.l.bmp	
Conveyor	conveyr.bmp conveyrl.bmp	
Cyclone Separator	cyclone.bmp cyclonel.bmp	
Distillation Tower	distowr.bmp distowrl.bmp	
Exchanger	exchngr.bmp exchngrl.bmp	
Liquid Filter	ftliqd.bmp ftliqdl.bmp	
Vacuum Filter	ftvacm.bmp ftvacml.bmp	
Furnace	furnace.bmp furnacel.bmp	
Inline Mixer	inlmixr.bmp inlmixl.bmp	

Symbol Name	File Names	ISA Symbol Icon
Motor	motor.bmp motorl.bmp	
Pressure Storage Vessel	presves.bmp presvesl.bmp	
Pump	pump.bmp pump1.bmp	
Reactor	reactor.bmp reactorl.bmp	
Rotary Feeder	rolfeed.bmp rotfeedl.bmp	
Rotary Kiln	rotkiln.bmp rotkilnl.bmp	
Screw Conveyor	scrconv.bmp scrconvl.bmp	
Storage Bin	storbin.bmp storbinl.bmp	
Turbine	turbine.bmp turbinel.bmp	
Vessel	vessel.bmp vessell.bmp	
Horizontal Valve with Actuator	vlvacth.bmp vlvacthl.bmp	
Vertical Valve with Actuator	vlvactv.bmp vlvactvl.bmp	
Butterfly Valve	vlvbfly.bmp vlvbflyl.bmp	
Check Valve	vlvchck.bmp vlvchckl.bmp	
Horizontal Valve with Manual Actuator	vlvmach.bmp vlvmachl.bmp	
Vertical Valve with Manual Actuator	vlvmacv.bmp vlvmacvl.bmp	
Relief Valve	vlvrelf.bmp vlvrelfl.bmp	

# Allen-Bradley PLCs

---

Symbol Name	File Names	ISA Symbol Icon
Horizontal Valve with Throttling Actuator	vlvthrh.bmp vlvthrhl.bmp	
Vertical Valve with Throttling Actuator	vlvthrv.bmp vlvthrvl.bmp	
Weigh Hopper	weihopr.bmp weihoprl.bmp	
Transformer	xformer.bmp xformerl.bmp	

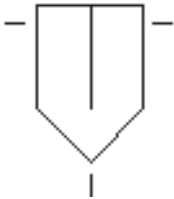
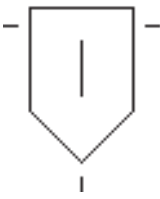
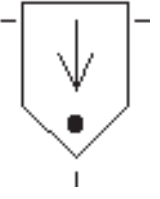
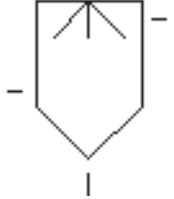
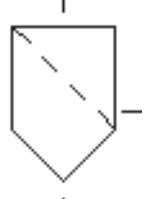
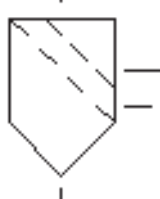
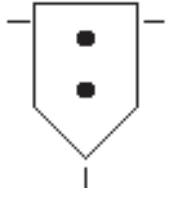
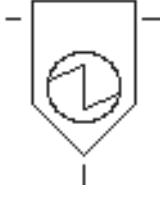
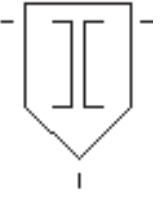
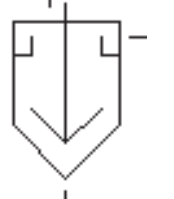

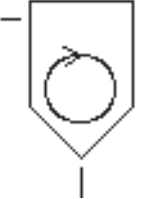
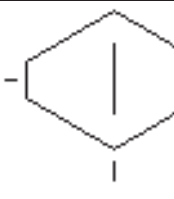
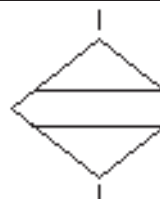
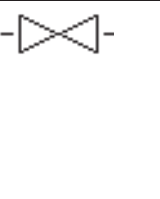
---

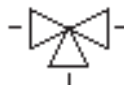






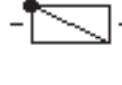

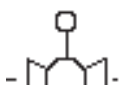
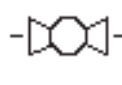
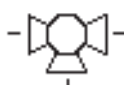
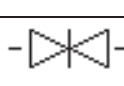
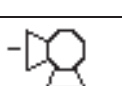
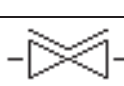
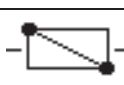



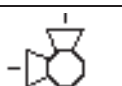
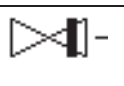
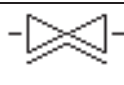
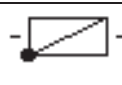
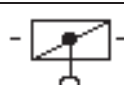





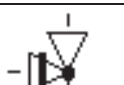
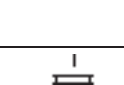
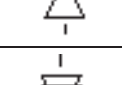
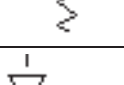


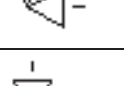
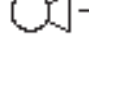
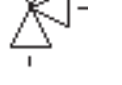


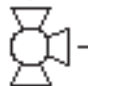

## DIN Symbols

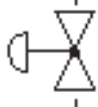
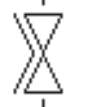


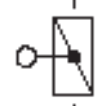
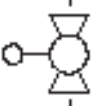



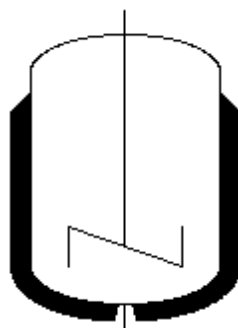
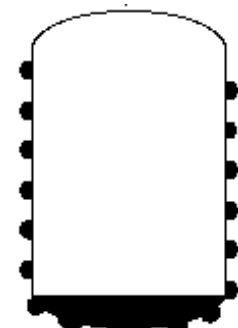
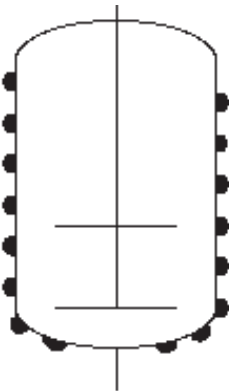
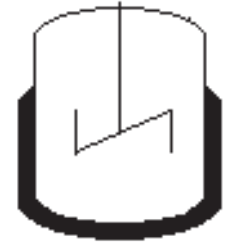
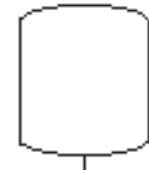

This appendix lists all the DIN symbols provided with PanelBuilder 1400e. If you followed the default installation, they are in the \IMAGES\DIN directory.

### Symbol Icons

You can use any monochrome image as a Symbol object, including these bitmaps of standard DIN symbols. You can also use these bitmaps as Graphic Images. The symbols are listed alphanumerically by file name.

File Name	DIN Symbol Icon	File Name	DIN Symbol Icon	File Name	DIN Symbol Icon
din001.bmp		din002.bmp		din003.bmp	
din004.bmp		din005.bmp		din006.bmp	
din007.bmp		din008.bmp		din009.bmp	
din010.bmp		din011.bmp		din012.bmp	
din013.bmp		din014.bmp		din015.bmp	



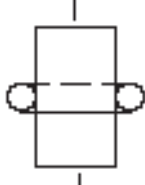
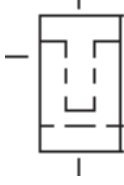
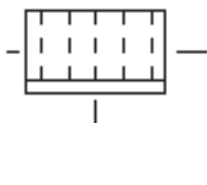
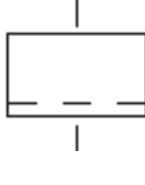
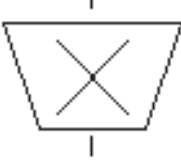
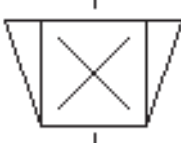
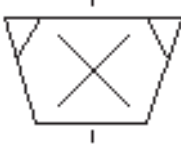
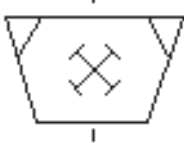
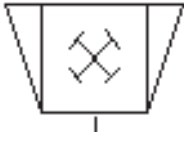
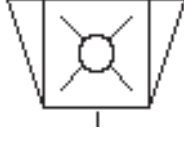
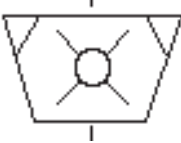
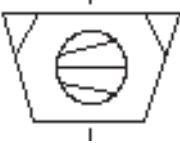
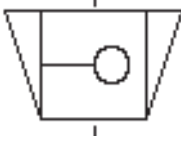
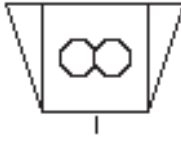

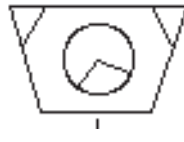
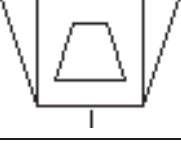


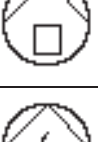
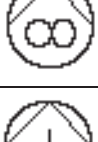
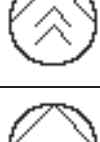

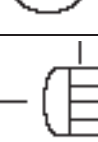
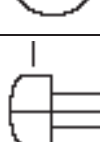


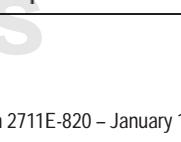
File Name	DIN Symbol Icon	File Name	DIN Symbol Icon	File Name	DIN Symbol Icon
din016.bmp		din017.bmp		din018.bmp	
din020.bmp		din021.bmp		din023.bmp	
din024.bmp		din025.bmp		din026.bmp	
din027.bmp		din028.bmp		din029.bmp	
din030.bmp		din031.bmp		din032.bmp	
din033.bmp		din034.bmp		din036.bmp	
din037.bmp		din038.bmp		din040.bmp	
din042.bmp		din050.bmp		din054.bmp	
din055.bmp		din056.bmp		din057.bmp	
din062.bmp		din078.bmp		din079.bmp	
din080.bmp		din081.bmp		din083.bmp	
din086.bmp		din087.bmp		din088.bmp	
din089.bmp		din090.bmp		din091.bmp	
din092.bmp		din093.bmp		din094.bmp	

File Name	DIN Symbol Icon	File Name	DIN Symbol Icon	File Name	DIN Symbol Icon
din095.bmp		din096.bmp		din097.bmp	
din098.bmp		din099.bmp		din100.bmp	
din101.bmp		din102.bmp		din103.bmp	
din104.bmp		din105.bmp		din106.bmp	
din107.bmp		din108.bmp		din109.bmp	

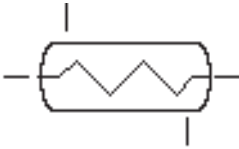
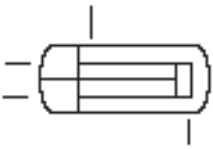
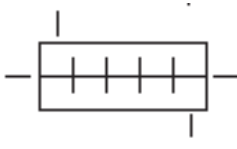
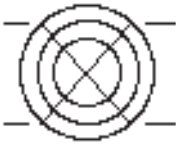
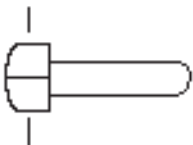
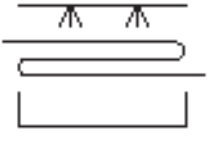
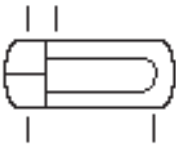
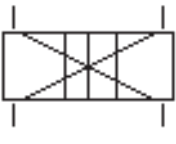











# Allen-Bradley PLCs

File Name	DIN Symbol Icon	File Name	DIN Symbol Icon	File Name	DIN Symbol Icon
din110.bmp		din111.bmp		din112.bmp	
din113.bmp		din114.bmp		din115.bmp	
din116.bmp		din117.bmp		din118.bmp	
din119.bmp		din120.bmp		din121.bmp	
din122.bmp		din123.bmp		din124.bmp	
din125.bmp		din126.bmp		din127.bmp	



File Name	DIN Symbol Icon	File Name	DIN Symbol Icon	File Name	DIN Symbol Icon
din128.bmp		din129.bmp		din130.bmp	
din131.bmp		din132.bmp		din133.bmp	
din134.bmp		din135.bmp		din136.bmp	
din137.bmp		din138.bmp		din139.bmp	
din140.bmp		din141.bmp		din142.bmp	
din143.bmp		din144.bmp		din145.bmp	
din146.bmp		din147.bmp		din148.bmp	
din149.bmp		din150.bmp		din151.bmp	
din152.bmp		din153.bmp		din154.bmp	
din155.bmp		din156.bmp		din157.bmp	

Allen-Bradley PLCs





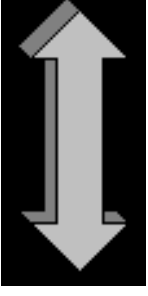








File Name	DIN Symbol Icon	File Name	DIN Symbol Icon	File Name	DIN Symbol Icon
din158.bmp		din159.bmp		din160.bmp	
din161.bmp		din162.bmp		din163.bmp	
din164.bmp		din165.bmp		din166.bmp	
din167.bmp		din169.bmp		din170.bmp	
din171.bmp		din172.bmp		din173.bmp	
din174.bmp		din175.bmp		din176.bmp	
din177.bmp					













## Arrows and Parts

This appendix lists the graphic images of arrows and equipment parts provided with PanelBuilder 1400e. If you followed the default installation, they are in the \IMAGES\ARROWS and IMAGES\PARTS directories.

### Arrows

You can use any monochrome image as a Symbol object, including some of these bitmaps of arrows (the first eight arrows are not monochrome). You can also use these bitmaps as graphic images. The images are presented alphabetically by file name in the tables that follow, to match the order in which they are listed in the Select Image and Select Symbol dialog boxes.

File Name	Arrow Shape	File Name	Arrow Shape
arrow1.bmp		arrow2.bmp	
arrow3.bmp		arrow4.bmp	
arrow5.bmp		arrow6.bmp	
arrow7.bmp		arrow8.bmp	
arrowdn.bmp		arrowdnt.bmp	
arrowlf.bmp		arrowlft.bmp	
arrowret.bmp			

File Name	Arrow Shape	File Name	Arrow Shape
arrowrt.bmp		arrowrtt.bmp	
arrowup.bmp		arrowupt.bmp	
arrwldn.bmp		arrwldnt.bmp	
arrwlp.bmp		arrwlupt.bmp	
arrwrldn.bmp		arrwrldnt.bmp	
arrwrup.bmp		arrwrupt.bmp	

## Equipment Parts

You can use these bitmaps of equipment parts as graphic images. Since they are not monochrome you cannot use them as Symbols. The images are presented alphanumerically by file name in the tables that follow, to match the order in which they are listed in the Select Image dialog box.




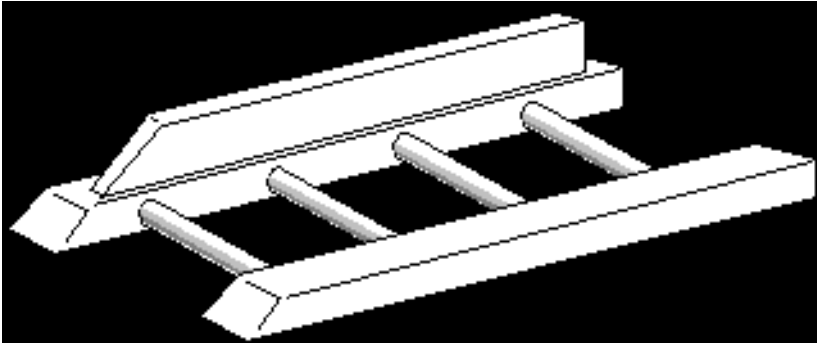
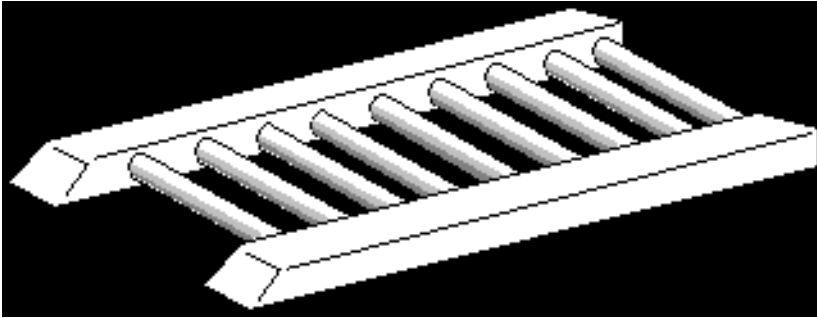
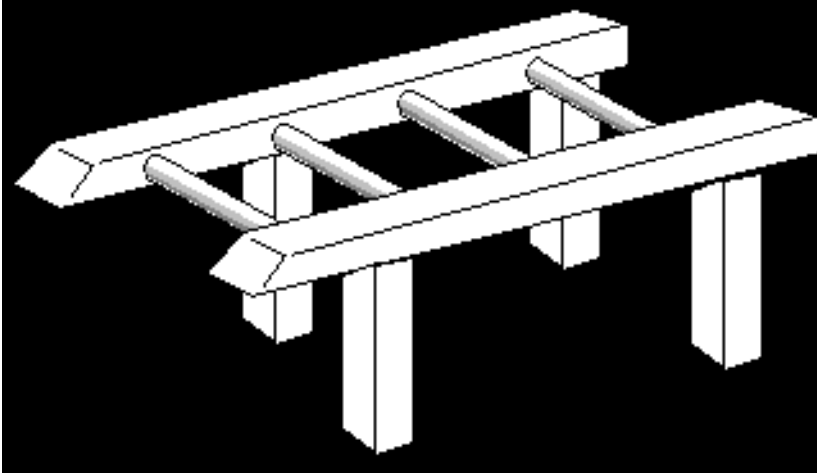

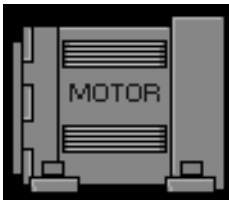
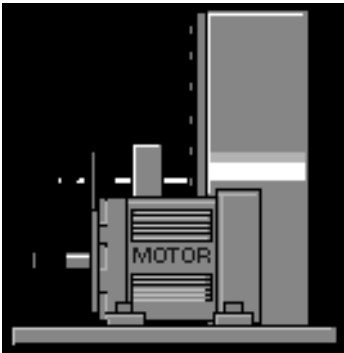
Image Type	File Name	Equipment Part Graphic Image	File Name	Equipment Part Graphic Image
Buttons	button10.bmp		button11.bmp	
	button12.bmp			

Image Type	File Name	Equipment Part Graphic Image		
Conveyors	cnv2.bmp			
	cnv3.bmp			
	cnvy1.bmp			
Image Type	File Name	Equipment Part Graphic Image	File Name	Equipment Part Graphic Image
Motors	mtr1.bmp		mtr2.bmp	

# Allen-Bradley PLCs

Image Type	File Name	Equipment Part Graphic Image
Motors	mtr3.bmp	

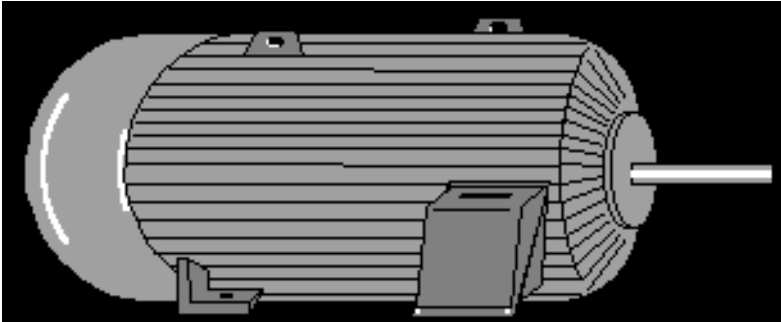
	mtr6.bmp	
--	----------	--

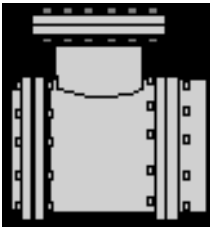



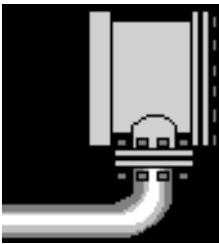








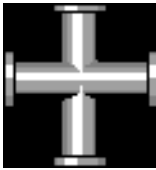




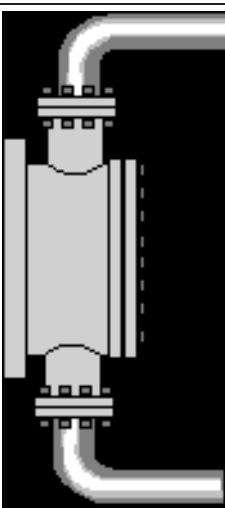
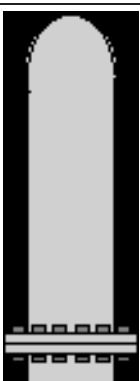
Image Type	File Name	Equipment Part Graphic Image	File Name	Equipment Part Graphic Image
Pipes	pipe1.bmp		pipe14.bmp	
	pipe15.bmp		pipe16.bmp	
	pipe2.bmp		pipe21.bmp	
	pipe22.bmp		pipe23.bmp	

Image Type	File Name	Equipment Part Graphic Image	File Name	Equipment Part Graphic Image
Pipes	pipe24.bmp		pipe25.bmp	
	pipe26.bmp		pipe27.bmp	
	pipe28.bmp		pipe29.bmp	
	pipe3.bmp		pipe34.bmp	
	pipe35.bmp		pipe4.bmp	
	pipe5.bmp		pipe6.bmp	

# Allen-Bradley PLCs

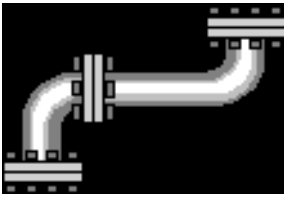





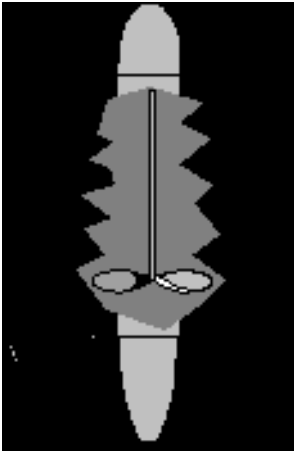


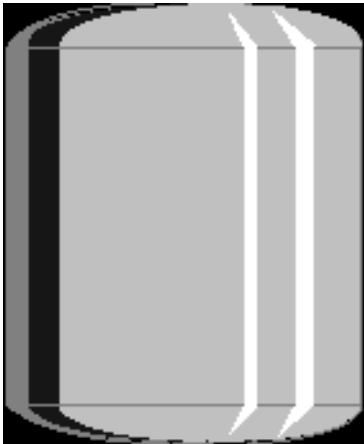

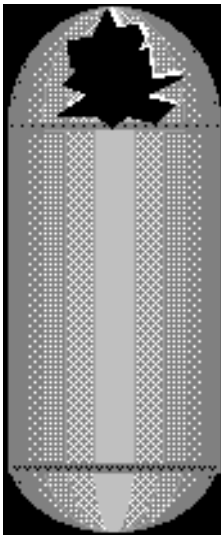
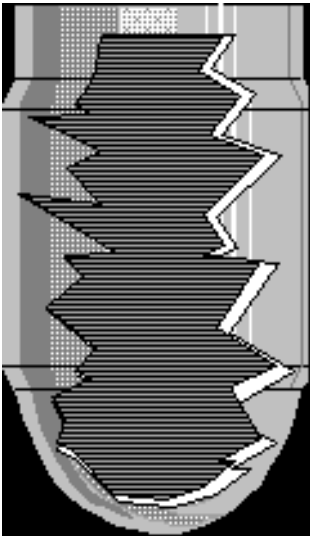
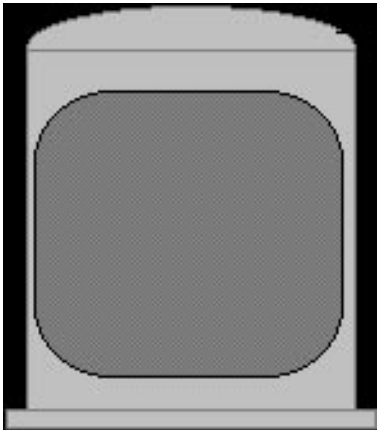
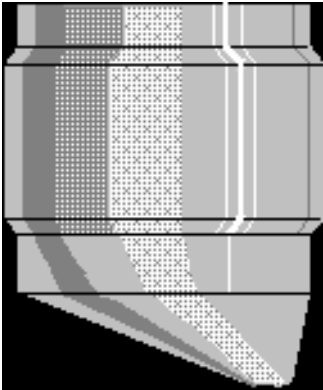
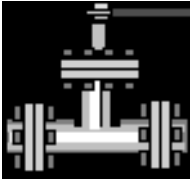

Image Type	File Name	Equipment Part Graphic Image	File Name	Equipment Part Graphic Image
Pipes	pipe7.bmp		pipe8.bmp	
	pipe9.bmp			
Switches	sw1.bmp		sw2.bmp	
	sw3.bmp			
Tanks	tanka.bmp		tanke.bmp	



Image Type	File Name	Equipment Part Graphic Image	File Name	Equipment Part Graphic Image
Tanks	tankf.bmp		tankg.bmp	
	tankh.bmp		tanki.bmp	
	tankj.bmp		tankk.bmp	

# Allen-Bradley PLCs

Image Type	File Name	Equipment Part Graphic Image			
Tanks	tank1.bmp				
Valves	vlv1.bmp		Valves	vlv3.bmp	

## ASCII Character Set

The following table lists the ASCII character set. For characters 0 to 31, see Appendix B, *The Extended Character Set*, in the *PanelBuilder 1400e Configuration Software for Windows User Manual*.

Dec	Oct	Hex	Char	Dec	Oct	Hex	Char	Dec	Oct	Hex	Char
32	040	20	SP	64	100	40	@	96	140	60	\
33	041	21	!	65	101	41	A	97	141	61	a
34	042	22	"	66	102	42	B	98	142	62	b
35	043	23	#	67	103	43	C	99	143	63	c
36	044	24	\$	68	104	44	D	100	144	64	d
37	045	25	%	69	105	45	E	101	145	65	e
38	046	26	&	70	106	46	F	102	146	66	f
39	047	27	'	71	107	47	G	103	147	67	g
40	050	28	(	72	110	48	H	104	150	68	h
41	051	29	)	73	111	49	I	105	151	69	i
42	052	2A	*	74	112	4A	J	106	152	6A	j
43	053	2B	+	75	113	4B	K	107	153	6B	k
44	054	2C	,	76	114	4C	L	108	154	6C	l
45	055	2D	-	77	115	4D	M	109	155	6D	m
46	056	2E	.	78	116	4E	N	110	156	6E	n
47	057	2F	/	79	117	4F	O	111	157	6F	o
48	060	30	0	80	120	50	P	112	160	70	p
49	061	31	1	81	121	51	Q	113	161	71	q
50	062	32	2	82	122	52	R	114	162	72	r
51	063	33	3	83	123	53	S	115	163	73	s
52	064	34	4	84	124	54	T	116	164	74	t
53	065	35	5	85	125	55	U	117	165	75	u
54	066	36	6	86	126	56	V	118	166	76	v
55	067	37	7	87	127	57	W	119	167	77	w
56	070	38	8	88	130	58	X	120	170	78	x
57	071	39	9	89	131	59	Y	121	171	79	y
58	072	3A	:	90	132	5A	Z	122	172	7A	z
59	073	3B	;	91	133	5B	[	123	173	7B	{
60	074	3C	<	92	134	5C	\	124	174	7C	
61	075	3D	=	93	135	5D	]	125	175	7D	}
62	076	3E	>	94	136	5E	^	126	176	7E	~
63	077	3F	?	95	137	5F	—	127	177	7F	DEL

## A

- Arcs, 27
- Arrows, 28, 35
- ASCII display, D-1
  - about, 1
  - configuring, 4
  - control sequences, 3
  - invalid control sequences, 3
  - special characters, 3
  - string format, 3
- ASCII extended character set, 149, D-1
- ASCII input, 5
  - about, 5
  - buttons, 7
  - configuring, 9
  - displays, 6

## B

- Bar graph, 11
  - about, 11
  - configuring, 12
- Bitmaps. *See* Graphic images

## C

- Configuring
  - decimal point, for input objects, 75
  - Enter key handshake, 78
  - objects
    - ASCII display, 4
    - ASCII input, 9
    - bar graph, 12
    - trends, 157
  - control list selector with enter key, 15
  - control list selector without enter key, 18
  - cursor list, 108
  - date display, 152
  - decrement value button, 52
  - goto configure mode button, 34
  - goto screen button, 102
  - increment value button, 49
  - interlocked push button, 95
  - latched push button, 88
  - list indicator, 42
  - local message display, 44

- local message object list, 124
- maintained push button, 90
- multistate indicator, 40
- multistate indicator object list, 123
- multistate push button, 92
- normally closed momentary push button, 86
- normally open momentary push button, 83
- numeric data display, 55
- numeric data display object list, 125
- numeric entry keypad, 70
- numeric input cursor point, 63
- numeric keypad enable button, 58
- return to previous screen button, 102
- scales, 98
- screen keypad enable button, 106
- screen list selector, 104
- screen print button, 99
- screen select keypad, 105
- set bit cursor point, 25
- symbols, 146
- time display, 152
- pens, in trends, 158
- scales, 97
- write expressions, 79

- Control, defined, P-3
- Control list selector with enter key, 13, 14, 94
  - configuring, 15
- Control list selector without enter key, 13, 17
  - configuring, 18
- Control selectors, 13
  - about, 13
  - controls, 13
- Controls, in trends, 154
- Copying, graphic images, 36
- Cursor list
  - See also* Scrolling list
  - buttons, configuring, 111, 116
  - configuring, 108
  - control values, configuring, 114
  - font, configuring, 118
  - number of states, 108
  - number of visible states, 109
  - preview states, 110
  - skipped states, configuring, 115

**D**

Data points, in trends, 154  
Date display, 151  
  about, 151  
  configuring, 152  
Decimal point, configuring for input objects,  
  75  
Decrement value button, 47, 48  
  configuring, 52  
Display objects, about, 47  
Drawing objects, 27, 35

**E**

Editing, array of numeric values, 72  
Ellipses, 28  
Emergency stops, push buttons, 81, 83, 85  
Enter key handshake, configuring, 78  
Exporting, graphic images, 36  
Expressions, using write expressions, 79

**F**

Foreground/Background plotting, in trends,  
  154

**G**

Goto configure mode, 31  
Goto configure mode button  
  configure mode, 31  
  configuring, 34  
  description, 31  
  run mode, 31  
  security, 32, 33  
  software mode switching, 32  
Goto screen button, 101, 102  
  configuring, 102  
Graphic images, A-1, B-1, C-1  
  arrows, 35  
  copying, 36  
  exporting, 36  
  IMAGES directory, 35

importing, 35  
ISA symbols, 35  
library, 35  
sizing, 36  
symbols, A-1, B-1, C-1

**H**

Handshaking, with the PLC, 78  
Hardware, requirements, P-4  
Help. *See* Online help

**I**

Icons. *See* Symbols  
Increment value button, 47, 48  
  configuring, 49  
Input objects, about, 47  
Interlocked push button, 81, 94  
  configuring, 95  
ISA symbols, 35, 145

**K**

Keypad screen selector, 105

**L**

Labels, configuring, in trends, 159  
Latched push button, 81, 87  
  configuring, 88  
Lines, 28  
List indicator, 39, 41  
  configuring, 42  
Local message display, 43  
  about, 43  
  configuring, 44  
Local message object list, 119  
  configuring, 124  
  number of states, 124  
  number of visible states, 124  
Local messages, 43  
  triggering, 44

**M**

- Maintained push button, 81, 89
  - configuring, 90
- Multistate indicator, 39
  - configuring, 40
- Multistate indicator object list, 119
  - configuring, 123
  - number of states, 123
  - number of visible states, 123
- Multistate push button, 81, 91
  - configuring, 92

**N**

- Normally closed momentary push button, 81, 85
  - configuring, 86
- Normally open momentary push button, 81, 82
  - configuring, 83
- Numeric data display, 47, 53
  - configuring, 55
    - decimal point position, 55
    - polarity, 55
    - scaling formula, 54
- Numeric data display object list, 119, 125
  - configuring, 125
- Numeric entry keypad, 47, 69
  - configuring, 70
- Numeric input cursor point, 47, 60
  - configuring, 63
    - decimal point, 62
    - defining character, 62
    - using at runtime, 60
- Numeric keypad enable button, 47, 57
  - configuring, 58
- Numerics, 47
  - about, 47
  - editing array of numeric values, 72

**O**

- Object list
  - See also* Scrolling list
  - local message, 119
  - multistate indicator, 119
  - numeric data display, 119
  - types, 119

**Objects**

- arcs, 27
  - arrows, 28
  - ASCII display, 1
  - ASCII input, 5
  - control list selector with enter key, 13, 14
  - control list selector without enter key, 13, 17
  - cursor list. *See* Scrolling list
  - date display, 151
  - decrement value button, 47, 48
  - drawing objects, 27
  - ellipses, 28
  - goto screen button, 101, 102
  - graphic objects, 35
  - increment value button, 47, 48
  - interlocked push button, 81
  - ISA symbols, 145
  - latched push button, 81
  - lines, 28
  - list indicator, 39, 41
  - local message display, 43
  - maintained push button, 81
  - multistate indicator, 39
  - multistate push button, 81
  - normally closed momentary push button, 81
  - normally open momentary push button, 81
  - numeric data display, 47, 53
  - numeric data display object list, 125
  - numeric entry keypad, 47, 69
  - numeric input cursor point, 47, 60
  - numeric keypad enable button, 47, 57
  - object list. *See* scrolling list
  - panels, 29
  - rectangles, 29
  - return to previous screen button, 101, 102
  - screen keypad enable button, 101, 106
  - screen list selector, 101, 103
  - screen print button, 99
  - screen select keypad, 101, 105
  - scrolling list, 107
  - set bit cursor point, 13, 20
  - symbols, 145
  - text, 35
  - time display, 151
  - wedges, 29
- Online help, P-4
- Out of range values, in trends, 155

**P**

PanelBuilder 1400e  
  README.TXT file, P-2  
  related publications, P-1  
  software registration, P-1  
  support services, P-4  
  Version 4 features, P-1

Panels, 29

Pen value labels, configuring, 159

Pens  
  configuring, 158  
  configuring value labels, in trends, 159  
  maximum in trends, 153

PLC  
  handshaking, 78  
  message triggering, 44

Printers, and screen prints, 99

Publications, related, P-1

Push buttons, 81  
  differences between, 82  
  emergency stops, 81, 83, 85  
  function, 81  
  interlocked, 94  
  latched, 87  
  maintained, 89  
  multistate, 91  
  normally closed momentary, 85  
  normally open momentary, 82  
  safety considerations, 81, 83, 85  
  types, 81

**R**

README.TXT file, about, P-2

Rectangles, 29

Registering PanelBuilder 1400e, P-1

Related publications, P-1

Requirements  
  hardware, P-4  
  software, P-4

Retain cursor on cancel, 22, 62, 68

Return to previous screen button, 101, 102  
  configuring, 102

**S**

Safety considerations, push buttons, 81, 83, 85

Scales, 97  
  about, 97  
  configuring, 97, 98  
  customizing, 97

Screen keypad enable button, 101, 106  
  configuring, 106

Screen list selector, 101, 103  
  configuring, 104

Screen print button, 99  
  about, 99  
  configuring, 99  
  printer compatibility, 99

Screen select keypad, 101  
  configuring, 105

Screen selectors, 101  
  about, 101

Scrolling list, 107  
  about, 107  
  example, 128  
  ladder logic, 134

security, 32

Set bit cursor point, 13, 20  
  configuring, 25  
  default operation, 22  
  defining character, 24  
  defining display field, 25  
  operation on power-up, 23  
  retained default operation, 23  
  using, 21

Sizing, graphic images, 36

Skipped states, configuring, in scrolling lists, 115

Software, requirements, P-4

Software mode switch, 32, 33  
  disable, 34  
  enable, 34  
  terminal behavior at power-up, 34

Software registration, P-1

Support services, P-4

Symbols, 145, A-1, B-1, C-1  
  about, 145  
  configuring, 146  
  states, 145

**T**

Technical support services, P-4

Terminology, P-3

Terms, P-3

Text, 35

about, 149

label, 149

Time display, 151

about, 151

configuring, 152

Trends, 153

about, 153

configuring, 157

controls in, 154

data points, maximums, 154

foreground/background plotting, 154

maximums, 153

out of range values, 155

pens, maximums, 153

Triggering, local messages, 44

**W**

Wedges, 29

Write expressions, using, 79





Rockwell Automation helps its customers receive a superior return on their investment by bringing together leading brands in industrial automation, creating a broad spectrum of easy-to-integrate products. These are supported by local technical resources available worldwide, a global network of system solutions providers, and the advanced technology resources of Rockwell.

## Worldwide representation.



Argentina • Australia • Austria • Bahrain • Belgium • Bolivia • Brazil • Bulgaria • Canada • Chile • China, People's Republic of • Colombia • Costa Rica • Croatia • Cyprus • Czech Republic • Denmark • Dominican Republic • Ecuador • Egypt • El Salvador • Finland • France • Germany • Ghana • Greece • Guatemala • Honduras • Hong Kong • Hungary • Iceland • India • Indonesia • Iran • Ireland • Israel • Italy • Jamaica • Japan • Jordan • Korea • Kuwait • Lebanon • Macau • Malaysia • Malta • Mexico • Morocco • The Netherlands • New Zealand • Nigeria • Norway • Oman • Pakistan • Panama • Peru • Philippines • Poland • Portugal • Puerto Rico • Qatar • Romania • Russia • Saudi Arabia • Singapore • Slovakia • Slovenia • South Africa, Republic of • Spain • Sweden • Switzerland • Taiwan • Thailand • Trinidad • Tunisia • Turkey • United Arab Emirates • United Kingdom • United States • Uruguay • Venezuela

Rockwell Automation Headquarters, 1201 South Second Street, Milwaukee, WI 53204-2496 USA, Tel: (1) 414 382-2000 Fax: (1) 414 382-4444

Rockwell Automation European Headquarters, Avenue Hermann Debroux, 46, 1160 Brussels, Belgium, Tel: (32) 2 663 06 00, Fax: (32) 2 663 06 40

Rockwell Automation Asia Pacific Headquarters, 27/F Citicorp Centre, 18 Whitfield Road, Causeway Bay, Hong Kong, Tel: (852) 2887 4788, Fax: (852) 2508 1846

World Wide Web: <http://www.ab.com>

# Allen-Bradley PLCs