



Allen-Bradley

*Hand-Held
Decoded Bar
Code Scanners*

(Cat. No. 2755-HDG-4)

Bar Code Programming Guide

AB Spares

Important User Information

Because of the variety of uses for the products described in this publication, those responsible for the application and use of this control equipment must satisfy themselves that all necessary steps have been taken to assure that each application and use meets all performance and safety requirements, including any applicable laws, regulations, codes and standards.

The illustrations, charts, sample programs and layout examples shown in this guide are intended solely for purposes of example. Since there are many variables and requirements associated with any particular installation, Allen-Bradley does not assume responsibility or liability (to include intellectual property liability) for actual use based upon the examples shown in this publication.

Allen-Bradley publication SGI-1.1, *Safety Guidelines for the Application, Installation, and Maintenance of Solid-State Control* (available from your local Allen-Bradley office), describes some important differences between solid-state equipment and electromechanical devices that should be taken into consideration when applying products such as those described in this publication.

Reproduction of the contents of this copyrighted publication, in whole or in part, without written permission of Allen-Bradley Company, Inc., is prohibited.

Throughout this manual we use notes to make you aware of safety considerations:



ATTENTION: Identifies information about practices or circumstances that can lead to personal injury or death, property damage or economic loss.

Attention statements help you to:

- identify a hazard
- avoid the hazard
- recognize the consequences

Important: Identifies information that is critical for successful application and understanding of the product.

Table of Contents

Read this First

Configuration Bar Code Symbols	P-1
How To Use this Guide	P-2
Contents	P-3

Chapter 1 Scanner Configuration (for Synapse Cables)

Important Note	1-1
Scan These Symbols First	1-2
Select the Symbologies You Want to Enable or Disable	1-4
Select UPC / EAN Options	1-8
Select Codabar Options	1-12
Select Code 39 Options	1-13
Select MSI / Plessey Options	1-14
Select Interleaved and Discrete 2 of 5 Options	1-15
Select Prefix / Suffix Options	1-17
Select Transmission Format	1-19
Transmit No-Read Message	1-20
Transmit Code ID Character	1-20
Transmit AIM ID Character	1-21
Audible Response	1-21
Power Mode	1-21
Laser On Timeout	1-22
Hands-Free (Stand) Timeout	1-23

AB Spares

Chapter 2 Scanner Configuration (for AdaptaScan Pass Through Cable)

Important Note	2-1
Scan These Symbols First	2-2
Select the Symbologies You Want to Enable or Disable	2-4
Select UPC / EAN Options	2-8
Select Codabar Options	2-12
Select Code 39 Options	2-13
Select MSI / Plessey Options	2-14
Select Interleaved and Discrete 2 of 5 Options	2-15
Select Prefix / Suffix Options	2-17
Select Transmission Format	2-19
Transmit No-Read Message	2-19
Transmit Code ID Character	2-20
Transmit AIM ID Character	2-20
Audible Response	2-21
Power Mode	2-21
Laser On Timeout	2-22
Hands-Free (Stand) Timeout	2-24
AdaptaScan Pass Through Cable Configuration	2-25
AdaptaScan Pass Through Baud Rate	2-26
AdaptaScan Pass Through Parity Options	2-27
AdaptaScan Pass Through Stop and Data Bits	2-28
AdaptaScan Pass Through Hardware Handshaking	2-29
AdaptaScan Pass Through Software Handshaking	2-30
AdaptaScan Pass Through Beep on <BEL>	2-31
AdaptaScan Pass Through Set Intercharacter Delay	2-32

Chapter 3 RS-232 Synapse Cable (Communication Setup)

RS-232 Synapse Cable Defaults	3-2
Fixed Format Hosts	3-3
Baud Rate	3-4
Parity Options	3-5
Stop and Data Bits	3-6
Hardware Handshaking	3-8
Software Handshaking	3-7
Beep on <BEL>	3-9
Unknown Characters	3-9
Response Timeout	3-10
Advanced Features	3-12

Chapter 4 IBM Keyboard Wedge Synapse Cable (Communication Setup)

IBM Keyboard Wedge Synapse Cable Defaults	4-1
Host	4-2
Country Selection	4-3
Unknown Characters	4-4
Intercharacter Delay	4-4
Advanced Features	4-5

Chapter 5 DEC VT520 Keyboard Wedge Synapse Cable (Communication Setup)

DEC VT520 Keyboard Wedge Synapse Cable Defaults	5-1
Host	5-2
Country Selection	5-2
Unknown Characters	5-4
Intercharacter Delay	5-4
Advanced Features	5-5

AB Spares

**Chapter 6 DEC VT220/320/420 Keyboard Wedge Synapse Cable
(Communication Setup)**

DEC VT220/320/420 Keyboard Wedge Synapse Cable Defaults . .	6-1
Host	6-2
Country Selection	6-2
Unknown Characters	6-4
Intercharacter Delay	6-4
Advanced Features	6-5

**Chapter 7 Scanner Emulation Synapse Cable
(Communication Setup)**

Scanner Emulation Synapse Cable Defaults	7-1
Host	7-2
Variable Leading Margin	7-3
Check for Decode LED	7-3
Timeout	7-4
Polarity	7-5
Unknown Characters	7-5
Convert All to Code 39	7-6
Code 39 to Code 39 Full ASCII	7-6
Advanced Features	7-7

Appendix A Enhanced Decoder Application

Hardware Connections	A-2
Scanner Configuration	A-2
Configuration Codes for Enhanced Decoder Application	A-3
Enhanced Decoder Setup for Scanner Input	A-4
Enhanced Decoder Setup for Auxilliary Port Pass Through	A-5

Appendix B Flexible Interface (RB) Module Application

Hardware Connections	B-2
Scanner Configuration	B-2
Configuration Codes for Flexible Interface Module Application	B-3
Flexible Interface Module Setup	B-4

Appendix C SLC 5/03, 5/04 Application

Hardware Connections	C-2
Scanner Configuration	C-2
Configuration Codes for SLC Application	C-3
SLC 5/03, 5/04 Setup	C-5
SLC Program	C-7

Appendix D PLC-5 Controller Application

Hardware Connections	D-2
Scanner Configuration	D-2
Configuration Codes for PLC Application	D-3
PLC Setup	D-5
PLC Program	D-7

Appendix E AdaptaScan Pass Through Application

Hardware Connections	E-1
Configuration Codes for AdaptaScan Pass Through Application	E-3
AdaptaScan Setup	E-5

Appendix F DTAM Plus DeviceNet Application

Hardware Connections	F-2
Configuration Codes for DTAM Plus DeviceNet Application	F-3
DTAM Plus Setup	F-5
DeviceNet Operation	F-6

Appendix G ASCII Chart

Read this First

This guide provides the configuration bar codes for the following:

- Decoded Hand-Held Bar Code Scanner
(Catalog No. 2755-HDG-4)
- RS-232 Synapse Cables
(Catalog No. 2755-HFC-SR2-01, 2755-HFC-SR3-01)
- IBM or Compatible Keyboard Wedge Synapse Cables
(Catalog No. 2755-HFC-SP1-01, 2755-HFC-SP2-01)
- DEC Keyboard Wedge Synapse Cables
(Catalog No. 2755-SV1-01, 2755-SV2-01)
- Scanner Emulation Synapse Cable
(Catalog No. 2755-HFC-SA1-01)

Configuration Bar Code Symbols

The configuration bar code symbols are all Code 128. The scanner is always enabled to read Code 128 symbols. Default settings are indicated by an asterisk.



9600*

Indicates this Symbol
is the Default Setting

Refer to the user manual for the decoded hand-held scanners
(Publication 2755-6.2) for descriptions of the configuration settings.

AB Spares

How to Use this Guide

The following shows a typical sequence for configuring a scanner.

1. Connect scanner to host and apply power.
2. Configure scanner. What type of cable is connected to the scanner?

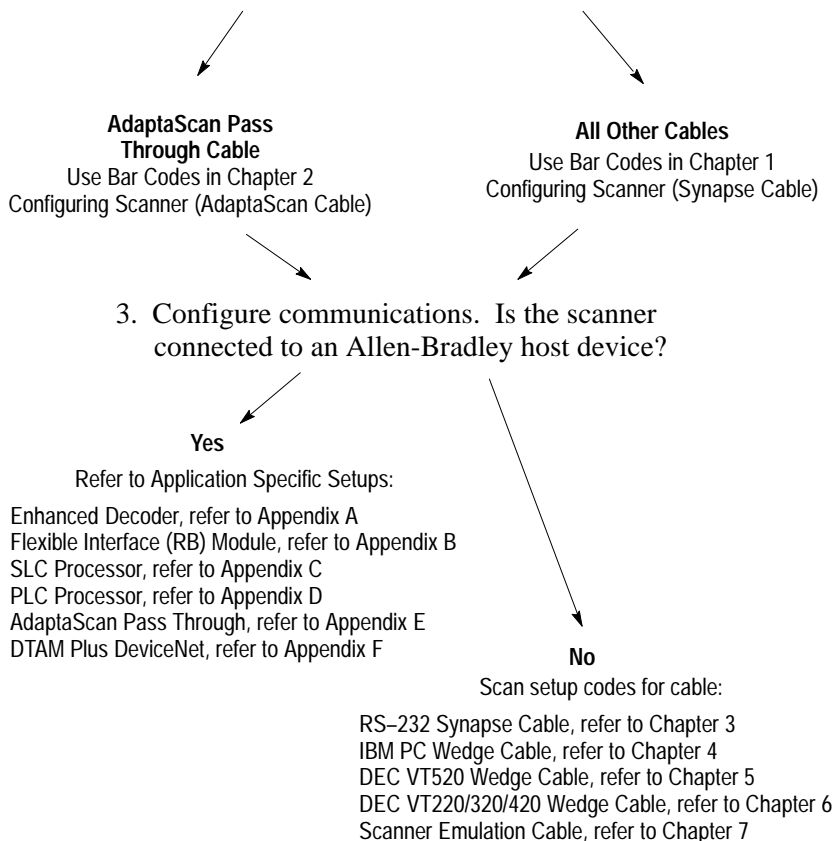

4. Scanner is ready for operation. Use the test codes found on the inside back cover of this guide.

Contents

The configuration bar codes are separated into four tabbed sections:

Scanner Configuration for Synapse Cables

Scanner / Cable Configuration for AdaptaScan Cable

Communications Setup for Synapse Cables

Application Specific Configurations

AB Spares

Scanner Configuration (for Synapse Cables)

Important:

Use the bar codes in this section to configure the scanner for use with one of the following Synapse cables:

Scanner Emulation Cable (Catalog No. 2755-HFC-SA1-01)

IBM XT/AT Keyboard Wedge (Catalog No. 2755-HFC-SP1-01)

PS/2 Keyboard Wedge (Catalog No. 2755-HFC-SP2-01)

RS-232, 25-pin (Catalog No. 2755-HFC-SR2-01)

RS-232, 9-pin (Catalog No. 2755-HFC-SR3-01)

DEC VT510/520 Keyboard Wedge (Catalog No. 2755-HFC-SV2-01)

DEC VT220/320/420 Keyboard Wedge (Catalog No. 2755-HFC-SV1-01)

Do not use these configuration codes if you are using the scanner with an **AdaptaScan Pass Through Cable** (Catalog No. 2755-HDC-GA2-08). Refer to Chapter 2 Scanner Configuration (for AdaptaScan Pass Through Cable).

Scan These Symbols First

Scan both of these labels in sequence to set the scanner to the default settings for use with a Synapse cable.



Scan this Symbol First

then



Set Scanner for Synapse Cable Operation

Important: You must then scan the following label to enable Synapse communications.



Enable Synapse Cable Communication

Also scan the ENABLE SYNAPSE CABLE COMMUNICATION bar code to change the configuration from AdaptaScan Pass Through to the Synapse cable configuration.

When the Synapse cable communication is enabled, scan the appropriate bar codes to configure the scanner. Then, scan the appropriate bar codes to configure the Synapse cable.

AB Spares

The scanner is now set to these defaults:

Item	Default Setting	Code on Page:
Cable Type	Synapse Cable	1-2
Symbologies	All Enabled	1-4
Transmit UPC-A Check Digit	Enabled	1-8
Transmit UPC-E Check Digit	Enabled	1-8
Convert UPC-E to UPC-A	Disabled	1-8
EAN Zero Extend	Disabled	1-9
Decode UPC / EAN Supplemental	Disabled	1-9
UPC-A Preamble	System Character	1-10
UPC-E Preamble	System Character	1-10
UPC/EAN Security Level	0	1-11
CLSI Editing	Disabled	1-12
NOTIS Editing	Disabled	1-12
Codabar Decode Redundancy	Disabled	1-12
Transmit Code 39 Check Digit	Disabled	1-13
Buffer Code 39	Disabled	1-13
Code 39 Full ASCII	Disabled	1-13
MSI Plessey Check Digit	One	1-14
MSI Plessey 2 Check Digit Algorithm	Mod 10 - Mod 10	1-14
Convert Interleaved 2 of 5 (14 digit) to EAN 13	Disabled	1-15
Interleaved Code Length	14	1-15
Discrete 2 of 5 Code Length	12	1-15
Prefix/Suffix	None	1-17
Data Transmission Format	Data As Is	1-19
Transmit No-Read Message	Disabled	1-20
Transmit Code ID Character	Disabled	1-20
Transmit AIM ID Character	Disabled	1-21
Audible Response	Enabled	1-21
Power Mode	Continuous	1-21
Laser On Timeout	3 Seconds	1-22
Hands-Free Stand Operation Timeout	60 minutes	1-23

Select The Symbologies You Want to Enable or Disable

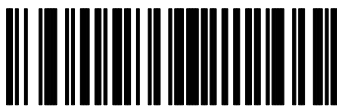

Enable Code 39*



Disable Code 39

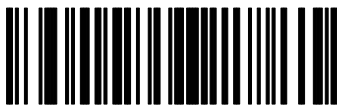

Enable UPC-A*



Disable UPC-A



Enable UPC-E*

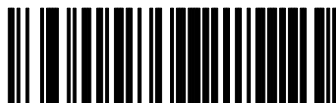

Disable UPC-E

AB Spares



Enable Codabar*

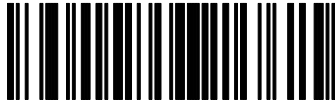

Disable Codabar



Enable EAN 8*

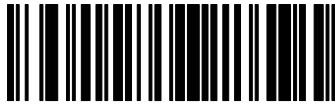

Disable EAN 8



Enable EAN 13*

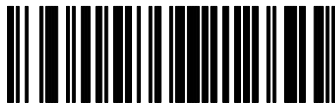

Disable EAN 13

Select The Symbologies You Want to Enable or Disable

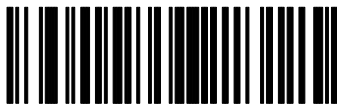

Enable Interleaved 2 of 5*

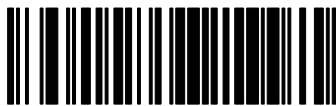

Disable Interleaved 2 of 5



Enable Discrete 2 of 5*

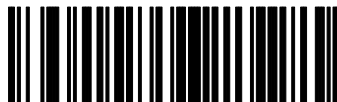

Disable Discrete 2 of 5



Enable Code 128*



Disable Code 128

Note: The scanner is always enabled to read Code 128 configuration codes.



Enable MSI / Plessey*

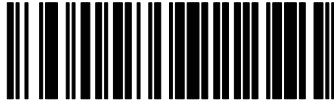

Disable MSI / Plessey

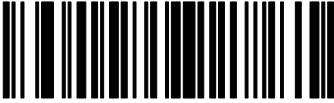

Enable Code 93*

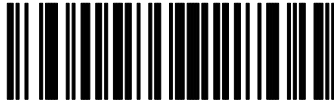

Disable Code 93

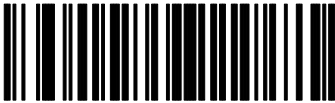

Enable EAN 128*



Delete EAN 128

Select UPC / EAN Options



Transmit UPC-A Check Digit*



Do Not Transmit UPC-A Check Digit



Transmit UPC-E Check Digit*



Do Not Transmit UPC-E Check Digit



Convert UPC-E to UPC-A



Do Not Convert UPC-E to UPC-A*

AB Spares



Decode UPC / EAN Supplemental



Ignore UPC / EAN With Supplementals*



Autodiscriminate UPC / EAN with Supplementals

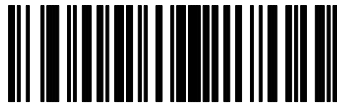

EAN 8 Zero Extend

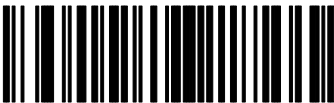

Do Not Extend EAN 8*

Select UPC / EAN Options (Continued)

Scan one of the following Preamble options for UPC-A labels.



No UPC-A Preamble



UPC-A System Character Preamble*



UPC-A System Character and Country Code Preamble

Scan one of the following Preamble options for UPC-E labels.

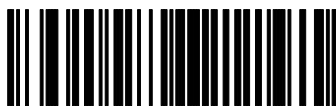

No UPC-E Preamble

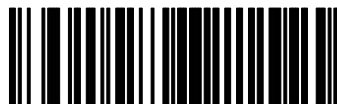

UPC-E System Character Preamble*

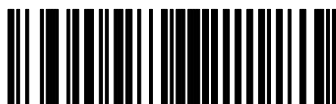

UPC-E System Character and Country Code Preamble

Scan one of the symbols below to change the security level. The security level determines the scanner's ability to read labels without misreads.

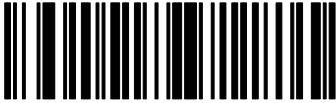

Security Level 0 *



Security Level 1

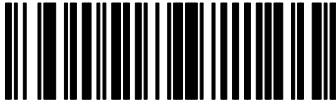

Security Level 2

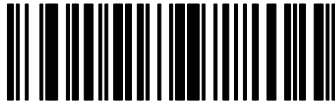

Security Level 3

Select Codabar Options

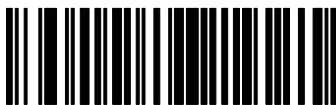

Enable NOTIS Editing



Disable NOTIS Editing*



Enable CLSI Editing



Disable CLSI Editing*



Enable Decode Redundancy



Disable Decode Redundancy*

AB Spares

Select Code 39 Options



Verify Code 39 Check Digit

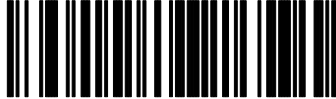

Do Not Verify Code 39 Check Digit*



Enable Code 39 Buffering



Disable Code 39 Buffering*



Clear Code 39 Buffer ①

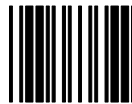

Transmit Code 39 Buffer ①



Enable Code 39 Full ASCII



Disable Code 39 Full ASCII*

① The Clear Buffer and Transmit Buffer bar codes are operating functions not configuration codes.

Select MSI / Plessey Options



Verify One MSI / Plessey Check Digit*

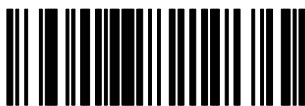

Verify Two MSI / Plessey Check Digits

If verifying 2 check digits, select Mod 10 - Mod 10 or Mod 11 - Mod 10 format.



MSI 2 Check Digits (Mod 10 - Mod 10)*



MSI 2 Check Digits (Mod 11 - Mod 10)

AB Spares

Select Interleaved and Discrete 2-of-5 Options



Enable I 2 of 5 (14 digit) to EAN 13 Conversion

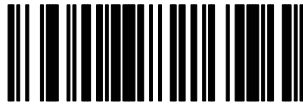

Disable I 2 of 5 (14 digit) to EAN 13 Conversion*

If entering code lengths, scan the applicable label below followed by the two digit length on the next page. **Note:** The scanner cannot be set to read 'any' bar code length. You must specify a length(s).

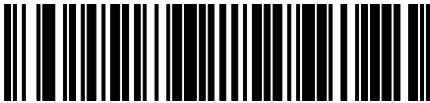

Discrete 2 of 5 Length 1
(Range 02-31)



Discrete 2 of 5 Length 2
(Range 00*-31)

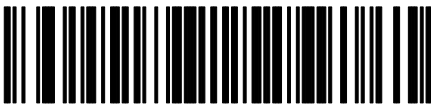

Interleaved 2 of 5 Length 1
(Range 02-31)



Interleaved 2 of 5 Length 2
(Range 00*-31)

Scan 2 Digit Code Length



Cancel (Clears Code Length)



AB Spares

Select Prefix / Suffix Options

To enter a prefix, scan the Prefix or Suffix label followed by the four digit ASCII equivalent value (See Appendix G). For example the ASCII equivalent for CR LF is 7013. The default is no prefix or suffix.



Prefix

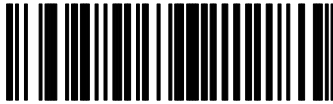

Suffix

Scan 4 Digit ASCII Equivalent Value



0



2



4



6

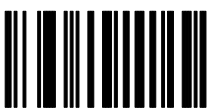

8



Cancel (Clears Code Length)



1



3

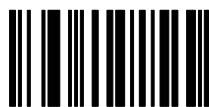

5



7



9

AB Spares

Select Transmission Format



Send Data As Is (No Prefix / Suffix)*

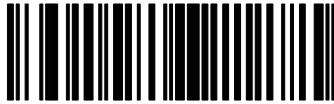

Send Prefix then Data

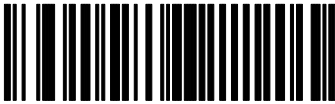

Send Data then Suffix



Send Prefix then Data then Suffix

Transmit No-Read Message

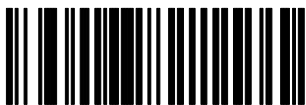

Send NR Message with No-Read



Do Not Send NR Message with No-Read*

Transmit Code ID Character

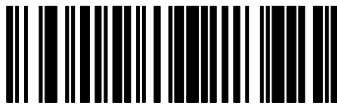

Transmit Code ID Character



Do Not Transmit Code ID Character*

AB Spares

Transmit AIM ID Character



Do Not Transmit AIM ID Character*

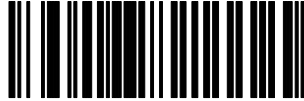

Transmit AIM ID Character

Audible Response

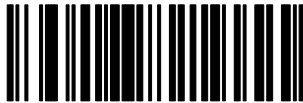

Beep After Decode*



Do Not Beep After Decode

Power Mode



Low Power



Continuous On*

Note: When the scanner is in low power mode and a label is scanned, the first character of the first symbol scanned will not be read as the scanner powers up. Use continuous mode if this causes a problem with your application (such as stand mode or A-B Basic Module applications).

Laser On Timeout

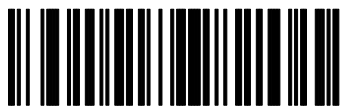

0.5 Seconds



1.0 Seconds



1.5 Seconds



2.0 Seconds



2.5 Seconds



3.0 Seconds*



3.5 Seconds



4.0 Seconds



4.5 Seconds



5.0 Seconds

AB Spares

Hands-Free (Stand) Timeout

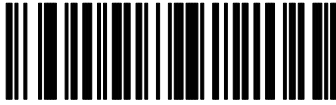

15 Minutes



30 Minutes



45 Minutes

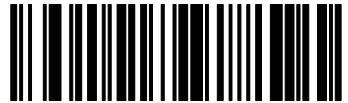

60 Minutes*



75 Minutes



90 Minutes

Scanner Configuration (for AdaptaScan Pass Through Cable)

Important:

Use the bar codes in this Chapter to configure the scanner for use with the AdaptaScan Pass Through Cable:

(Catalog No. 2755-HDC-GA2-08)

Do not use these configuration codes if you are using a Synapse cable. Refer to section Scanner Configuration for Synapse Cables.

This Chapter also contains the configuration bar codes for the cable beginning on page 2-25.

Before You Configure the Scanner

Appendix E provides a condensed version of the scanner configuration and connections that is suitable for many AdaptaScan applications. Appendix E uses default settings with a few modifications that allow communications with an AdaptaScan RS-232 port. Appendix E does not provide codes for all of the options listed in this chapter. An optional method of configuring the scanner is to use the configuration codes in Appendix E and then scan the codes (in this chapter) for items you want to change.

Refer to Appendix E before you begin to determine if the condensed version of the configuration meets your application's requirements.

Scan These Symbols First

Scan all three of these labels in sequence to set the scanner to the default settings for use with an AdaptaScan Pass Through Cable.



Scan this Symbol First

then



Set Scanner for AdaptaScan Pass Through Cable Operation

Important: You must then scan the following label to enable the AdaptaScan Pass Through Communications.



Enable AdaptaScan Pass Through Cable Communications

Also scan the ENABLE ADAPTASCAN PASS THROUGH CABLE COMMUNICATION bar code to change the configuration from Synapse communication to the AdaptaScan Pass Through configuration.

When AdaptaScan Pass Through communications is enabled, scan the appropriate bar codes to configure the scanner. Then, scan the appropriate bar codes to configure the AdaptaScan Pass Through cable.

The scanner is now set to these defaults:

Item	Default Setting	Code on Page:
Cable Type	AdaptaScan Pass Through Cable	2-2
Symbologies	All Enabled	2-4
Transmit UPC-A Check Digit	Enabled	2-8
Transmit UPC-E Check Digit	Enabled	2-8
Convert UPC-E to UPC-A	Disabled	2-8
EAN Zero Extend	Disabled	2-9
Decode UPC / EAN Supplemental	Disabled	2-9
UPC-A Preamble	System Character	2-10
UPC-E Preamble	System Character	2-10
UPC Security Level/ EAN	0	2-11
CLSI Editing	Disabled	2-12
NOTIS Editing	Disabled	2-12
Codabar Decode Redundancy	Disabled	2-12
Transmit Code 39 Check Digit	Disabled	2-13
Buffer Code 39	Disabled	2-13
Code 39 Full ASCII	Disabled	2-13
MSI Plessey Check Digit	One	2-14
MSI Plessey 2 Check Digit Algorithm	Mod 10 - Mod 10	2-14
Convert Interleaved 2 of 5 (14 digit) to EAN 13	Disabled	2-15
Interleaved Code Length	14	2-15
Discrete 2 of 5 Code Length	12	2-15
Prefix/Suffix	None	2-17
Data Transmission Format	Suffix Only	2-19
Transmit No-Read Message	Disabled	2-19
Transmit AIM ID Character	Disabled	2-20
Transmit Code ID Character	Disabled	2-20
Beep After Decode	Enabled	2-21
Power Mode	Low Power	2-21
Laser On Timeout	3 Seconds	2-22
Hands-Free Stand Operation Timeout	60 minutes	2-24

Select The Symbologies You Want to Enable or Disable



Enable Code 39 *



Disable Code 39



Enable UPC-A *



Disable UPC-A



Enable UPC-E *



Disable UPC-E

Select The Symbologies You Want to Enable or Disable



Enable Codabar *



Disable Codabar



Enable EAN 8 *

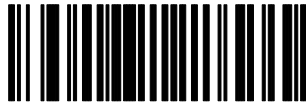

Disable EAN 8



Enable EAN 13 *



Disable EAN 13

ADAPTA Scan



Enable Interleaved 2 of 5 *



Disable Interleaved 2 of 5



Enable Discrete 2 of 5 *



Disable Discrete 2 of 5



Enable Code 128 *



Disable Code 128



Enable MSI / Plessey *



Disable MSI / Plessey

Select The Symbologies You Want to Enable or Disable



Enable Code 93 *

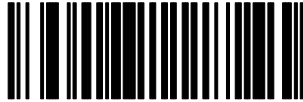

Disable Code 93



Enable EAN 128 *



Disable EAN 128

Note: The scanner is always enabled to read the Code 128 configuration codes used in this manual.

AB Spares

Select UPC / EAN Options



Transmit UPC-A Check Digit *



Do Not Transmit UPC-A Check Digit



Transmit UPC-E Check Digit *



Do Not Transmit UPC-E Check Digit



Convert UPC-E to UPC-A



Do Not Convert UPC-E to UPC-A *

Select UPC / EAN Options (Continued)



Decode UPC / EAN Supplemental

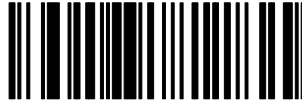

Do Not Decode UPC / EAN Supplemental *



Autodiscriminate UPC / EAN with Supplementals



EAN 8 Zero Extend

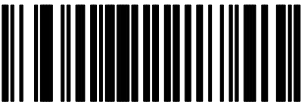

Do Not Extend EAN 8 *

Scan one of the following Preamble options for UPC-A labels.



No UPC-A Preamble



UPC-A System Character Preamble *



UPC-A System Character and Country Code Preamble

Scan one of the following Preamble options for UPC-E labels.



No UPC-E Preamble



UPC-E System Character Preamble *



UPC-E System Character and Country Code Preamble

Select UPC / EAN Options (Continued)

Scan one of the symbols below to change the security level. The security level determines the scanner's ability to read labels without misreads.



Security Level 0 *

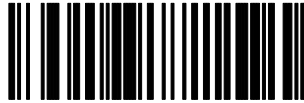

Security Level 1



Security Level 2

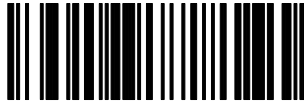

Security Level 3

AB Spares

Select Codabar Options

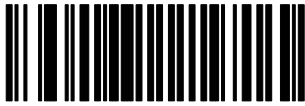

Enable NOTIS Editing

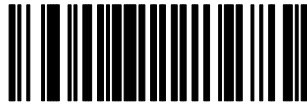

Disable NOTIS Editing *



Enable CLSI Editing

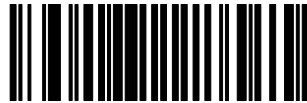

Disable CLSI Editing *

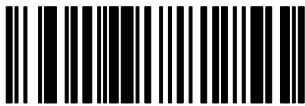

Enable Decode Redundancy



Disable Decode Redundancy *

Select Code 39 Options



Verify Code 39 Check Digit



Do Not Verify Code 39 Check Digit *



Enable Code 39 Buffering

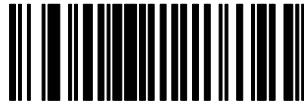

Disable Code 39 Buffering *

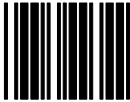

Clear Code 39 Buffer ①

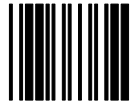

Transmit Code 39 Buffer ①



Enable Code 39 Full ASCII



Disable Code 39 Full ASCII *

① The Clear Buffer and Transmit Buffer bar codes are operating functions not configuration codes

Select MSI / Plessey Options



Verify One MSI / Plessey Check Digit *

If verifying 2 check digits, scan this label and then select Mod 10 - Mod 10 or Mod 11 - Mod 10 format.



Verify Two MSI / Plessey Check Digits

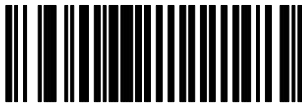

MSI 2 Check Digits (Mod 10 - Mod 10) *



MSI 2 Check Digits (Mod 11 - Mod 10)

Select Interleaved and Discrete 2-of-5 Options



Enable I 2 of 5 (14 digit) to EAN 13 Conversion

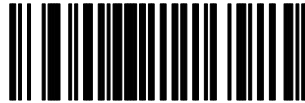

Disable I 2 of 5 (14 digit) to EAN 13 Conversion *

If specifying code lengths, scan the applicable label below followed by the two digit length on the next page.



Discrete 2 of 5 Length 1
(Range 02 - 31)



Discrete 2 of 5 Length 2
(Range 00 - 31)

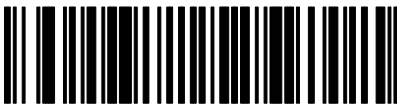

Interleaved 2 of 5 Length 1
(Range 02 - 32)



Interleaved 2 of 5 Length 2
(Range 00 - 32)

Scan 2 Digit Code Length



0



2



4



6



8



Cancel (Clears Code Length)

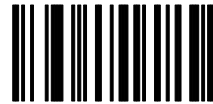

1



3



5



7



9

Select Prefix / Suffix Options

To enter a prefix, scan the Prefix or Suffix label followed by the four digit ASCII equivalent value (See Appendix G). For example the ASCII equivalent for CR LF is 7013. The default is no prefix or suffix.



Prefix



Suffix

Scan 4 Digit ASCII Equivalent Value



0



2



4



6



8



Cancel (Clears Code Length)



1



3



5



7



9

Select Transmission Format



Send Data As Is (No Prefix / Suffix)

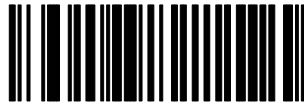

Send Prefix then Data

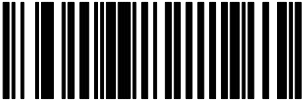

Send Data then Suffix *



Send Prefix then Data then Suffix

Transmit No-Read Message



Send NR Message with No-Read

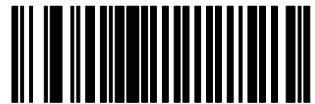

Do Not Send NR Message with No-Read*

AB Spares

Transmit AIM ID Character



Transmit AIM ID Character



Do Not Transmit AIM ID Character *

Transmit Code ID Character



Transmit Code ID Character



Do Not Transmit Code ID Character *

Audible Response



Beep After Decode *

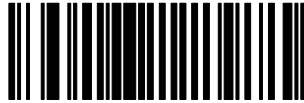

Do Not Beep After Decode

Power Mode

Select either one of the power mode options:



Continuous On

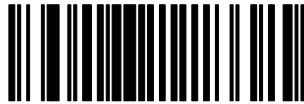

Low Power *

Note: When the scanner is in low power mode and a label is scanned, the first character of the first symbol scanned will not be read as the scanner powers up. Use continuous mode if this causes a problem with your application (such as stand mode or A-B Basic Module applications).

AB Spares

Laser On Timeout

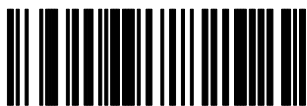

0.5 Seconds



1.0 Seconds



1.5 Seconds



2.0 Seconds



2.5 Seconds



3.0 Seconds*

Laser On Timeout

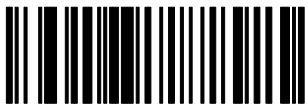

3.5 Seconds



4.0 Seconds



4.5 Seconds



5.0 Seconds

AB Spares

Hands-Free (Stand) Timeout



15 Minutes

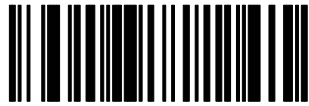

30 Minutes



45 Minutes

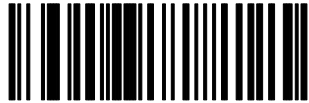

60 Minutes*

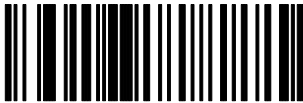

75 Minutes

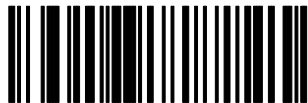

90 Minutes

AdaptaScan Pass Through Cable Configuration

This section provides the configuration bar codes for the AdaptaScan pass through cable:

- (Catalog No. 2755-HDC-GA2-08)

Scan this label to set the AdaptaScan pass through cable to the following default settings:



Set AdaptaScan Pass Through Cable Defaults

Item	Default Setting	Code on Page:
Baud Rate	9600	2-26
Parity	Even ^①	2-27
Stop Bits	2 ^①	2-28
Data Bits	7 ^①	2-28
Hardware Handshaking	None	2-29
Software Handshaking	None	2-30
Beep on BEL	Disabled	2-31
Intercharacter Delay	00	2-32

^① We recommend that you set Parity = None, Stop Bits = 1, and Data Bits = 8 for communication with the AdaptaScan Bar Code Reader.

AdaptaScan Pass Through Baud Rate



600

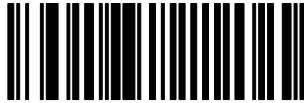

1200

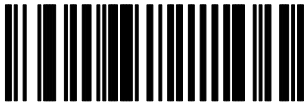

2400

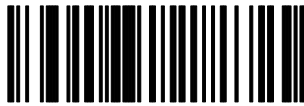

4800

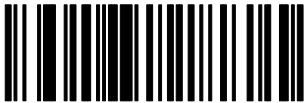

9600 *



19200

AdaptaScan Pass Through Parity Options

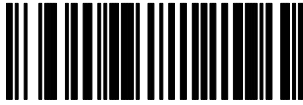

Odd



Even*

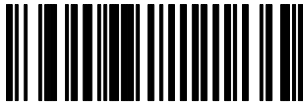

Mark

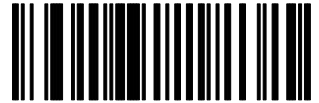

Space

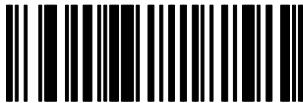

Do Not Check Parity

AdaptaScan Pass Through Stop and Data Bits



One Stop Bit



Two Stop Bits*



7 Data Bits*

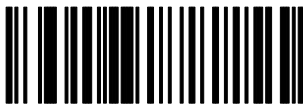

8 Data Bits

AdaptaScan Pass Through Hardware Handshaking

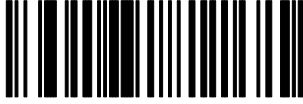

No Hardware Handshaking*

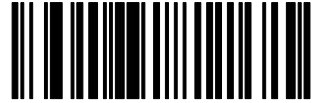

RTS / CTS

AB Spares

AdaptaScan Pass Through Software Handshaking



No Software Handshaking*



ACK / NAK



ENQ Only



ACK / NAK with ENQ



XON / XOFF

AdaptaScan Pass Through Beep on <BEL>



Beep on <BEL>



Do Not Beep on <BEL> *

AB Spares

Set Intercharacter Delay

Scan the Intercharacter delay symbol followed by the two digit delay from 00 to 99 milliseconds (default is 00).



Set Intercharacter Delay



0



1



2



3



4



5



6



7

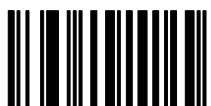

8



9

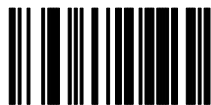

Cancel (Clears Intercharacter Delay)

AB Spares

RS-232 Synapse Cable (Communication Setup)

This chapter provides the configuration bar codes for the following RS-232 Synapse cables:

- (Catalog No. 2755-HFC-SR2-01)
- (Catalog No. 2755-HFC-SR3-01)

Set RS-232 Synapse Cable Defaults

Scan this label to set the default settings for the RS-232 Synapse cable. Defaults are indicated with an asterisk.



Set RS-232 Synapse Cable Defaults

Scan this label to set the RS-232 Synapse cable to the default settings shown below.

Item	Default Setting	Code on Page:
Host	Standard RS-232	3-3
Baud Rate	9600	3-4
Parity	None	3-5
Check Parity	Enabled	3-5
Stop Bits	1	3-6
Data Bits	8	3-6
RTS State	Low	3-7
Hardware Handshaking	None	3-7
Software Handshaking	None	3-8
Beep on BEL	Disabled	3-9
Unknown Characters	Send Bar Codes With Unknown Characters	3-9
Response Timeout	2 Seconds	3-10
Parameter Set	Set #1	3-12

Scan the bar code symbols for the settings you need to change.

AB Spares

RS-232 Synapse Cable Fixed Format Hosts

Currently only one option for fixed format hosts is available. Scan the Standard RS-232 host bar code symbol. Additional hosts may be added at a future date.

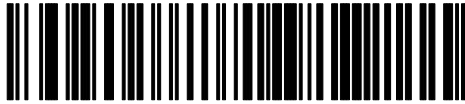

Standard RS-232 *

RS-232 Synapse Cable Baud Rate

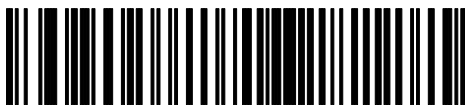

110



300

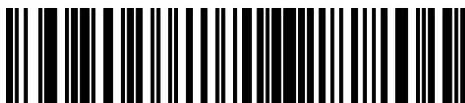

600

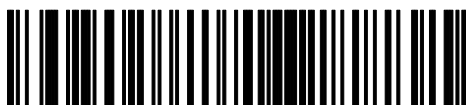

1200

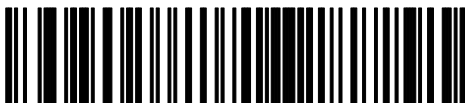

2400



4800

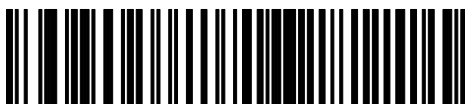

9600 *

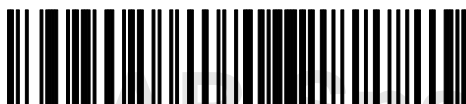

19200

AB Spares

RS-232 Synapse Cable Parity Options

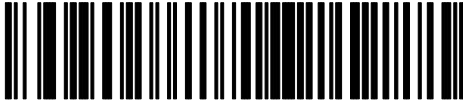

None *



Odd

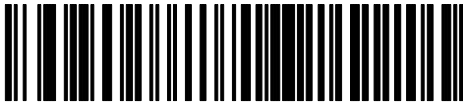

Even



Mark

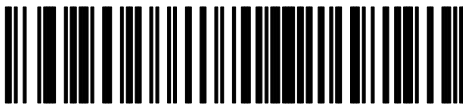

Space

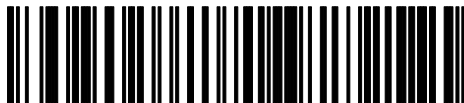

Check Parity*

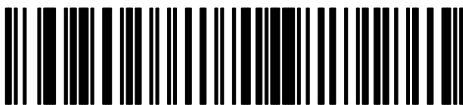

Do Not Check Parity

RS-232 Synapse Cable Stop and Data Bits

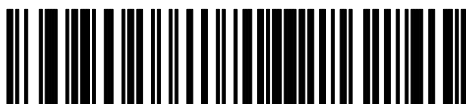

One Stop Bit *

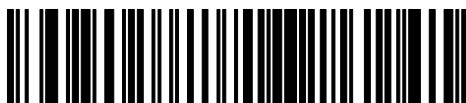

Two Stop Bits

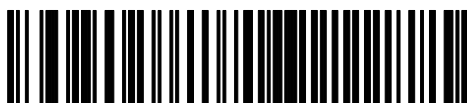

8 Data Bits *

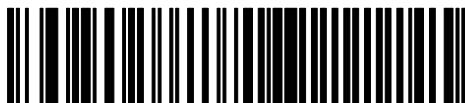

7 Data Bits

AB Spares

RS-232 Synapse Cable Hardware Handshaking



No Hardware Handshaking*



RTS / CTS Enable

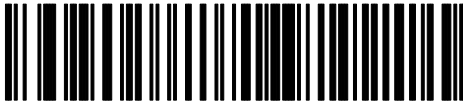

RTS Low *



RTS High

RS-232 Synapse Cable Software Handshaking

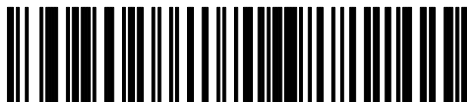

No Software Handshaking*

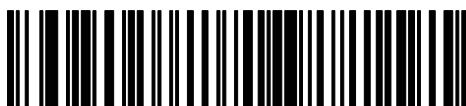

ACK / NAK

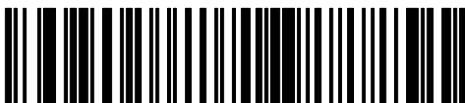

ENQ Only

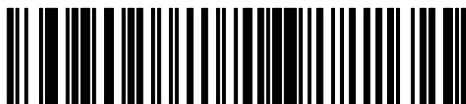

ACK / NAK with ENQ

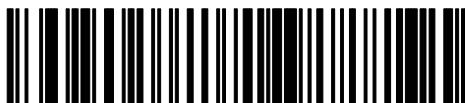

XON / XOFF

AB Spares

RS-232 Synapse Cable Beep On <BEL>



Do Not Beep on <BEL> *



Beep on <BEL>

RS-232 Synapse Cable Unknown Characters

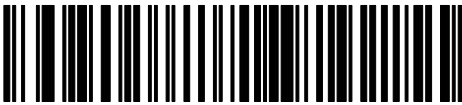

Send Bar Codes with Unknown Characters *

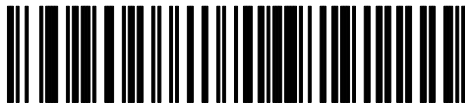

Do Not Send Bar Codes with Unknown Characters

RS-232 Synapse Cable Response Timeout

Scan the following symbol followed by the two digit timeout from 0.0 to 9.9 (default is 2.0 seconds).

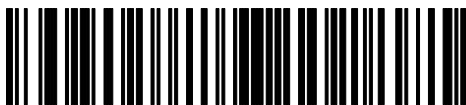

Enter Response Timeout



0



1



2



3



4

AB Spares

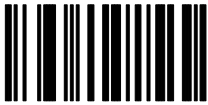

5

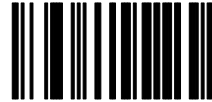

6



7



8



9



Cancel (Clears Entry)

RS-232 Synapse Cable Advanced Features

Scan the following symbols to select the current parameter set and/or set the defaults for each parameter set.



Parameter Set 1 *



Parameter Set 2



Set Cable Defaults Current Parameter Set



Set Cable Defaults Both Parameter Sets

AB Spares

IBM Keyboard Wedge (Communication Setup)

This chapter provides the configuration bar codes for the IBM Keyboard Wedge Synapse cables:

- (Catalog No. 2755-HFC-SP1-01)
- (Catalog No. 2755-HFC-SP2-01)

IBM Keyboard Wedge Synapse Cable Defaults

Scan the following bar code to set the IBM Keyboard Wedge Cables to their default values. Defaults are indicated with an asterisk *.



Set PC Wedge Synapse Cable Defaults

Scan this label to set the IBM PC Wedge Synapse cable to the default settings shown below.

Item	Default Setting	Code on Page:
Host	IBM PC/AT IBM PS/2-50, 55SX, 60, 70, 80	4-2
Country	North American	4-3
Bar Codes with Unknown Characters	Send Bar Codes With Unknown Characters	4-4
Intercharacter Delay	5 milliseconds	4-4
Parameter Set	Parameter Set 1	4-5

Scan the bar code symbols for the settings you need to change.

IBM Keyboard Wedge Cable Host



IBM PC / AT *
IBM PS/2-50, 55SX, 60, 70,80



IBM PC / XT



IBM PS/2-30



NCR 7052

AB Spares

IBM Keyboard Wedge Country Selection

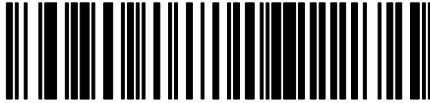

North American *

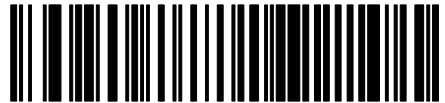

German

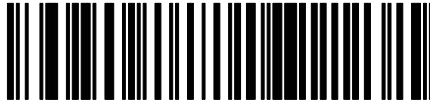

French

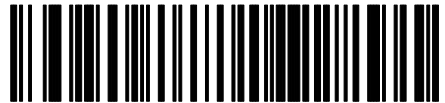

French International



Spanish

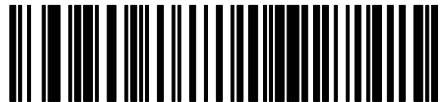

Italian



Swedish



British

IBM Keyboard Wedge Unknown Characters

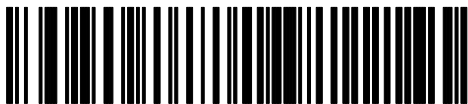

Send Bar Codes with Unknown Characters *



Do Not Send Bar Codes with Unknown Characters

IBM Keyboard Wedge Intercharacter Delay



Short 5 Millisecond Delay *



Medium 50 Millisecond Delay



Long 99 Millisecond Delay

AB Spares

IBM Keyboard Wedge Cable Advanced Features



Parameter Set 1 *

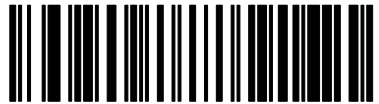

Parameter Set 2



Set Cable Defaults Current Parameter Set



Set Cable Defaults Both Parameter Sets

DEC VT520 Keyboard Wedge (Communications Setup)

This chapter provides the configuration bar codes for the DEC keyboard Synapse cable:

- (Catalog No. 2755-HFC-SV2-01)

DEC VT520 Keyboard Wedge Synapse Cable Defaults

Scan the following bar code to set the IBM Keyboard Wedge Cables to their default values. Defaults are indicated with an asterisk.



Set DEC VT520 Keyboard Wedge Synapse Cable Defaults

Scan this label to set the DEC VT520 Synapse cable to the default settings shown below.

Item	Default Setting	Code on Page:
Host	DEC VT520	5-2
Country	North American	5-2
Bar Codes with Unknown Characters	Send Bar Codes With Unknown Characters	5-4
Intercharacter Delay	5 milliseconds	5-4
Parameter Set	Parameter Set 1	5-5

Scan the bar code symbols for the settings you need to change.

DEC VT520 Wedge Synapse Cable Host



DEC VT520 *



DEC VT520 with PS/2 Keyboard

DEC VT520 Keyboard Wedge Country Selection

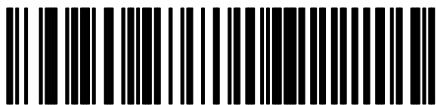

North American *



German



French

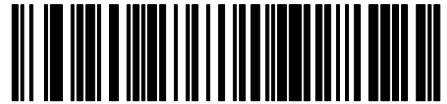

French International



Spanish

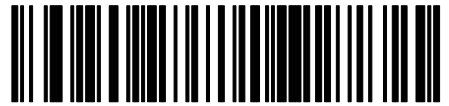

Italian



Swedish



British

AB Spares

DEC VT520 Cable Unknown Characters

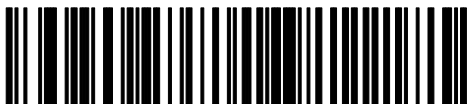

Send Bar Codes with Unknown Characters *



Do Not Send Bar Codes with Unknown Characters

DEC VT520 Keyboard Wedge Intercharacter Delay



Short 5 Millisecond Delay *



Medium 50 Millisecond Delay



Long 99 Millisecond Delay

DEC VT520 Keyboard Wedge Synapse Cable Advanced Features

Scan the following symbols to select the current parameter set and/or set the defaults for each parameter set.

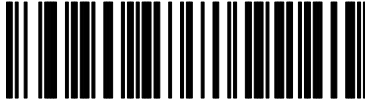

Parameter Set 1 *



Parameter Set 2

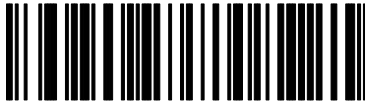

Set Cable Defaults Current Parameter Set

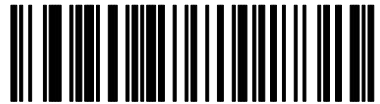

Set Cable Defaults Both Parameter Sets

AB Spares

DEC VT220/320/420 Keyboard Wedge Cable (Communication Setup)

This chapter provides the configuration bar codes for the DEC VT220/320/420 keyboard wedge Synapse cable:

- (Catalog No. 2755-HFC-SV1-01)

DEC VT220/320/420 Keyboard Wedge Interface Cable Defaults

Scan the following bar code to set the DEC VT220/320/420 Keyboard Wedge Cables to their default values. Defaults are indicated with an asterisk *.

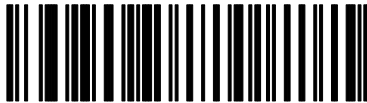

Set DEC VT220/320/420 Wedge Synapse Cable Defaults

Scan this label to set the DEC VT220/320/420 Synapse cable to the default settings shown below.

Item	Default Setting	Code on Page:
Host	DEC VT220 / 320	6-2
Country	North American	6-2
Bar Codes with Unknown Characters	Send Bar Codes With Unknown Characters	6-4
Intercharacter Delay	5 milliseconds	6-4
Parameter Set	Parameter Set 1	6-5

Scan the bar code symbols for the settings you need to change.

DEC VT220 / 320 / 420 Keyboard Wedge Synapse Cable Host



DEC VT220 / 320 *



DEC VT420

DEC VT220 / 320 / 420 Keyboard Wedge Country Selection



North American *



German

AB Spares



French



French International



Spanish



Italian

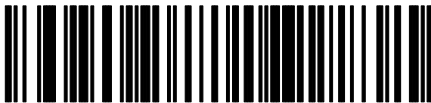

Swedish



British

DEC VT220/320/420 Keyboard Wedge Unknown Characters



Send Bar Codes with Unknown Characters *

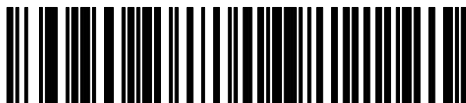

Do Not Send Bar Codes with Unknown Characters

DEC VT220/320/420 Keyboard Wedge Intercharacter Delay



Short 5 Millisecond Delay *



Medium 50 Millisecond Delay



Long 99 Millisecond Delay

AB Spares

DEC VT220/320/420 Keyboard Wedge Advanced Features

Scan the following symbols to select the current parameter set and/or set the defaults for each parameter set.

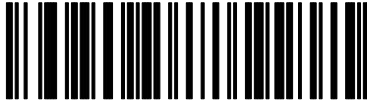

Parameter Set 1 *

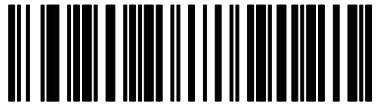

Parameter Set 2



Set Cable Defaults Current Parameter Set



Set Cable Defaults Both Parameter Sets

Scanner Emulation Cable (Communication Setup)

This chapter provides the configuration bar codes for the scanner emulation Synapse cable:

- (Catalog No. 2755-HFC-SA1-01)

Scanner Emulation Synapse Cable Defaults

Scan the following bar code to set the scanner emulation cable to its default values. Defaults are indicated with an asterisk *.

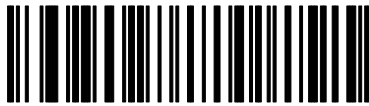

Set Scanner Emulation Cable Defaults

Scan this label to set the Scanner Emulation Synapse cable to the default settings shown below.

Item	Default Setting	Code on Page:
Emulation	Standard	7-2
Leading Margin	80 Millisecond	7-3
Decode LED	Enabled	7-3
Emulation Timeout	3 Seconds	7-4
Polarity	Margin Low / Bar High	7-5
Unknown Characters	Send Bar Codes with Unknown Characters	7-5
Convert All to Code 39	Disabled	7-6
Code 39 to Code 39 Full ASCII	Disabled	7-6
Parameter Set	Parameter Set 1	7-7

Scanner Emulation Host



Standard Wand Emulation *



MSI Wand Emulation

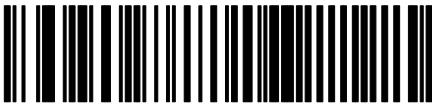

Telxon Wand Emulation



Norand Wand Emulation

Scanner Emulation Variable Leading Margin



80 Millisecond *

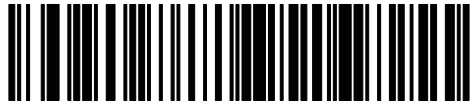

140 Millisecond



200 Millisecond

Scanner Emulation Check for Decode LED



Check for Decode LED *

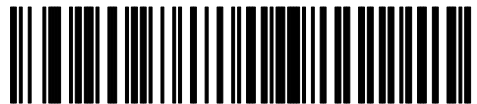

Do Not Check for Decode LED

AB Spares

Scanner Emulation Timeout



3 Second Timeout *



4 Second Timeout



5 Second Timeout

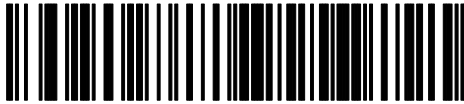

10 Second Timeout



30 Second Timeout

Scanner Emulation Polarity



Margin Low / Bar High *



Margin High / Bar Low

Send Bar Codes with Unknown Characters



Send Bar Codes with Unknown Characters *



Do Not Send Bar Codes with Unknown Characters

AB Spares

Scanner Emulation Convert All to Code 39

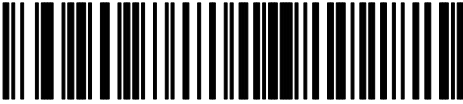

Do Not Convert All to Code 39 *



Convert All to Code 39

Scanner Emulation Code 39 to Code 39 Full ASCII



Do Not Do Not Convert Code 39 to Code 39 Full ASCII *

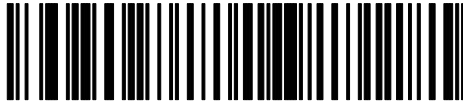

Convert Code 39 to Code 39 Full ASCII

Scanner Emulation Cable Advanced Features

Scan the following symbols to select the current parameter set and/or set the defaults for each parameter set.

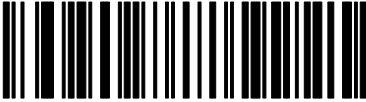

Parameter Set 1 *

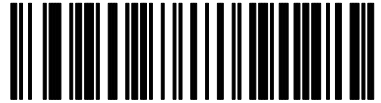

Parameter Set 2

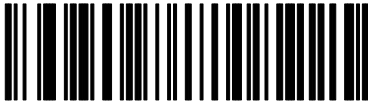

Set Cable Defaults Current Parameter Set

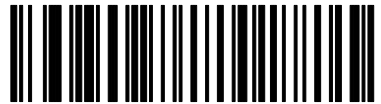

Set Cable Defaults Both Parameter Sets

AB Spares

Enhanced Decoder Application

This appendix describes how to configure and operate the scanner when connected to an Allen-Bradley Enhanced Decoder (Catalog No. 2755-DD/DS).

- using the RS-232 port for output
- using the AUX port for Pass-Through

This section also provides configuration information for an Auxiliary Port Pass Through application for the enhanced decoder.



ATTENTION: Do not install the scanner emulation Synapse cable with power applied to either the Synapse cable or enhanced decoder. Failure to follow this caution may result in damage to the scanner, Synapse cable, or enhanced decoder.

For additional reference you should refer to the following publications:

- DS/DS Enhanced Decoder User Manual (Publication No. 2755-833)
- Gun Adapter Product Data Sheet (Publication No. 2755-2.37)

Enhanced Decoder Application using Scanner Port

Hardware Connections for Scanner Output

The scanner connects to an input port on the Enhanced Decoder with a Scanner Emulation Synapse cable (Catalog No. 2755-HFC-SA1-01) and Gun Adapter (Catalog No. 2755-NC16).

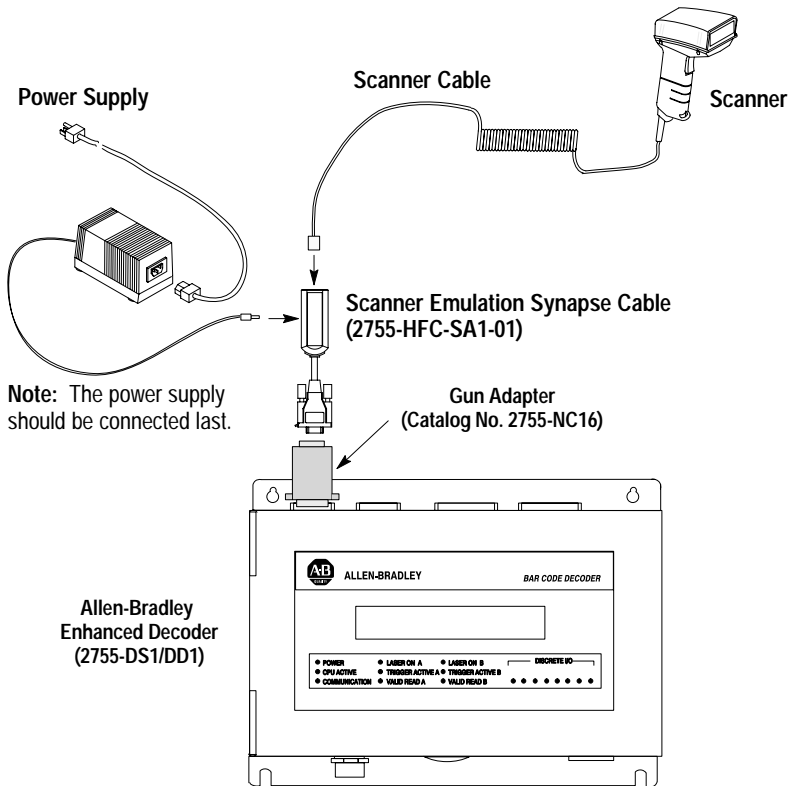

Scanner Configuration for Scanner Emulation Output

You will need to setup the scanner for operation with the cable and configure the cable as described on the next page.

AB Spares

Configuration Codes for Scanner Emulation Output

1. After making the necessary connections, scan the following following bar code symbols to setup the scanner for use with the scanner emulation cable.



Scan this Symbol First
then



Set Scanner for Synapse Cable Operation
then



Enable Synapse Cable Communication

2. Set the scanner emulation cable to defaults by scanning the following:



Set Scanner Cable Defaults

3. The cable defaults will work with the enhanced decoder. Your application may have specific requirements. Chapter 7 lists the settings that can be modified.

Enhanced Decoder Setup for Scanner Input

You will need to configure the Allen-Bradley Enhanced decoder. Refer to the Enhanced Decoder user manual (Publication 2755-833).

1. Set Response Mode = **Immediately After Valid Package**
2. Set Package Detect Input Filter = **Yes**; Sense = **Lo** = **Package**
3. Set Laser On Mode = **Triggered**
4. Set Decode Trigger = **Package Detect**
5. No Read Timer \cong **8000 ms**

AB Spares

Enhanced Decoder Application using AUX Port for Pass Through

Hardware Connections for AUX Port Pass-Through

The scanner connects to an input port on the Enhanced Decoder with a 25-pin RS-232 Synapse cable (Catalog No. 2755-HFC-SR2-01) and a null modem adapter.

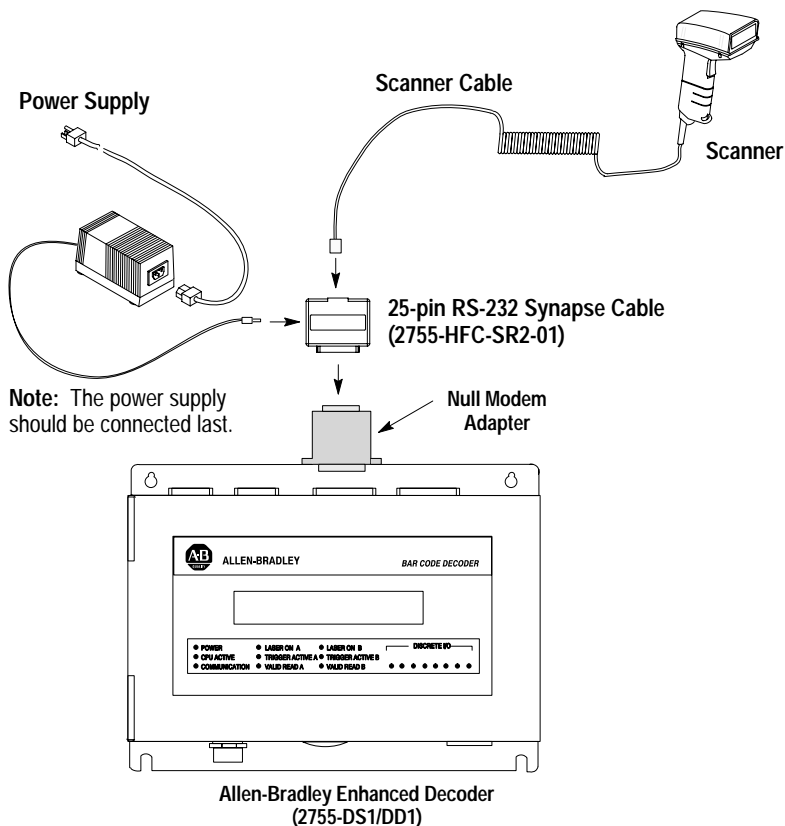

Scanner Configuration for AUX Port Pass-Through

You will need to setup the scanner for operation with the cable and configure the cable as described on the next page.

Configuration Codes for AUX Port Pass Through

1. After making the necessary connections, scan the following following bar code symbols to setup the scanner for use with the scanner emulation cable.

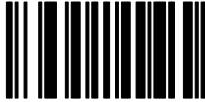

Scan this Symbol First

then



Set Scanner for Synapse Cable Operation



Enable Synapse Cable Communication

2. Scan this symbol to set the default settings for the RS-232 synapse cable.



Set RS-232 Synapse Cable Defaults

3. Set No Parity.

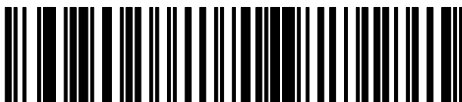

Do Not Check Parity

AB Spares

Enhanced Decoder Setup for AUX Port Pass Through

You will need to configure the Allen-Bradley Enhanced decoder. Refer to the Enhanced Decoder user manual (Publication 2755-833).

- 1.** Select Aux Terminal Data Entry (Screen 8) from the Main Menu.
- 2.** Set Enable Keyboard Entry = **Yes**
- 3.** Save and Exit the configuration.
- 4.** Move internal selector (jumper) to the data entry position on the system board (B-5, B-6).
- 5.** Make sure the hand-held scanner baud rate = **9600**, parity = **None**, data bits = **8**, and stop bits = **1**.
- 6.** See Chapter 13 of Enhanced Decoder user manual (Publication 2755-833) for additional information.

Flexible Interface Module Application

This appendix describes how to configure and operate the scanner when connected to a Flexible Interface Module (Catalog No. 2760-RB).



ATTENTION: Do not install the RS-232 Synapse cable with power applied to either the Synapse cable or Flexible Interface Module. Failure to follow this caution may result in damage to the scanner, Synapse cable, or Flexible Interface Module.

For additional reference you should refer to the following publications:

- Flexible Interface Module User Manual
(Publication No. 2760-ND001)
- SFC1 or SFC2 Protocol Cartridge User Manuals
(Publication No. 2760-ND002 and 2760-822)

Hardware Connections

The scanner connects to one of the three communication ports on the Flexible Interface Module with an RS-232 Synapse cable (Catalog No. 2755-HFC-SR2-01). The interface module requires an SFC2 Protocol Cartridge.

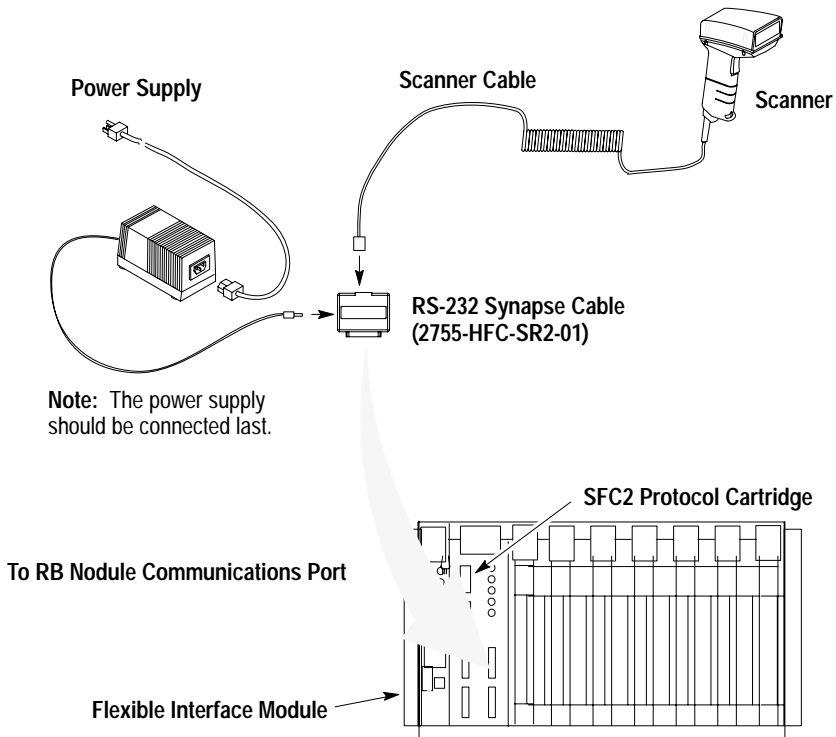

Scanner Configuration

Configure the scanner using the bar codes described in Chapter 1. The Flexible Interface Module does not require any specific scanner configuration. However, you will need to configure the cable communication parameters as described on the next page.

Configuration Codes for Flexible Interface Module Application

7. After making the necessary connections, scan the following following bar code symbols to setup the scanner for use with the scanner emulation cable.



Scan this Symbol First

then



Set Scanner for Synapse Cable Operation



Enable Synapse Cable Communication

8. Set the RS-232 Synapse cable to defaults by scanning the following:



Set RS-232 Synapse Cable Defaults

9. The cable defaults will work with the Flexible Interface Module. Your application may have specific requirements. Chapter 3 lists the settings that can be modified. If you change a communication setting, make sure the Flexible Interface Module is configured to accept the change.

AB Spares

Flexible Interface Module Setup

You will need to configure the Flexible Interface Module. Refer to the user manual for the protocol cartridge and interface module.

- 1.** When configuring the Flexible Interface Module, first select 90B to reset the configuration to factory defaults.
- 2.** Configure screens 3, 21, and 11 (in this order) as shown on the following pages:

2760-RB SERIES A REVISION J
 COPYRIGHT 1989 ALLEN-BRADLEY COMPANY, INC.

1X - CONFIGURATION PARAMETERS	2X - IDENTIFICATION NUMBERS
3 - DEVICE PORT PROTOCOL NAMES	4DM - MATCH CODE ENTRIES
5I - DISCRETE BYTE INPUT ENTRIES	6 - THE DATA MATRIX ENTRIES
7 - THE PASS THROUGH ENTRIES	8 - NON-VOLATILE SCRATCH PAD AREA
9XF - RB MODULE FUNCTIONS	AX - HARDWARE DIAGNOSTICS
BX - SOFTWARE DIAGNOSTICS	C - EXIT CONFIGURATION MODE

WHERE X (0 TO 7) AND D (1 TO 3) ARE PORT NUMBERS WHICH ARE DEFINED BELOW :

0 - RB CMMND PRCSS 2 - SERIAL PORT 2 4 - CONFIG PORT 6 - I/O RACK SLT 1
 1 - SERIAL PORT 1 3 - SERIAL PORT 3 5 - I/O RACK SLT 0 7 - RESERVED

WHERE F (A TO E) ARE FUNCTIONS THAT RB CAN PERFORM WHICH ARE DEFINED BELOW :

A - RESET B - SET DEFAULTS C - FLUSH D - INITIALIZE E - CLEAR DIAGS

WHERE M (A TO T) AND I (A TO H) ARE ENTRY NUMBERS FOR THE SELECTION MADE ABOVE.

ENTER A MAIN MENU SELECTION:

ENTER A MAIN MENU SELECTION: 3

PORT 1 = COPYRIGHT 1989 ALLEN-BRADLEY COMPANY, INC.
 2760-SFC1 DT , SERIES A , REVISION B (YES/NO) = YES.

PORT 2 = COPYRIGHT 1989 ALLEN-BRADLEY COMPANY, INC.
 2760-SFC1 DT , SERIES A , REVISION B (YES/NO) = YES.

PORT 3 = COPYRIGHT 1989 ALLEN-BRADLEY COMPANY, INC.
 2760-SFC1 DT , SERIES A , REVISION B (YES/NO) = YES.

EDIT THIS SELECTION (YES/NO) ?

ENTER A MAIN MENU SELECTION: 21

DUMB TERM. UNSPECIFIED PROTOCOL, 13fh (YES/NO) = YES.

EDIT THIS SELECTION (YES/NO) ?

ENTER A MAIN MENU SELECTION: 11

MODEM CONTROL (ENABLE/DISABLE) = DISABLE.

9600 BITS PER SECOND (YES/NO) = YES.

8 BITS NO PARITY (YES/NO) = YES.

XON/XOFF (ENABLE/DISABLE) = DISABLE.

RS232 (YES/NO) = YES.

RECEIVE MATRIXING (ENABLE/DISABLE) = DISABLE.

BYTE SWAPPING (ENABLE/DISABLE) = ENABLE.

BINARY DATA NO CONVERSIONS (YES/NO) = YES.

HDR/TLR ON OUTPUT (ENABLE/DISABLE) = ENABLE.

HEADER BYTE LENGTH (DEC 0...4) = 0.

HEADER DATA[0] (HEX 0...ff) = 0.

HEADER DATA[1] (HEX 0...ff) = 0.

HEADER DATA[2] (HEX 0...ff) = 0.

HEADER DATA[3] (HEX 0...ff) = 0.

TRAILER BYTE LENGTH (DEC 0...4) = 2.

TRAILER DATA[0] (HEX 0...ff) = a.

TRAILER DATA[1] (HEX 0...ff) = d.

TRAILER DATA[2] (HEX 0...ff) = 0.

TRAILER DATA[3] (HEX 0...ff) = 0.

MAX DATA BYTE LENGTH (DEC 0...124) = 0.

MIN DATA BYTE LENGTH (DEC 0...124) = 0.

CONTINUE THIS SELECTION (YES/NO) ?

3. Make sure PLC program is written to access Flexible Interface Module data.

SLC 5/03, 5/04 Controller Application

This appendix describes how to configure and operate the scanner when connected to an SLC 5/03, 5/04 controller.



ATTENTION: Do not install the RS-232 Synapse cable with power applied to either the Synapse cable or SLC controller. Failure to follow this caution may result in damage to the scanner, Synapse cable, or SLC.

For additional reference you should refer to the following publications:

- Advanced Programming Software (APS) User Manual
- Advanced Programming Software (APS) Reference Manual

Hardware Connections

The scanner connects to the Channel 0 port of the SLC with an RS-232 Synapse cable (Catalog No. 2755-HFC-SR2-01).

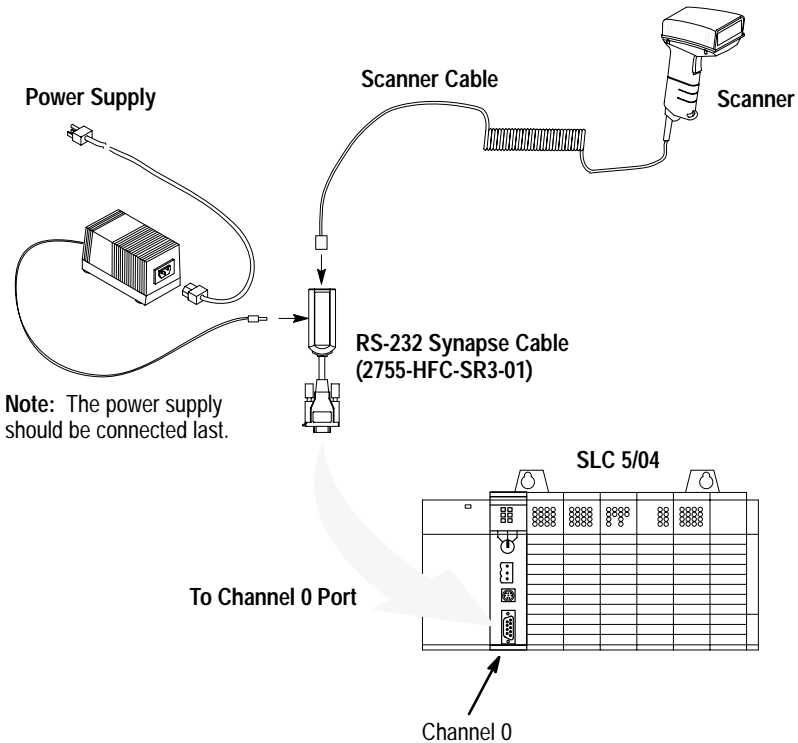

Scanner Configuration

Configure the scanner using the bar codes described in Chapter 1. The SLC controller does not require any specific scanner configuration. However, you will need to configure the cable communication parameters as described on the next page.

Configuration Codes for SLC Application

1. After making the necessary connections, scan the following symbols to set up the scanner for use with the scanner emulation cable.

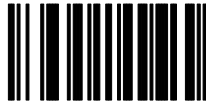

Scan this Symbol First
then



Set Scanner for Synapse Cable Operation
then



Enable Synapse Cable Communication

2. Set the bar code suffix to CR LF (ASCII equivalent 7013) by scanning the following labels.



Suffix



7



0



1



3

3. Send the data then the suffix by scanning this label.

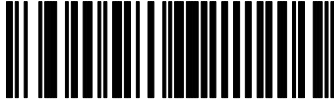

Send Data then Suffix

4. Set the RS-232 Synapse cable to defaults by scanning the following:

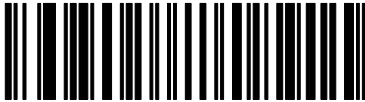

Set RS-232 Synapse Cable Defaults

5. The cable defaults will work with the SLC 5/03, 5/04. Your application may have specific requirements. Chapter 3 lists the settings that can be modified. If you change a communication setting, make sure the SLC controller is configured to accept the change.

SLC 5/03, 5/04 Setup

You will need to configure the SLC, refer to the user manuals and following instructions:

1. Set the SLC Channel 0 to **User** in the Channel 0 Configuration screen

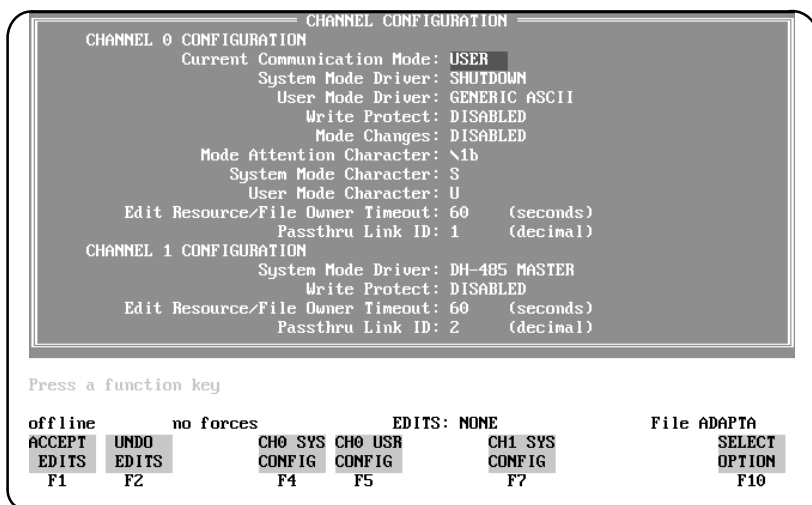

2. Configure Channel 0 in the Channel 0 User Mode Configuration screen.

CHANNEL 0 USER MODE CONFIGURATION			
Communication Driver:	GENERIC ASCII		
Diagnostic File:	Reserved		
Baud Rate:	9600	Parity:	NONE
Stop Bits:	1	Data Bits:	8
Delete Mode:	IGNORE	RTS Off Delay [x20 ms]:	0
Echo:	DISABLED	RTS Send Delay [x20 ms]:	0
Control Line: NO HANDSHAKING		XON/XOFF:	DISABLED
Termination 1:	\a	Append 1:	\f
Termination 2:	\d	Append 2:	\f

Press a function key

offline	no forces	EDITS: NONE	File ADAPTA
ACCEPT	UNDO		CHANNEL SELECT
EDITS	EDITS		STATUS OPTION
F1	F2		F9 F10

Note that Termination 1 is set for **\a** or Line Feed [**LF**], and Termination 2 is set for **\d** or Carriage Return [**CR**]. These terminators, along with the **ARL** instruction in the SLC, allow you to read one message at a time with [**CR**] [**LF**] terminators.

SLC Program

The sample ladder logic listing below instructs the SLC 5/03 or 5/04 to:

Rung 2:0 – Read one string of ASCII data terminated with a **[CR] [LF]**.

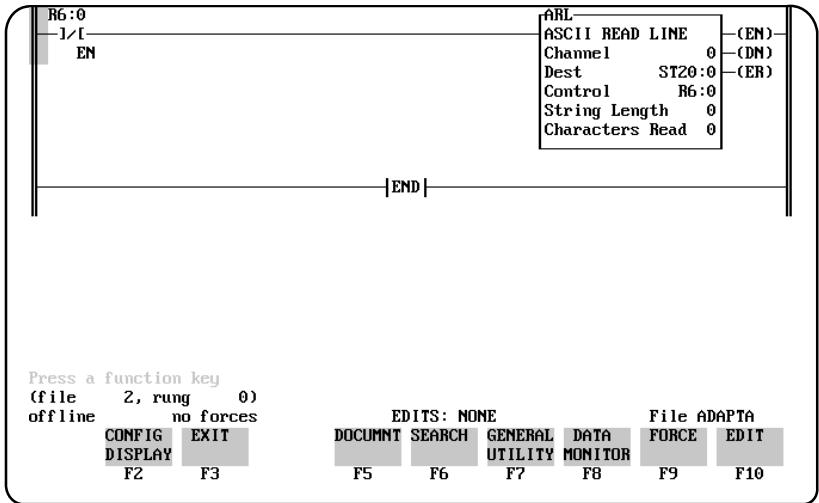

Refer to the SLC 5/03 user manual for detailed information on using the SLC 5/03 or 5/04 programming software.

PLC-5 Controller Application

This appendix describes how to configure and operate the scanner when connected to a PLC-5 controller.



ATTENTION: Do not install the RS-232 Synapse cable with power applied to either the Synapse cable or PLC controller. Failure to follow this caution may result in damage to the scanner, Synapse cable, or PLC.

For additional reference you should refer to the following publications:

- PLC-5 User Manual
- 6200 Series Programming Software User Manual

Hardware Connections

The scanner connects to the Channel 0 port of the PLC with an RS-232 Synapse cable (Catalog No. 2755-HFC-SR2-01). The connections are shown in the scanner user manual (Publication 2755-6.2).

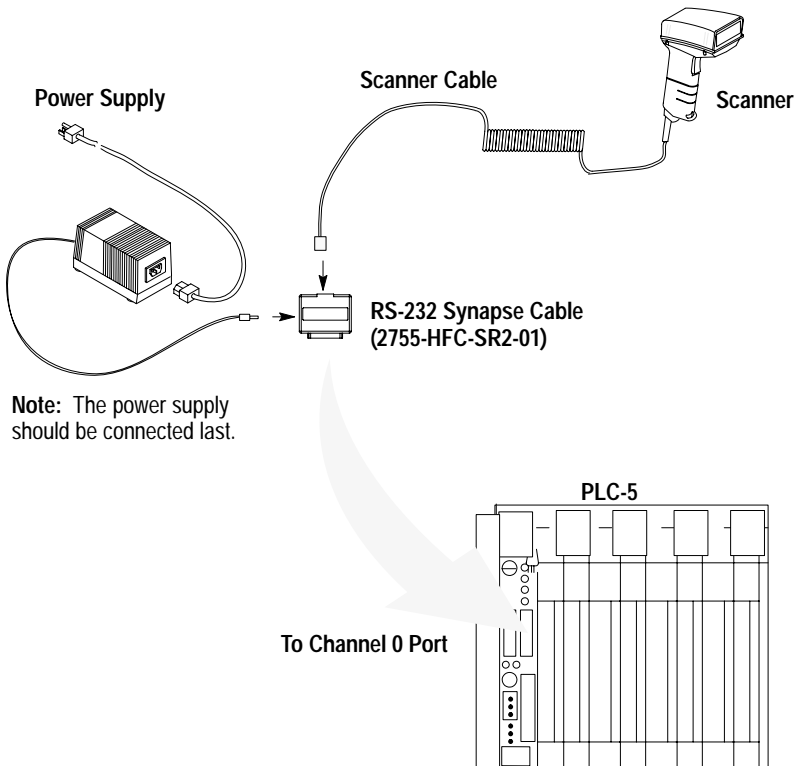

Scanner Configuration

Configure the scanner using the bar codes described in Chapter 1. The PLC controller does not require any specific scanner configuration. However, you will need to configure the cable communication parameters as described on the next page.

Configuration Codes for PLC Application

1. After making the necessary connections, scan the following following bar code symbols to setup the scanner for use with the scanner emulation cable.



Scan this Symbol First
then



Set Scanner for Synapse Cable Operation

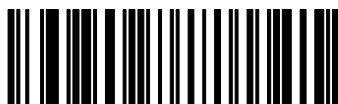

Enable Synapse Cable Communication

2. Set the bar code suffix to CR LF (ASCII equivalent 7013) by scanning the following labels.

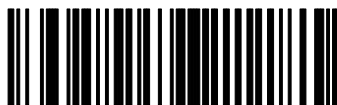

Suffix



7



0



1



3

3. Send the data then the suffix by scanning this label.

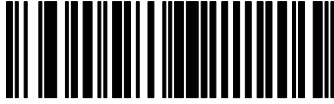

Send Data then Suffix

4. Set the RS-232 Synapse cable to defaults by scanning this label.

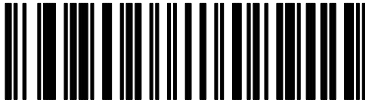

Set RS-232 Synapse Cable Defaults

5. The cable defaults will work with the PLC-5. Your application may have specific requirements. Chapter 3 lists the settings that can be modified. If you change a communication setting, make sure the PLC controller is configured to accept the change.

AB Spares

PLC-5 Setup

You will need to configure the Channel 0 port of the PLC-5. Refer to the 6200 Series Programming Software user manual and the following instructions.

1. Set the PLC-5 Channel 0 to **User** in the Channel 0 Configuration screen.

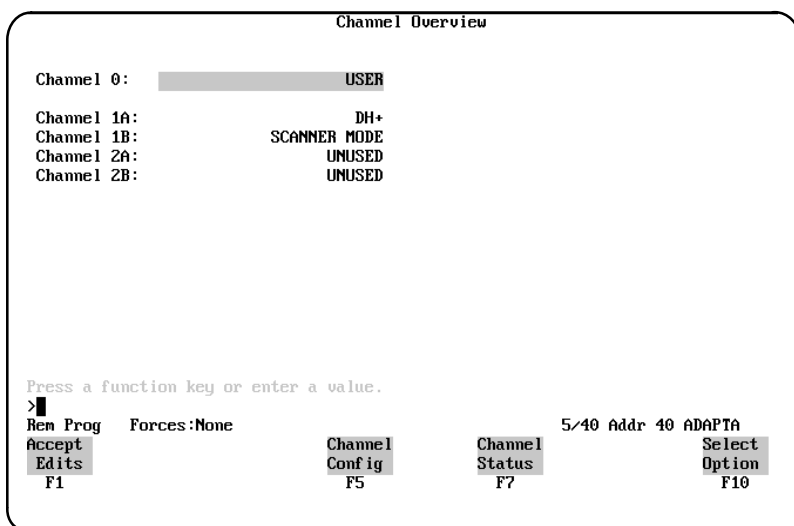

2. Configure Channel 0 in the User Mode Channel 0 Configuration screen.

```

User Mode
Channel 0 Configuration

Diag. file:      N21          XON/XOFF:      DISABLED
Remote mode change: DISABLED  System mode char.: S
Mode attention char.: \0x1b   User mode char.: U

Baud rate:      9600         Parity:         NONE
Stop bits:      1           Bits per character: 8
Control line:   NO HANDSHAKING

Echo/delete mode: DISABLED   RTS send delay (20 ms): 0
RTS off delay (20 ms): 0

Termination 1:  \0xd         Append 1:      \0xf
Termination 2:  \0xa         Append 2:      \0xf

Press a function key or enter a value.
>
Rem Prog Forces:None          5/40 File ADAPTA
Accept Chan 0 Select
Edits Status Option
F1 F9 F10

```

Note that Termination 1 is set for **\0xa** or Line Feed [**LF**], and Termination 2 is set for **\0xd** or Carriage Return [**CR**]. These terminators, along with the **ARL** instruction in the PLC-5, allow you to read one message at a time with [**CR**] [**LF**] terminators.

AB Spares

PLC Program

The sample ladder logic listing below instructs the PLC-5 to:

Rung 2:0 – Read one string of ASCII data terminated with a **[CR] [LF]**.

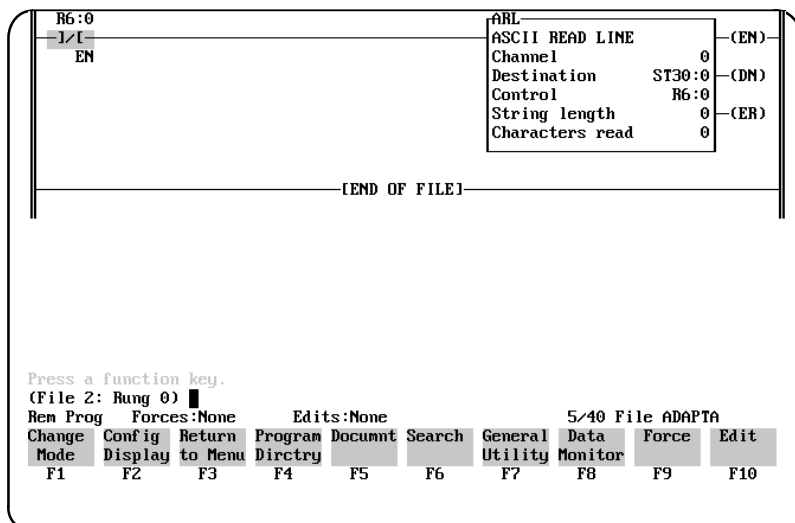

Refer to the PLC-5 user manual for detailed information on using the PLC programming software.

AdaptaScan Pass Through Application

This appendix describes how to configure and operate the scanner when connected to an AdaptaScan Bar Code Reader.

Hardware Connections

The scanner connects to the AdaptaScan wiring base with a custom cable connected to the AdaptaScan Pass Through cable (Catalog No. 2755-HDC-GA2-08). The cables and connections are shown in Chapter 2 of the scanner user manual (Publication 2755-6.2).

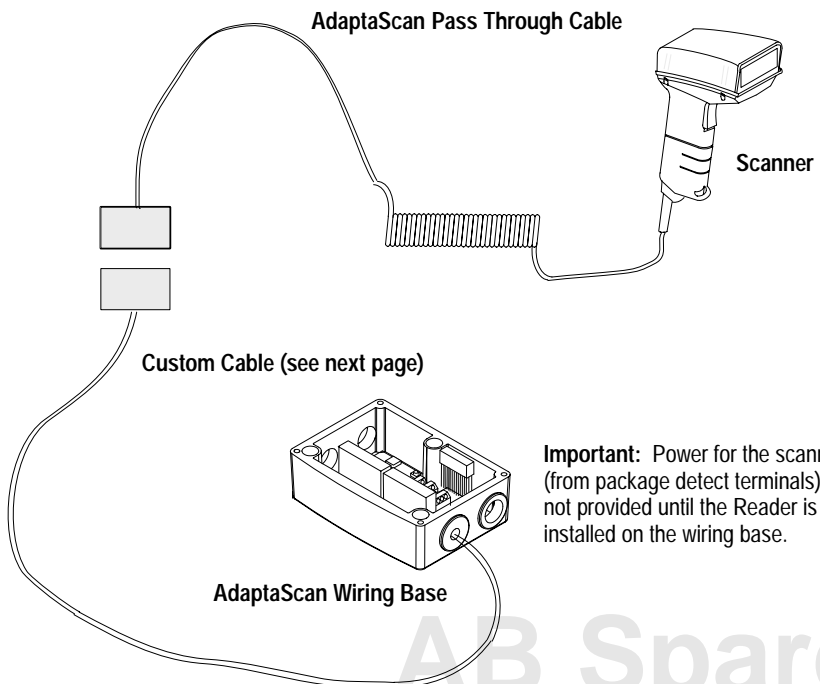

AB Spares

The custom cable for the AdaptaScan Pass Through cable connects to the RS-232 and package detect terminals in the AdaptaScan wiring base.

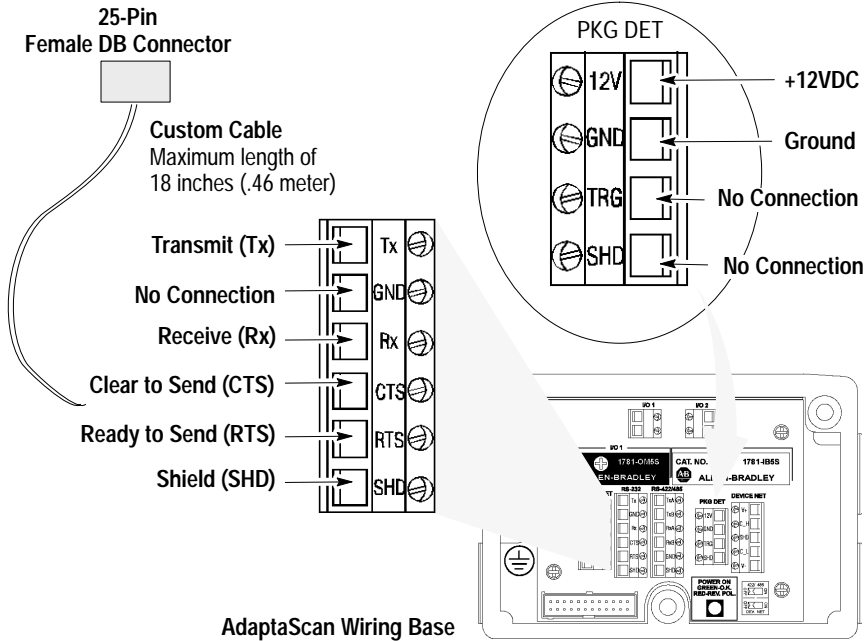

The following table provides the pinout connections for the cable (DB 25-pin female connector).

Pass Through Cable Pin Number	Function	AdaptaScan Terminal Connection
2	Receive Data Input	Tx (RS-232 Terminal Block)
3	Transmit Data Output	Rx (RS-232 Terminal Block)
4	CTS Input	RTS (RS-232 Terminal Block)
5	RTS Output	CTS (RS-232 Terminal Block)
7	Ground	GND (Package Detect Terminal Block)
9	+V 4.8 to 14.0V DC	12V (Package Detect Terminal Block)
Shield	Shield Ground	SHD (RS-232 Terminal Block)

Configuration Codes for AdaptaScan Pass Through Application

1. After making the necessary connections, scan the following following bar code symbols to setup the scanner for use with the scanner emulation cable.



Scan this Symbol First
then



Set Scanner for AdaptaScan Pass Through Cable Operation

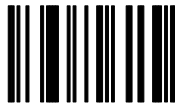

Enable AdaptaScan Pass Through Cable Communications

2. Set No Parity.



Do Not Check Parity

3. Set 8 Data Bits.



8 Data Bits

AB Spares

4. Set 1 Stop Bit.



1 Stop Bit

5. The cable will now work with the AdaptaScan default communication settings. Your application may have specific requirements. Chapter 8 lists the settings that can be modified. If you change a communication setting, make sure the AdaptaScan RS-232 port is configured to accept the change.

AdaptaScan Setup

You may need to configure the AdaptaScan RS-232 port to accept the scanner data. Refer to the AdaptaScan Reader Programming Software user manual. Verify that the AdaptaScan serial port is configured as shown below. All settings use the default values except for the Enable Pass-Through to DeviceNet check box.

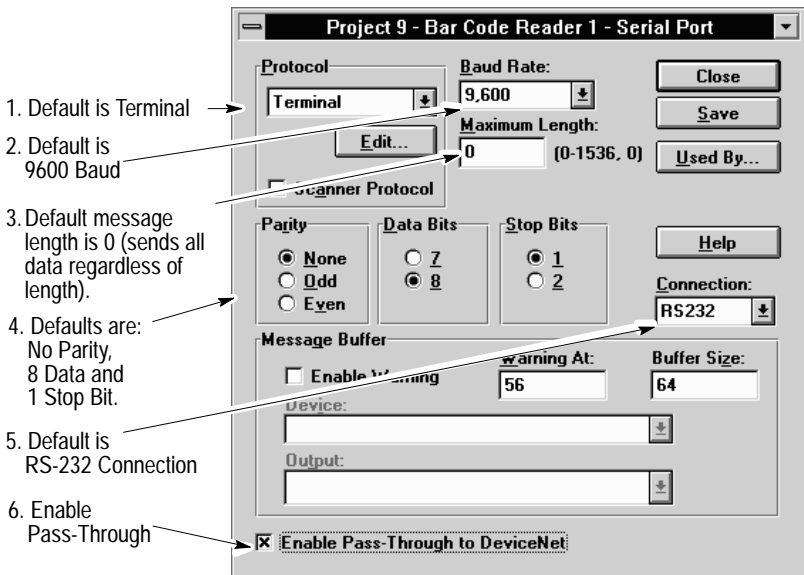

DTAM™ Plus DeviceNet™ Application

This appendix describes how to configure and operate the scanner when connected to a DTAM Plus Operator Interface on a DeviceNet network.

Related Publications

Below is a list of related publications you may need to refer to when using the DTAM Plus Operator Interface.

Publication No.	Title
2707-800	DTAM Plus Operator Interface Module User Manual
2707-800.5	DTAM Plus DeviceNet Operator Interface Document Update
2707-801	DTAM Programming Software Programming Manual
2707-802	Getting Started with DTAM Plus User Manual

Hardware Connections

The scanner connects to the DTAM Plus with the 9-Pin RS-232 Synapse cable (Catalog No. 2755-HFC-SR3-01). The cables and connections are shown in Chapter 2 of the scanner user manual (Publication 2755-6.2).

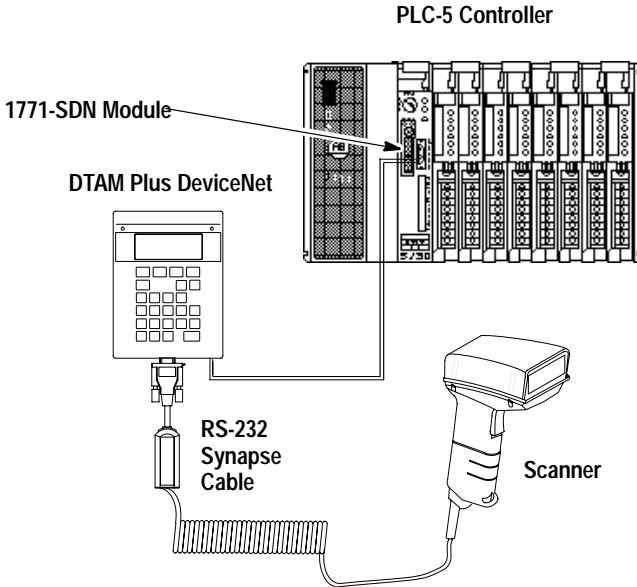

AB Spares

Codes for DTAM Plus Operator Interface DeviceNet Application

1. After making the necessary connections, scan the following following bar code symbols to setup the scanner for use with the scanner emulation cable.



Scan this Symbol First
then



Set Scanner for Synapse Cable Operation

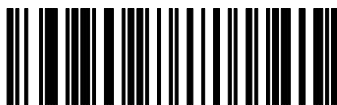

Enable Synapse Cable Communication

2. Set the bar code suffix to CR LF (ASCII equivalent 7013) by scanning the following labels.

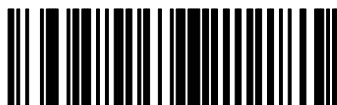

Suffix



7



0



1



3

3. Send the data then the suffix by scanning this label.



Send Data then Suffix

4. Set the RS-232 Synapse cable to defaults by scanning this label.



Set RS-232 Synapse Cable Defaults

5. The cable defaults will work with the DTAM Plus. Your application may have specific requirements. Chapter 3 lists the settings that can be modified. If you change a communication setting, make sure the PLC controller is configured to accept the change.

AB Spares

DTAM Plus Operator Interface Setup

You may need to configure the DTAM Plus Operator Interface RS-232 port to accept the scanner data. Refer to the *DTAM Programming Software Programming Manual*. Configure the DTAM Plus Operator Interface serial port as shown below.

1. Open Screen Builder.
2. Open Create Screen.
3. Open Data Entry Screen.
4. Select Set Up Screen.
5. Select Data Entry.
6. Select ASCII Input.
7. Set up DTAM.

DeviceNet Operation

The DTAM Plus DeviceNet operates as a Group 2 Server on the DeviceNet network. It supports the Unconnected Message Manager (UCMM). The DTAM Plus DeviceNet implements the predefined master/slave connection set, operating as a slave device. It does not initiate communications except for a Duplicate Node Address check on power-up.

The DTAM Plus DeviceNet supports the polled I/O method of exchanging data with a master, in the following sequence:

1. The designated master writes an output image to the DTAM Plus DeviceNet using the Poll Command message.
2. The DTAM Plus DeviceNet responds to the poll command by returning an input image back to the master in a Poll Response message.

Note: The size of the input and output images (also referred to as files) are individually configurable from 0 words to 121 words each, to optimize DeviceNet network loading.

3. The DTAM Plus DeviceNet application program interacts with data contained in the input and output files.
4. Data Display screens are used to view input and output data.
5. Data Entry screens are used to modify input and output data from the scanner.

AB Spares

ASCII Chart

ASCII Value	Full ASCII Code 39 Encode Char.	Character (Control Code)	ASCII Value	Full ASCII Code 39 Encode Char.	Character (Control Code)
1000	%U	NULL (CTRL 2)	1016	\$P	DLE (CTRL P)
1001	\$A	SOH (CTRL A)	1017	\$Q	DC1 (CTRL Q)
1002	\$B	STX (CTRL B)	1018	\$R	DC2 (CTRL R)
1003	\$C	ETX (CTRL C)	1019	\$S	DC3 (CTRL S)
1004	\$D	EOT (CTRL D)	1020	\$T	DC4 (CTRL T)
1005	\$E	ENQ (CTRL E)	1021	\$U	NAK (CTRL U)
1006	\$F	ACK (CTRL F)	1022	\$V	SYN (CTRL V)
1007	\$G	BEL (CTRL G)	1023	\$W	ETB (CTRL W)
1008	\$H	BS (CTRL H)	1024	\$X	CAN (CTRL X)
1009	\$I	HT (CTRL I)	1025	\$Y	EM (CTRL Y)
1010	\$J	LF (CTRL J)	1026	\$Z	SUB (CTRL Z)
1011	\$K	VT (CTRL K)	1027	%A	ESC (CTRL)
1012	\$L	FF (CTRL L)	1028	%B	FS (CTRL \)
1013	\$M	CR (CTRL M)	1029	%C	GS (CTRL])
1014	\$N	SO (CTRL N)	1030	%D	RS (CTRL ^)
1015	\$O	SI (CTRL O)	1031	%E	US (CTRL _)

ASCII Value	Full ASCII Code 39 Encode Char.	Character	ASCII Value	Full ASCII Code 39 Encode Char.	Character
1032	SP	SP	1057	9	9
1033	/A	!	1058	/Z	:
1034	/B	'	1059	%F	;
1035	/C	#	1060	%G	<
1036	/D	\$	1061	%H	=
1037	/E	%	1062	%I	>
1038	/F	&	1063	%J	?
1039	/G	'	1064	%V	@
1040	/H	(1065	A	A
1041	/I)	1066	B	A
1042	/J	*	1067	C	C
1043	/K	+	1068	D	D
1044	/L	,	1069	E	E
1045	-	-	1070	F	F
1046	.	.	1071	G	G
1047	/	/	1072	H	H
1048	0	0	1073	I	I
1049	1	1	1074	J	J
1050	2	2	1075	K	K
1051	3	3	1076	L	L
1052	4	4	1077	M	M
1053	5	5	1078	N	N
1054	6	6	1079	O	O
1055	7	7	1080	P	P
1056	8	8	1081	Q	Q

ASCII Value	Full ASCII Code 39 Encode Char.	Character	ASCII Value	Full ASCII Code 39 Encode Char.	Character
1082	R	R	1105	+I	i
1083	S	S	1106	+J	j
1084	T	T	1107	+K	k
1085	U	U	1108	+L	l
1086	V	V	1109	+M	m
1087	W	W	1110	+N	n
1088	X	X	1111	+O	o
1089	Y	Y	1112	+P	p
1090	Z	Z	1113	+Q	q
1091	%K	[1114	+R	r
1092	%L	\	1115	+S	s
1093	%M]	1116	+T	t
1094	%N	^	1117	+U	u
1095	%O	_	1118	+V	v
1096	%W	'	1119	+W	w
1097	+A	a	1120	+X	x
1098	+B	b	1121	+Y	y
1099	+C	c	1122	+Z	z
1100	+D	d	1123	%P	{
1101	+E	e	1124	%Q	
1102	+F	f	1125	%R	}
1103	+G	g	1126	%S	~
1104	+H	h	1127		Undefined

ALT Key Values

ALT Key Value	Keystroke	ALT Key Value	Keystroke	ALT Key Value	Keystroke
2064	ALT 2	2075	ALT K	2086	ALT V
2065	ALT A	2076	ALT L	2087	ALT W
2066	ALT B	2077	ALT M	2088	ALT X
2067	ALT C	2078	ALT N	2089	ALT Y
2068	ALT D	2079	ALT O	2090	ALT Z
2069	ALT E	2080	ALT P	2091	ALT [
2070	ALT F	2081	ALT Q	2092	ALT \
2071	ALT G	2082	ALT R	2093	ALT]
2072	ALT H	2083	ALT S	2094	ALT 6
2073	ALT I	2084	ALT T	2095	ALT -
2074	ALT J	2085	ALT U		

Miscellaneous Key Values

Misc. Key Value	Keystroke	Misc. Key Value	Keystroke	Misc. Key Value	Keystroke
3001	PA 1	3009	CMD 7	3017	
3002	PA 2	3010	CMD 8	3018	1/2
3003	CMD 1	3011	CMD 9	3019	
3004	CMD 2	3012	CMD 10	3020	
3005	CMD 3	3013		3021	
3006	CMD 4	3014		3022	0/00
3007	CMD 5	3015			
3008	CMD 6	3016	-		

AB Spares

Numeric Key Values

Numeric Key Value	Keystroke	Numeric Key Value	Keystroke	Numeric Key Value	Keystroke
6042	*	6049	1	6056	8
6043	+	6050	2	6057	9
6044	Undefined	6051	3	6058	Enter
6045	-	6052	4	6059	Num Lock
6046	.	6053	5	6060	00
6047	/	6054	6		
6048	0	6055	7		

Extended Keyapd Key Values

Numeric Key Value	Keystroke	Numeric Key Value	Keystroke	Numeric Key Value	Keystroke
7001	Break	7008	Backspace	7015	Up Arrow
7002	Delete	7009	Tab	7016	Down Arrow
7003	Page Up	7010	Print Screen	7017	Left Arrow
7004	End	7011	Insert	7018	Right Arrow
7005	Page Down	7012	Home	7019	Back Tab
7006	Pause	7013	Enter		
7007	Scroll Lock	7014	Escape		

TEST SYMBOLS

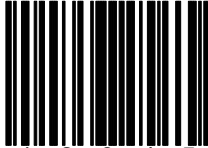

1 2 3 4 5

Code 128

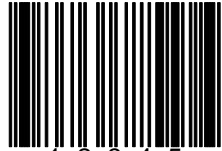

1 2 3 4 5

Code 93

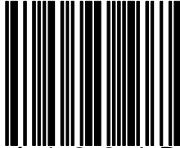

A 1 2 3 4 B

Codabar

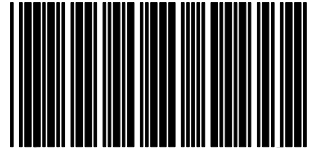

A 1 2 3 4 B

Code 39

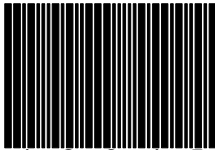

1 2 3 4 5

Discrete 2 of 5

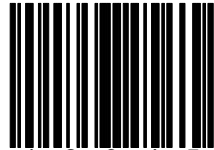

1 2 3 4 5

EAN 128



1 2 3 4 5 6 7 8 9 10 19

EAN 13



1 2 3 4 5 6 7 8

EAN 8

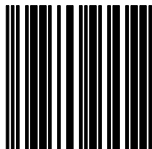

0 1 2 3 4 5

Interleaved 2 of 5



1 2 3 4 5 6 7 8 9 0 1 2

UPC A

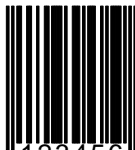

0 1 2 3 4 5 6 5

UPC E

AB Spares

Synapse™ is a trademark of Symbol Technologies Inc.
AdaptaScan™ is a trademark of Allen-Bradley

 **Rockwell** Automation

Allen-Bradley

Worldwide representation.



Argentina • Australia • Austria • Bahrain • Belgium • Brazil • Bulgaria • Canada • Chile • China, PRC • Colombia • Costa Rica • Croatia • Cyprus • Czech Republic • Denmark • Ecuador • Egypt • El Salvador • Finland • France • Germany • Greece • Guatemala • Honduras • Hong Kong • Hungary • Iceland • India • Indonesia • Ireland • Israel • Italy • Jamaica • Japan • Jordan • Korea • Kuwait • Lebanon • Malaysia • Mexico • Netherlands • New Zealand • Norway • Pakistan • Peru • Philippines • Poland • Portugal • Puerto Rico • Qatar • Romania • Russia-CIS • Saudi Arabia • Singapore • Slovakia • Slovenia • South Africa, Republic • Spain • Sweden • Switzerland • Taiwan • Thailand • Turkey • United Arab Emirates • United Kingdom • United States • Uruguay • Venezuela • Yugoslavia

Allen-Bradley Headquarters, 1201 South Second Street, Milwaukee, WI 53204 USA, Tel: (1) 414 382-2000 Fax: (1) 414 382-4444