



Allen-Bradley

***Hand-Held
Cordless Bar
Code Scanners***

***(Cat. Nos.
2755-HCG-4 and
2755-HCG-7)***

Programming Guide

A large, stylized background graphic in shades of gray. It features a globe in the center, with a hand holding a cordless bar code scanner over it. In the background, there are silhouettes of industrial buildings and a large gear. The overall theme is industrial automation and global connectivity.

AB PLCs

Important User Information

The illustrations, charts, sample programs and layout examples shown in this guide are intended solely for purposes of example. Since there are many variables and requirements associated with any particular installation, Allen-Bradley does not assume responsibility or liability (to include intellectual property liability) for actual use based upon the examples shown in this publication.

Allen-Bradley publication SGI-1.1, *Safety Guidelines for the Application, Installation, and Maintenance of Solid-State Control* (available from your local Allen-Bradley office), describes some important differences between solid-state equipment and electromechanical devices that should be taken into consideration when applying products such as those described in this publication.

Reproduction of the contents of this copyrighted publication, in whole or in part, without written permission of Allen-Bradley Company, Inc., is prohibited.

Throughout this manual we use notes to make you aware of safety considerations:



ATTENTION: Identifies information about practices or circumstances that can lead to personal injury or death, property damage or economic loss.

Attention statements help you to:

- identify a hazard
- avoid the hazard
- recognize the consequences

SLC 5/03, SLC 5/04, AdaptaScan, MicroLogix, and DTAM are trademarks of Allen-Bradley Company, Inc.

PLC-5 is a registered trademark of Allen-Bradley Company, Inc.

DeviceNet is a trademark of the open DeviceNet Vendor Association

Table of Contents

Preface

Intended Audience	P-1
Contents of this Manual	P-1
Related Publications	P-2
Configuration Bar Codes	P-2

Chapter 1 Basic Bar Codes

Set Defaults	1-4
Host Interface Code	1-7
Code Types	1-7
Code Lengths	1-10
Decode Options	1-15
UPC-A Preamble	1-20
UPC-E Preamble	1-20
Pause Duration	1-21
Prefix and Suffix	1-23
Data Transmission Formats	1-25
Laser Control	1-27
Baud Rate	1-29
Parity	1-30
Check Parity	1-31
Hardware Handshaking	1-31
Software Handshaking	1-32
Serial Response Time-Out	1-33
Stop Bit Select	1-34
ASCII Format	1-35
RTS Line State	1-35
Intercharacter Delay	1-36

Transmit Code ID Character	1-37
Transmit AIM Code ID	1-38
Ignore Unknown Characters	1-38
International Keyboard Emulation	1-39
International Keyboard Emulation Fast Transmit	1-39
National keyboard Types	1-40
Set Transmission Frequency	1-41
Wait for Host Interface Response Time	1-43

Chapter 2 Advanced Data Format Bar Codes

ADF Overview	2-1
Criteria	2-2
Actions	2-3
Rules Hierarchy	2-3
Criteria	2-4
Special Commands	2-10
Actions	2-11
Numeric Keypad	2-52
Alphanumeric Keypad	2-54

Appendix A Application Examples

Enhanced Decoder	A-2
Hardware Connections for AUX Port Pass-Through	A-3
Configuration Codes for the AUX Port Pass-Through	A-4
Enhanced Decoder Setup for the AUX Port Pass-Through	A-5
Flexible Interface Module	A-6
Hardware Connections for the Flexible Interface Module	A-7
Configuration Codes for the Flexible Interface Module	A-8
Flexible Interface Module Setup	A-9
SLC 5/03 and SLC 5/04 Controllers	A-12
Hardware Connections for the SLC 5/03 and SLC 5/04 Controllers	A-13

Configuration Codes for the SLC 5/03 and SLC 5/04 Controllers	A-14
SLC 5/03 and SLC 5/04 Controllers Setup	A-17
SLC Program	A-19
PLC-5 Controllers	A-20
Hardware Connections for the PLC-5 Controllers	A-21
Configuration Codes for the PLC-5 Controllers	A-22
PLC-5 Controllers Setup	A-25
PLC Program	A-27
AdaptaScan Pass-Through	A-28
Hardware Connections for the AdaptaScan Bar Code Reader	A-29
Configuration Codes for the AdaptaScan Bar Code Readers	A-31
AdaptaScan Bar Code Readers Setup	A-33
DTAM Plus DeviceNet	A-34
Hardware Connections for the DTAM Plus Operator Interface	A-35
Configuration Codes for the DTAM Plus Operator Interface	A-36
DTAM Plus Operator Interface Setup	A-38
DeviceNet Operation	A-39

Appendix B ASCII Table

ASCII Key Values	B-2
ALT Key Values	B-5
Miscellaneous Key Values	B-5
PF Key Values	B-6
F Key Values	B-6
Numeric Key Values	B-7
Extended Keypad Key Values	B-7

Read this preface to familiarize yourself with the rest of the manual. This preface covers the following topics:

- intended audience
- contents of this manual
- related publications
- configuration bar codes

Intended Audience

No special knowledge is required to understand this document or use of the scanner. Cordless scanners may be used with a variety of host devices. You should be familiar with the host's communication ports.

Contents of this Manual

The following table briefly describes the contents of each section.

Chapter	Title	Contents
Preface		Describes the purpose, background, and scope of this manual. Also provides a list of related publications.
1	Basic Bar Codes	Provides the basic bar codes that can be used with the scanners.
2	Advanced Data Format Bar Codes	Provides the advanced bar codes that can be used with the scanners.
Appendix A	Application Examples	Provides examples on using the standard and long range hand-held cordless bar code scanners.
Appendix B	ASCII Table	Lists ASCII conversion chart including Code 39 Full ASCII encoded characters.

Related Publications

Below is a list of related publications you may need to refer to when using the cordless scanners.

Publication No.	Title
2755-6.3	Hand-Held Cordless Bar Code Scanners User Manual
2755-921	Bar Code Basics

Configuration Bar Codes

The configuration bar code symbols are Code 128. The scanner is always enabled to read Code 128 bar codes. Default settings are indicated by an asterisk*. Refer to the example below.

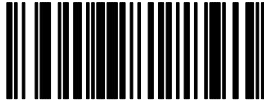

9600*

AB PLCs

Basic Bar Codes

This chapter lists the basic bar codes you can use with the standard and long range scanners (Catalog Nos. 2755-HCG-4 and 2755-HCG-7). The table starting below lists the bar codes or bar code categories found within this chapter.

Parameter	Page Location
Set Defaults	1-4
Host Interface	1-7
Code Types	1-7
Code Lengths	
Code 39	1-10
Code 128	1-11
Codabar	1-11
I 2 of 5	1-11
D 2 of 5	1-12
MSI Plessey	1-13
Decode Options	
Transmit UPC-A Check Digit	1-15
Transmit UPC-E Check Digit	1-15
Convert UPC-E to UPC-A	1-16
EAN Zero Extend	1-16
Transmit No Decode Message	1-17
Decode UPC/EAN Supplemental	1-16
ITF-14/EAN-13 Conversion	1-17

Table continued on the next page.

Parameter	Page Location
Transmit Code 39 Check Digit	1-17
MSI Plessey Check Digit	1-15
Buffer Code 39	1-17
Beeper Volume	1-18
Beep After Good Decode	1-18
UPC/EAN Security Level	1-19
Decode Redundancy	1-19
UPC-A Preamble	1-20
UPC-E Preamble	1-20
Pause Duration	1-21
Prefix/Suffix Values	1-23
Scan Data Transmission Format	1-25
Laser Control	
Laser On Time-Out	1-27
RS-232C Options	
Baud Rate	1-29
Parity	1-30
Check Parity	1-31
Hardware Handshaking	1-31
Software Handshaking	1-32
Serial Response Time-Out	1-33
Stop Bit Select	1-34
ASCII Data Format	1-35
RTS Line State	1-35
Intercharacter Delay	1-36
Transmit Code ID Character	1-37
Transmit AIM Code ID	1-38

Table continued on the next page.

Parameter	Page Location
Ignore Unknown Characters	1-38
International Keypad Emulation	1-39
International Keypad Emulation Fast Xmit	1-39
National Keyboard Types	1-40
Set Transmission Frequency (Channel)	1-41
Wait for Host Interface Response Time	1-43

Set Defaults

The following table lists the default settings for the standard and extended range scanners.

Description	Default Setting
Host Interface	None
Code Types	All Enabled
Code Lengths	
Code 39	1 to 55
Code 128	3 to 55
Codabar	2 to 55
I 2 of 5	14
D 2 of 5	14
MSI Plessey	1 to 55
Decode Options	
Transmit UPC-A Check Digit	Enabled
Transmit UPC-E Check Digit	Enabled
Convert UPC-E to UPC-A	Disabled
EAN Zero Extend	Disabled
Transmit No Decode Message	Disabled
Decode UPC/EAN Supplemental	Disabled
ITF-14/EAN-13 Conversion	Enabled
Transmit Code 39 Check Digit	Disabled
MSI Plessey Check Digit	1
Buffer Code 39	Disabled
Beeper Volume	High

Table continued on the next page.

AB PLCs

Description	Default Setting
Beep After Good Decode	Enabled
UPC/EAN Security Level	0
Decode Redundancy	0
UPC-A Preamble	System Character
UPC-E Preamble	System Character
Pause Duration	0
Prefix Value	None
Suffix Value	7013 (<Enter> for wedges, <CR/LF> for serial devices)
Scan Data Transmission Format	Data As Is
Laser Control	
Laser On Time-Out	3 Seconds
RS-232C Options	
Baud Rate	9600
Parity	Odd
Check Parity	Enabled
Hardware Handshaking	None
Software Handshaking	None
Serial Response Time-out	2 Seconds
Stop Bit Select	2
ASCII Data Format	7-bit
RTS Line State	Low
Intercharacter Delay	0
Transmit Code ID Character	Disabled
Transmit AIM Code ID	Disabled
Ignore Unknown Characters	Enabled
International Keypad Emulation	Disabled

Table continued on the next page.

Description	Default Setting
International Keypad Emulation Fast Xmit	Disabled
National Keyboard Type	U.S. English
Set Transmission Frequency (Channel)	50
Wait for Host Interface Response Time	00

Scan this bar code to set the default settings.

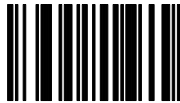

Set Defaults

AB PLCs

Host Interface Code

Scan the appropriate bar code below to select the host type you are using.



Single Port RS-232

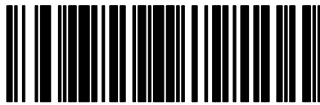

IBM PC/AT PS2-50, -55sx, -60, -70, -80 and Clones

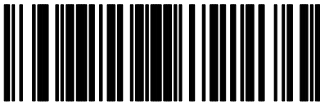

IBM PC/XT and Clones

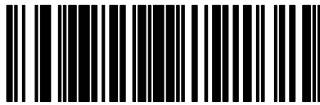

IBM PS2-30 and Clones

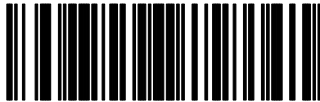

DEC VT 2xx/3xx/4xx

Code Types

Scan the appropriate bar code below to select the code type.



Enable All Code Types



Disable All Code Types

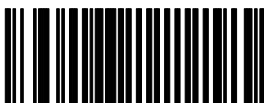

Add Code 39

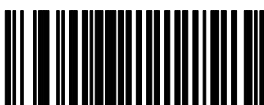

Delete Code 39

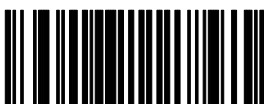

Add Code 39 Full ASCII

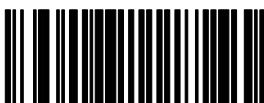

Delete Code 39 Full ASCII

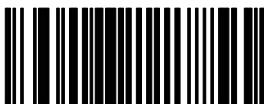

Add UPC/EAN

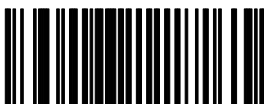

Delete UPC/EAN

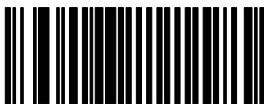

Add Code 128

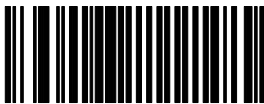

Delete Code 128

AB PLCs

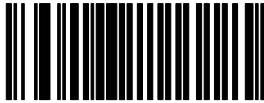

Add EAN 128

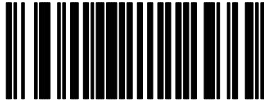

Delete EAN 128

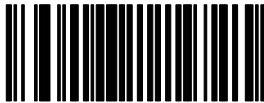

Add D 2 of 5

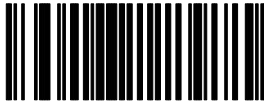

Delete D 2 of 5

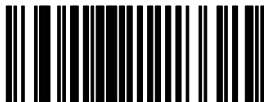

Add I 2 of 5

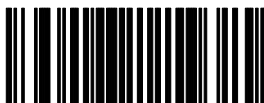

Delete I 2 of 5

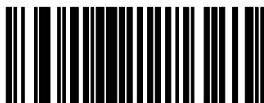

Add Codabar

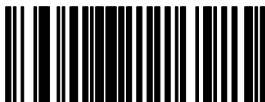

Delete Codabar

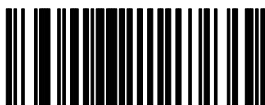

Add MSI Plessey

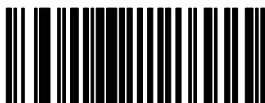

Delete MSI Plessey

Code Lengths

Scan the appropriate bar codes to select the length type and number. Each length must have two digits. For example, the number three is comprised of the zero and 3 bar codes. The number 12 is comprised of the 1 and 2 bar codes.



Code 39 – Any Length



Code 39 – Length Within Range



Code 39 – 1 Discrete Length



Code 39 – 2 Discrete Lengths



Code 128 – Any Length



Codabar – Any Length



Codabar – Length Within Range

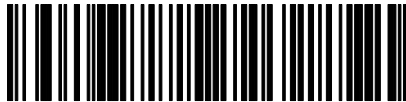

Codabar – 1 Discrete Length



Codabar – 2 Discrete Lengths



I 2 of 5 – Any Length



I 2 of 5 – Length Within Range

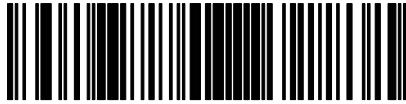

I 2 of 5 – 1 Discrete Length

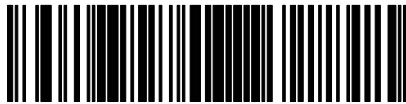

I 2 of 5 – 2 Discrete Lengths



D 2 of 5 – Any Length



D 2 of 5 – Length Within Range

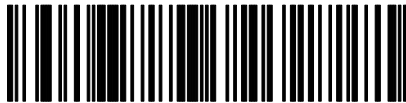

D 2 of 5 – 1 Discrete Length



D 2 of 5 – 2 Discrete Lengths

AB PLCs

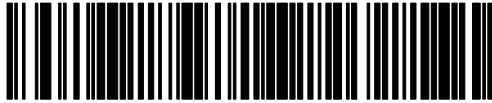

MSI Plessey – Any Length

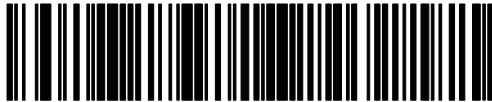

MSI Plessey – Length Within Range

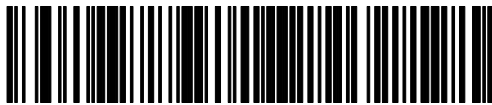

MSI Plessey – 1 Discrete Length

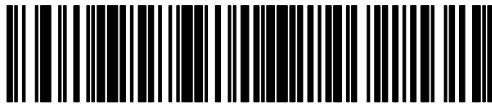

MSI Plessey – 2 Discrete Lengths



0



1



2

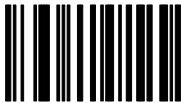

3



5

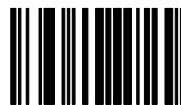

7



9

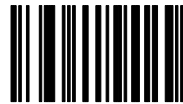

4



6



8



Cancel

AB PLCs

Decode Options

Scan the appropriate bar code to enable or disable the decode option.



Transmit UPC-A Check Digit*



Do Not Transmit UPC-A Check Digit

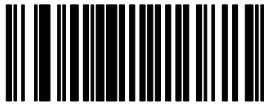

Transmit UPC-E Check Digit*

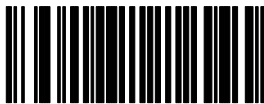

Do Not Transmit UPC-E Check Digit

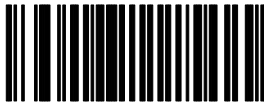

Enable 1 MSI Plessey Check Digit*

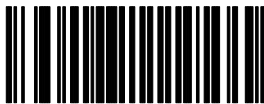

Enable 2 MSI Plessey Check Digits



Convert UPC-E to UPC-A

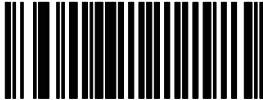

Do Not Convert UPC-E to UPC-A*

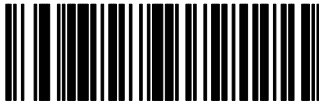

Decode UPC/EAN Supplementals



Ignore UPC/EAN Supplementals



Autodiscriminate UPC/EAN Supplementals

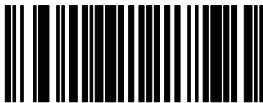

Enable EAN Zero Extend

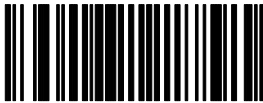

Disable EAN Zero Extend*

AB PLCs

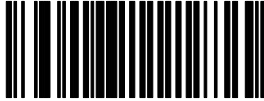

Transmit No Decode Message

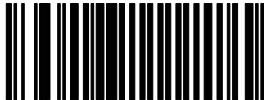

Do Not Transmit No Decode Message*

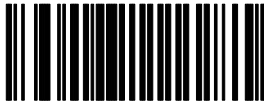

ITF14/EAN-13 Conversion Enabled*

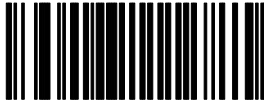

ITF14/EAN-13 Conversion Disabled

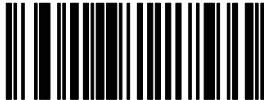

Buffer Code 39

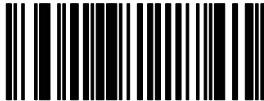

Do Not Buffer Code 39*

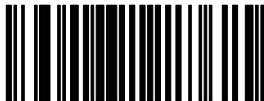

Verify Code 39 Check Digit

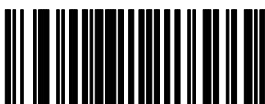

Do Not Verify Code 39 Check Digit*



Bi-directional Redundancy Enabled*



Bi-directional Redundancy Disabled



Beep After Good Decode*



Do Not Beep After Good Decode



Low Beeper Volume



High Beeper Volume*

AB PLCs

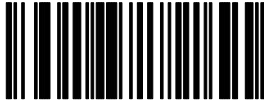

UPC/EAN Security Level 0*

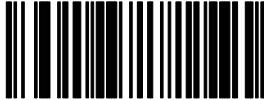

UPC/EAN Security Level 1

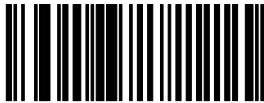

UPC/EAN Security Level 2

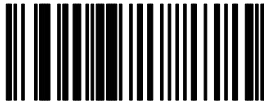

UPC/EAN Security Level 3



Decode Redundancy 1



Decode Redundancy 2



Decode Redundancy 3

UPC-A Preamble

Scan the appropriate bar code to select one preamble option.

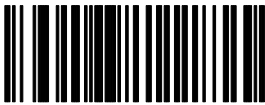

None

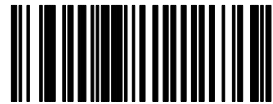

System Character*



System Character and Country Code

UPC-E Preamble

Scan the appropriate bar code to select one preamble option.



None

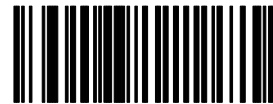

System Character*



System Character and Country Code

AB PLCs

Pause Duration

Scan the Pause Duration bar code and then scan two numbered bar codes which represent the desired pause. The pause is measured in 0.1 second increments. If you make an error, scan the Cancel bar code and start again.

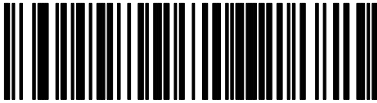

Pause Duration



1



3



5



0*



2



4

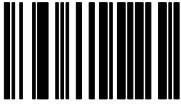

6

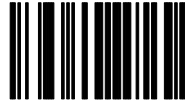

7



8



9

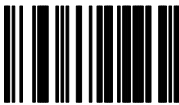

Cancel

AB PLCs

Prefix and Suffix

Scan the Prefix or Suffix bar code and then scan 4 numbered bar codes which represent the desired prefix or suffix. The Enter key (7013) is the default for all options. If you make an error, scan the Cancel bar code and start again.

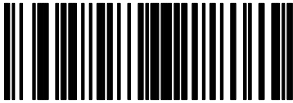

Scan Suffix (Value 1)

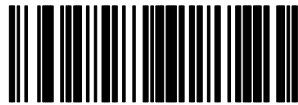

Scan Prefix (Value 2)



0



1

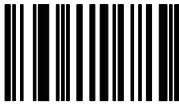

2

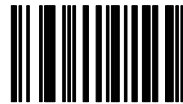

3

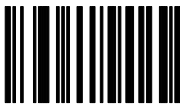

4



5



7



9



6



8



Cancel

AB PLCs

Data Transmission Formats

Scan the:

1. Scan Options bar code.
2. bar code corresponding to the desired converted data format.
3. Enter bar code.

If you make an error, scan the Cancel bar code and start again.

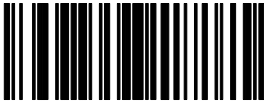

Scan Options



Data As Is*

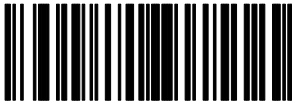

<Prefix><Data>

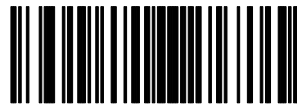

<Data><Suffix>

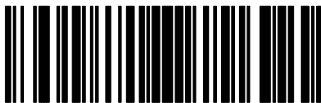

<Prefix><Data><Suffix>



Enter



Erase All Formats



Erase Last Entered Format



Cancel



Enter

AB PLCs

Laser Control

Scan the Laser On Time-Out bar code and then the two bar codes corresponding to the desired time. The pause is measured in 0.5 second increments from 0.5 seconds to 6.0 seconds. If you make an error, scan the Cancel bar code and start again.

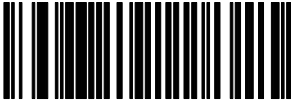

Laser On Time-Out



1

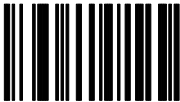

3



5



0

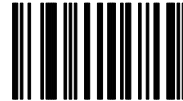

2



4

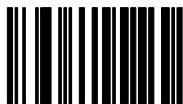

6



7



8



9

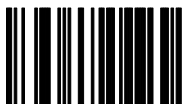

Cancel

AB PLCs

Baud Rate

Scan one of the following bar codes to select the appropriate baud rate for RS-232 transmission.

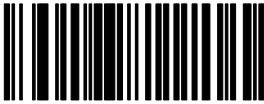

110



300

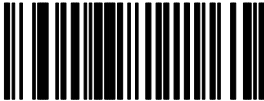

600

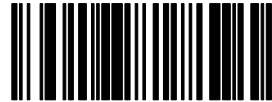

1200

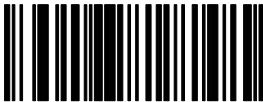

2400



4800

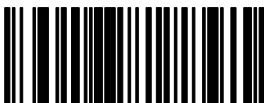

9600*



19200

Parity

Scan the appropriate bar code to set the parity of RS-232 transmissions.

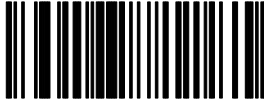

Odd*

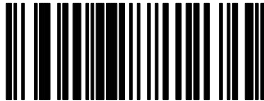

Even

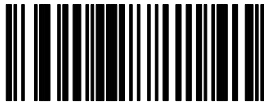

Mark

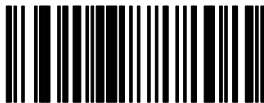

Space

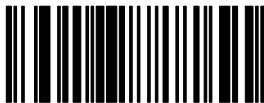

None

AB PLCs

Check Parity

Scan the appropriate bar code to check parity of RS-232 transmissions.

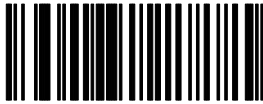

Check Parity*

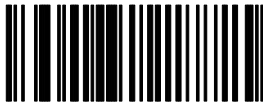

Do Not Check Parity

Hardware Handshaking

Scan the appropriate bar code to select an RS-232 hardware handshaking protocol.

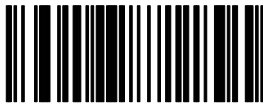

None*



RTS/CTS

Software Handshaking

Scan the appropriate bar code to select an RS-232 software handshaking protocol.



None*

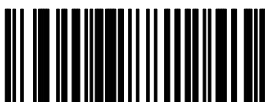

ACK/NAK



ACK/NAK with ENQ



ENQ Only

AB PLCs

Serial Response Time-Out

Scan the Serial Response Time-Out bar code and then the two bar codes corresponding to the desired time-out. The delay can range from zero seconds to 9.9 seconds. If you make an error, scan the Cancel bar code and start again.

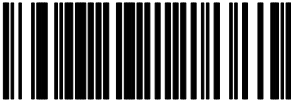

Serial Response Time-Out

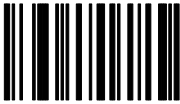

1

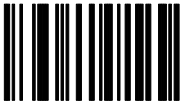

3



5



0



2



4

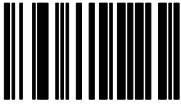

6



7



8

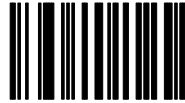

9

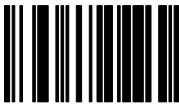

Cancel

Stop Bit Select

Scan the appropriate bar code to select the number of stop bits for RS-232 communication.



1 Stop Bit



2 Stop Bits*

AB PLCs

ASCII Format

Scan the appropriate bar code to select either a 7-bit or 8-bit ASCII format for RS-232 communication.



7-bit*



8-bit

RTS Line State

Scan the appropriate bar code to select the desired option.

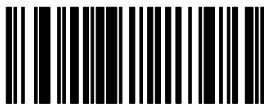

Line High



Line Low*

Intercharacter Delay

Scan the Intercharacter Delay bar code and then the two bar codes corresponding to the desired delay. The delay can range from zero seconds to 0.0099 seconds. If you make an error, scan the Cancel bar code and start again.



Intercharacter Delay



1



3



5



0



2



4

AB PLCs

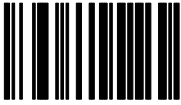

6



7

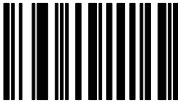

8

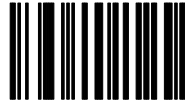

9



Cancel

Transmit Code ID Character

Scan the appropriate bar code to enable or disable this parameter.



Transmit Code ID Character

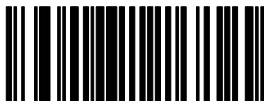

Do Not Transmit Code ID Character *

Transmit AIM Code ID

Scan the appropriate bar code to enable or disable this parameter.



Transmit AIM Code ID

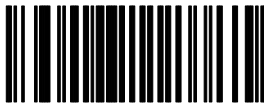

Do Not Transmit AIM Code ID*

Ignore Unknown Characters

Scan the appropriate bar code to enable or disable this parameter.



Enable*



Disable

AB PLCs

International Keyboard Emulation

Scan the appropriate bar code to enable or disable this parameter.

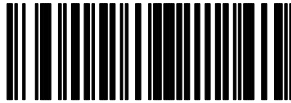

Enable

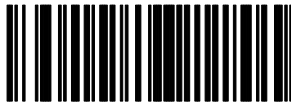

Disable*

International Keyboard Emulation Fast Transmit

Scan the appropriate bar code to enable or disable this parameter.



Enable

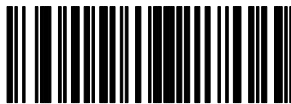

Disable*

National keyboard Types

Scan the appropriate bar code to select a keyboard type.

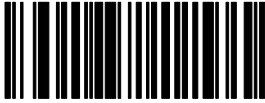

US English*

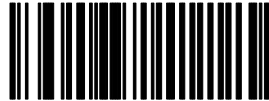

French

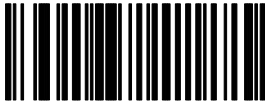

German

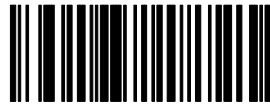

French International

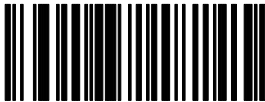

Spanish



Italian



Swedish



UK English

AB PLCs

Set Transmission Frequency

Scan the Set Transmission Frequency bar code and then the two bar codes to set the two digit channel number. If you make an error, scan the Cancel bar code and start again.

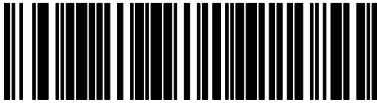

Select Channel Number

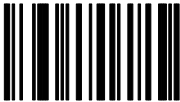

1



3



5



0



2



4

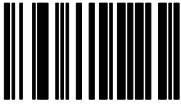

6

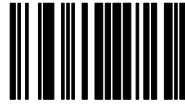

7

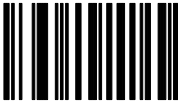

8

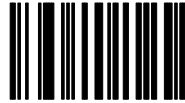

9

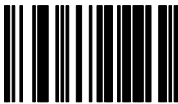

Cancel

AB PLCs

Wait for Host Interface Response Time

Scan the Wait for Host Interface Response Time bar code and then the two bar codes to set the two digit response time. The delay can range from zero seconds to 99 seconds. If you make an error, scan the Cancel bar code and start again. Programming a zero enables the automatic Wait for a Host Response Timeout calculation feature.

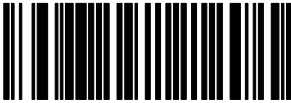

Wait for Host Interface Response Time

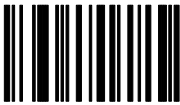

1



3



5

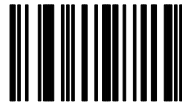

0



2



4

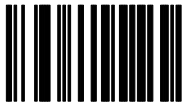

6



7



8

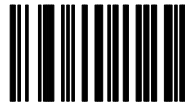

9

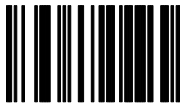

Cancel

AB PLCs

Advanced Data Format Bar Codes

This chapter explains what Advanced Data Format (ADF) is and lists the bar codes you can use with the standard range and long range scanners (Catalog Nos. 2755-HCG-4 and 2755-HCG-7). The following table lists the bar code categories within this chapter.

Parameter	Page Location
Criteria	2-4
Special Commands	2-10
Actions	2-11
Numeric Keypad	2-52
Alphanumeric Keypad	2-54

ADF Overview

ADF allows you to customize input before it is transmitted to your host device. For example, instead of having a direct read of a bar code, you can now attach a message to it. ADF is implemented with a series of bar codes that have selectable parameters. (You do not have to type in the individual characters for your message but rather scan in the appropriate bar code located in this chapter.) This series of bar codes is called a Rule and is used to evaluate input from the scanner. Rules are comprised of Criteria and Actions. Criteria are composed of an Input Source, Code Type, and Code Length. Actions are composed of Send Data, Send Keystroke, Setup Pause, and Send Preset Value. Criteria, Actions, and entire Rules may be erased by scanning the appropriate bar code.

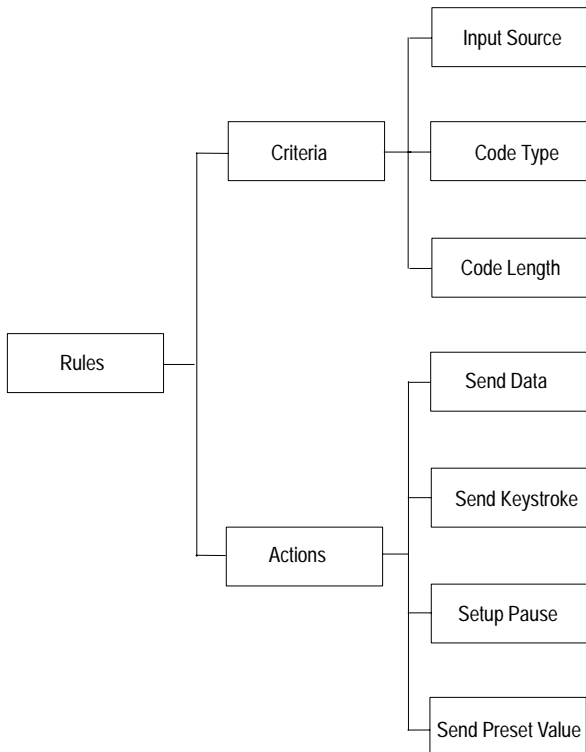

Criteria

Criteria are used to select the bar codes that the Actions act upon. Criteria are composed of an Input Source, Code Type, and Code Length. Input Source is the source affected by using using ADF and is selected prior to creating any ADF rules. Code Type is the symbology selected. All code types must be scanned in succession prior to selecting other criteria. If you don't select a code type, all code types are affected. Code Length allows you to define the number of characters the selected code type must contain. You can select multiple lengths for each rule. If you do not select a code length, selected code types of any length are affected.

Actions

Actions allow you to select how to format data for transmission. Actions are composed of Send Data, Send Keystroke, Setup Pause, and Send Preset Value. Send Data allows you to send all the data that follows, send all the data up to a specific character selected from the alphanumeric keyboard bar code, or send the next number of characters (1 to 254) selected from the alphanumeric keyboard. Send Keystroke allows you to scan the bar code for the keystroke you wish to send. Setup Pause allows you to set the pause duration parameter prior to entering ADF. Send Preset Value allows you to send values 1 or 2 by scanning the appropriate bar code.

- value 1 = scan suffix
- value 2 = scan prefix

Rules Hierarchy

The last rule entered is the first rule read by the scanner. The scanner reads the information and determines what needs to be accomplished. If the last rule read is valid, the scanner may not go on to the other rules so positioning of the rules is very important.

Criteria

Scan:

1. the code types together before selecting other Criteria.
2. the input source.
3. one length per Rule.

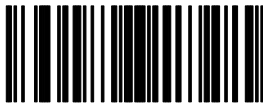

Code 39

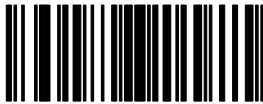

Code 128

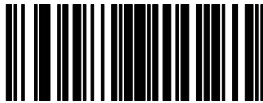

I 2 of 5

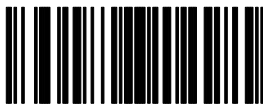

Codabar



D 2 of 5

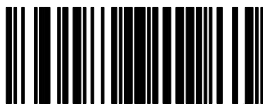

UPC-A

AB PLCs

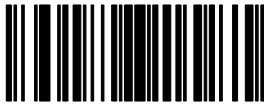

UPC-E



EAN-8



EAN-13



UPC/EAN

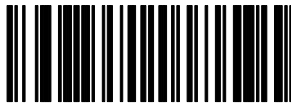

Any Source

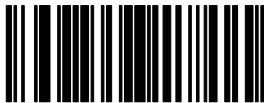

Scanner Port

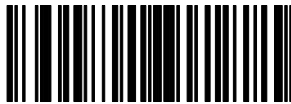

1

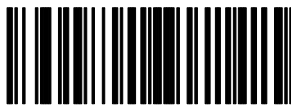

2

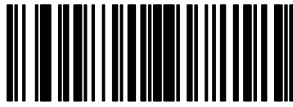

3

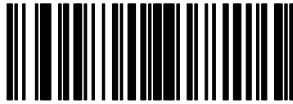

4

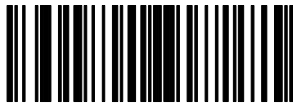

5

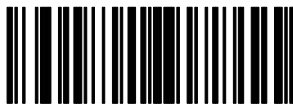

6

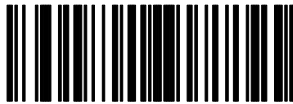

7

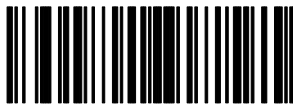

8

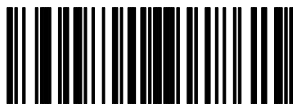

9



10

AB PLCs



11

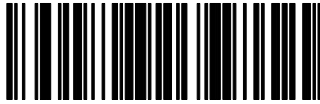

12

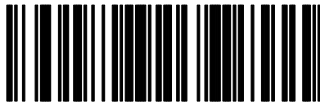

13



14

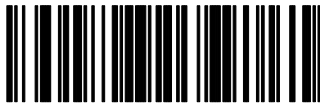

15



16

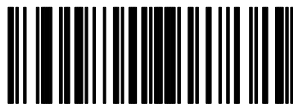

17

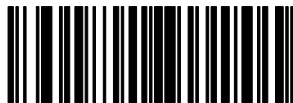

18



19

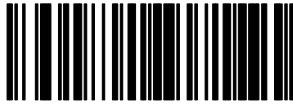

20



21

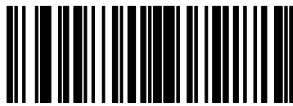

22

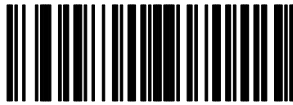

23

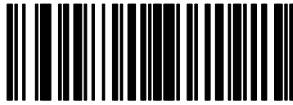

24



25



26

AB PLCs

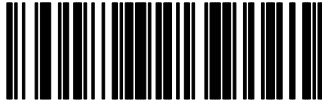

27

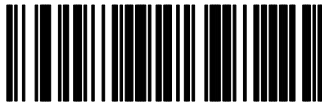

28



29

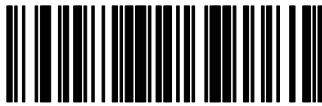

30

Special Commands

Scan the appropriate bar code below after scanning a criteria.



Erase Criteria and Start Again

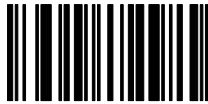

Erase Actions and Start Again



Quit Entering Rules



Save Rule



Erase Previously Saved Rule

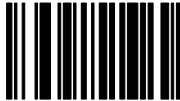

Erase All Rules

AB PLCs

Actions

Scan the appropriate bar code to enable the desired action.



Send Pause



Send Value 1



Send Value 2



Send Value 3



Send Value 4

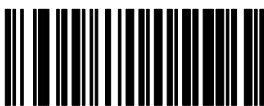

Send All Data That Remains



Send Next Character



Send Next 2 Characters



Send Next 3 Characters



Send Next 4 Characters



Send Next 5 Characters



Send Next 6 Characters



Send Next 7 Characters



Send Next 8 Characters



Send Next 9 Characters

AB PLCs



Send Next 10 Characters



Send Next 11 Characters



Send Next 12 Characters



Send Next 13 Characters

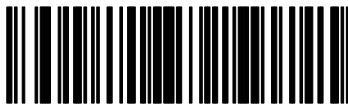

Send Next 14 Characters

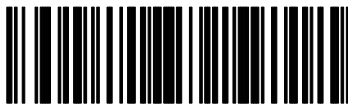

Send Next 15 Characters



Send Next 16 Characters



Send Next 17 Characters



Send Next 18 Characters



Send Next 19 Characters



Send Next 20 Characters

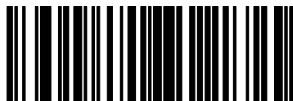

Send Account Number

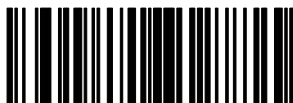

Send Exp Date (MMYY)



Send Exp date (YYMM)



Send Customer Name



Select Track 1 Data

AB PLCs

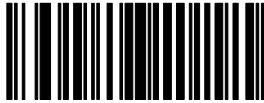

Select Track 2 Data

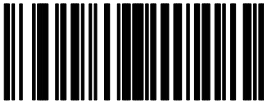

Select Track 3 Data

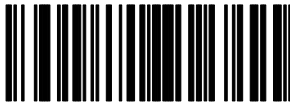

Send Discretionary Data



Skip Ahead 1 Character



Skip Ahead 2 Characters



Skip Ahead 3 Characters

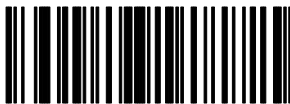

Skip Ahead 4 Characters



Skip Ahead 5 Characters

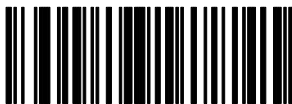

Skip Ahead 6 Characters

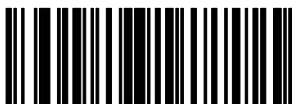

Skip Ahead 7 Characters



Skip Ahead 8 Characters

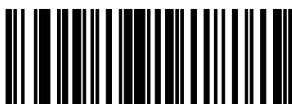

Skip Ahead 9 Characters



Skip Ahead 10 Characters



Send Control 2



Send Control A



Send Control B

AB PLCs



Send Control C

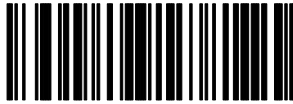

Send Control D



Send Control E



Send Control F



Send Control G

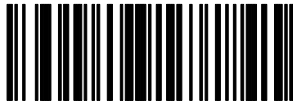

Send Control H



Send Control I

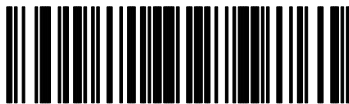

Send Control J



Send Control K

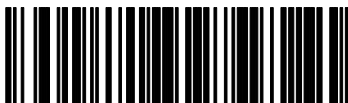

Send Control L

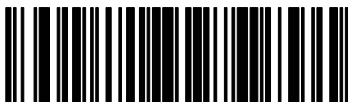

Send Control M

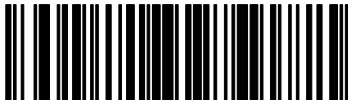

Send Control N

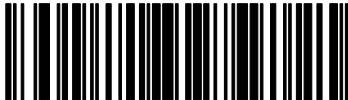

Send Control O

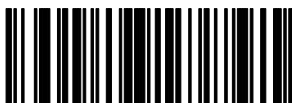

Send Control P

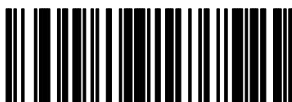

Send Control Q

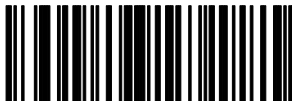

Send Control R

AB PLCs



Send Control S



Send Control T



Send Control U



Send Control V



Send Control W



Send Control X



Send Control Y



Send Control Z

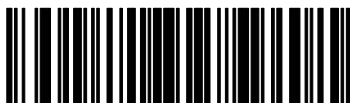

Send Control [

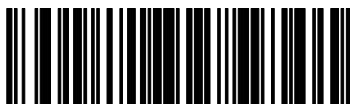

Send Control \

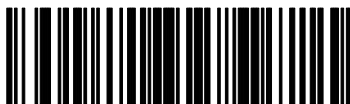

Send Control]

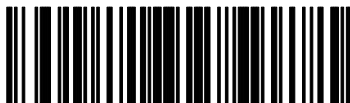

Send Control 6

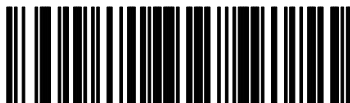

Send Control -



Send Space



Send !



Send "

AB PLCs



Send #



Send \$



Send %



Send &



Send '



Send (/



Send)

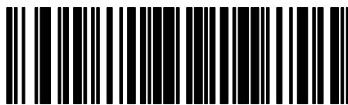

Send *

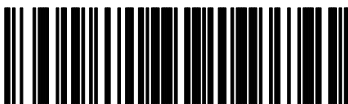

Send +

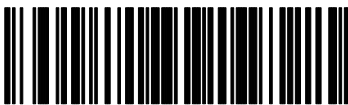

Send ,

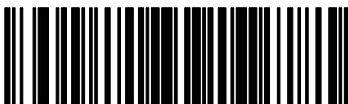

Send -

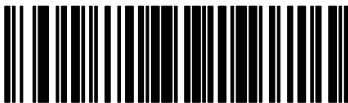

Send .

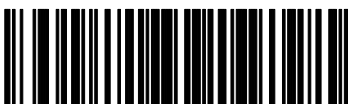

Send /



Send 0



Send 1



Send 2

AB PLCs



Send 3

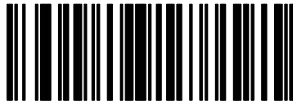

Send 4



Send 5



Send 6



Send 7



Send 8



Send 9



Send :



Send ;

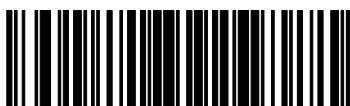

Send <

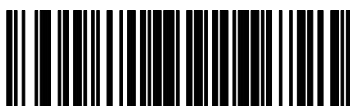

Send =

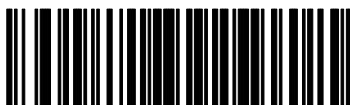

Send >

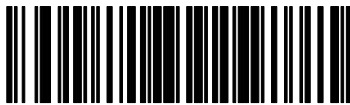

Send ?



Send @



Send A



Send B

AB PLCs



Send C

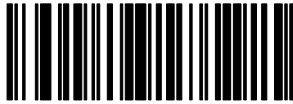

Send D



Send E



Send F



Send G



Send H



Send I

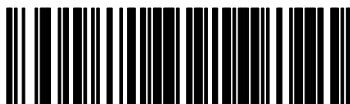

Send J



Send K

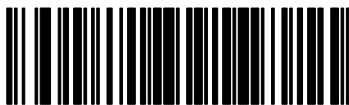

Send L

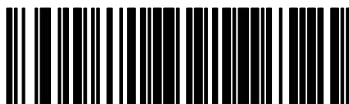

Send M

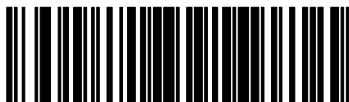

Send N

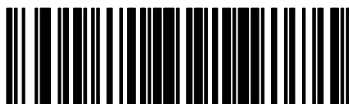

Send O

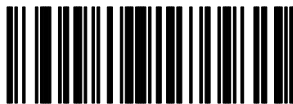

Send P



Send Q

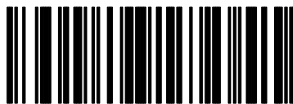

Send R

AB PLCs



Send S

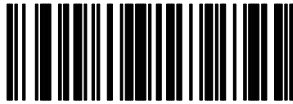

Send T



Send U



Send V



Send W



Send X



Send Y



Send Z

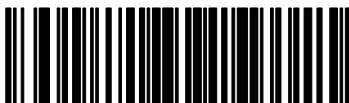

Send [

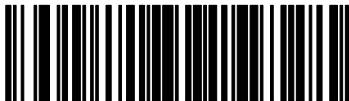

Send \

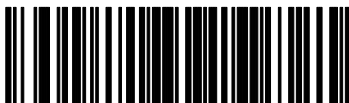

Send]

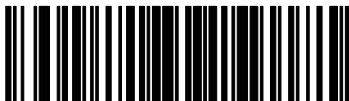

Send ^

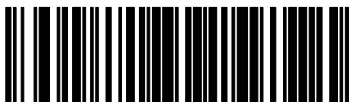

Send _

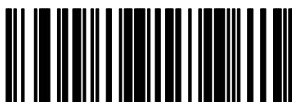

Send '



Send a

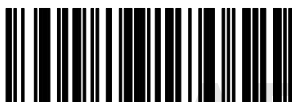

Send b

AB PLCs



Send c

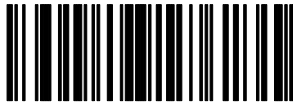

Send d



Send e

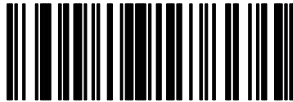

Send f

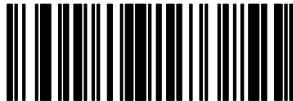

Send g



Send h



Send i

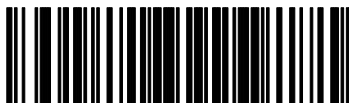

Send j

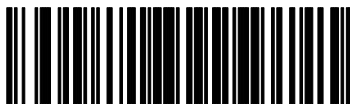

Send k

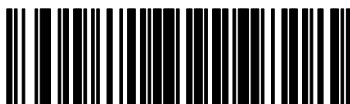

Send l

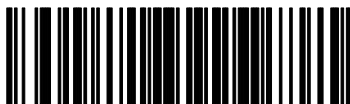

Send m

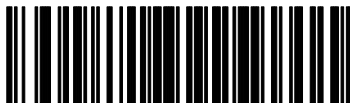

Send n

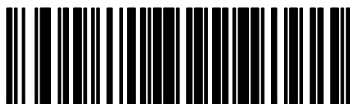

Send o



Send p



Send q



Send r

AB PLCs



Send s



Send t



Send u



Send v



Send w



Send x



Send y

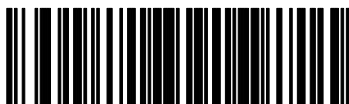

Send z

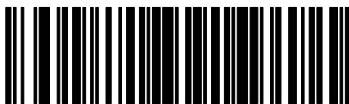

Send {

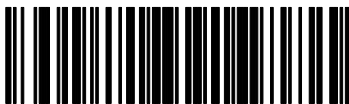

Send |

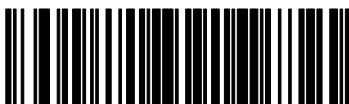

Send }

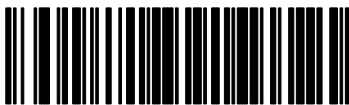

Send ~

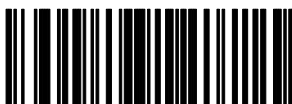

Send Alt 2



Send Alt A

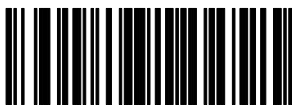

Send Alt B



Send Alt C

AB PLCs

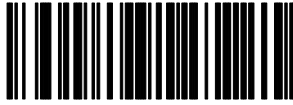

Send Alt D

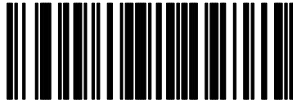

Send Alt E

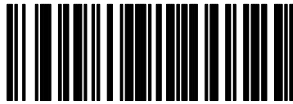

Send Alt F

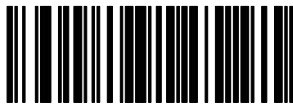

Send Alt G

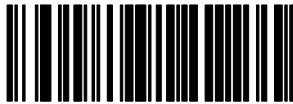

Send Alt H

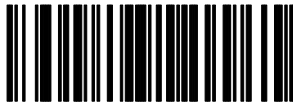

Send Alt I

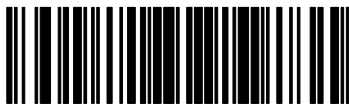

Send Alt J

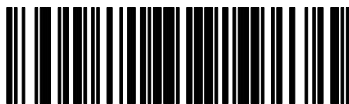

Send Alt K

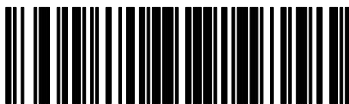

Send Alt L

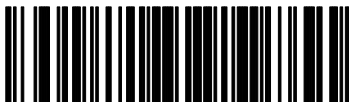

Send Alt M

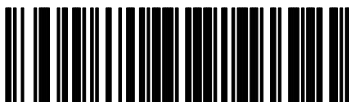

Send Alt N

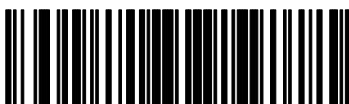

Send Alt O

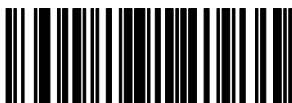

Send Alt P



Send Alt Q

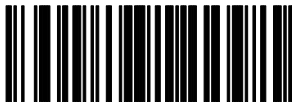

Send Alt R

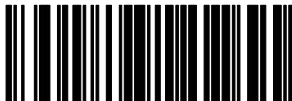

Send Alt S

AB PLCs

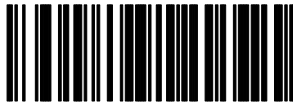

Send Alt T

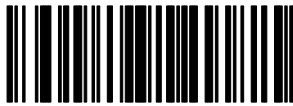

Send Alt U

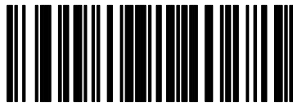

Send Alt V

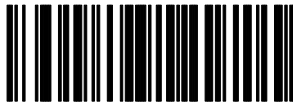

Send Alt W

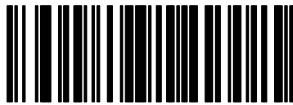

Send Alt X

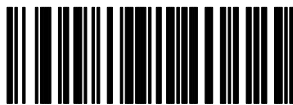

Send Alt Y

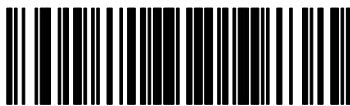

Send Alt Z

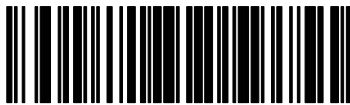

Send Alt [

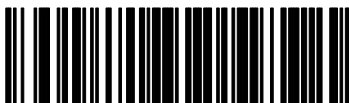

Send Alt \

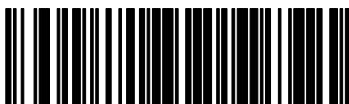

Send Alt]

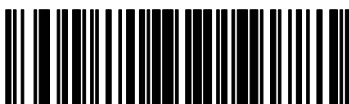

Send Alt 6

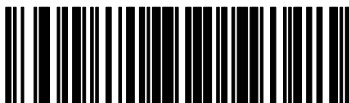

Send Alt -



Send PA 1



Send PA 2



Send CMD 1



Send CMD 2

AB PLCs



Send CMD 3



Send CMD 4



Send CMD 5



Send CMD 6



Send CMD 7

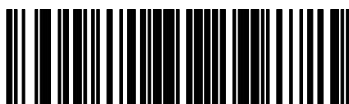

Send CMD 8

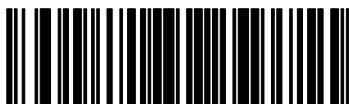

Send CMD 9



Send CMD 10

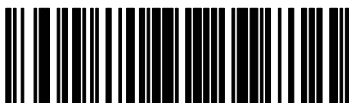

Send Yen Character

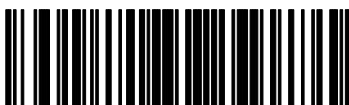

Send Pound Sterling Character

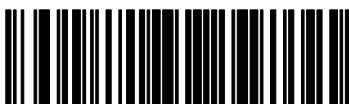

Send Bomb Character



Send Hook Character



Send Bullet Character



Send 1/2 Character



Send Paragraph Character



Send Section Character

AB PLCs



Send Vertical Character

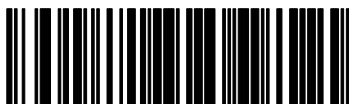

Send Keypad *

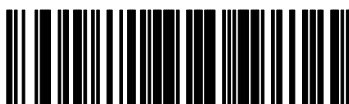

Send Keypad +

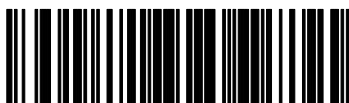

Send Keypad -

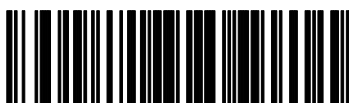

Send Keypad .

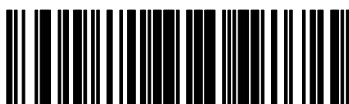

Send Keypad /



Send Keypad 0



Send Keypad 1



Send Keypad 2



Send Keypad 3



Send Keypad 4



Send Keypad 5



Send Keypad 6

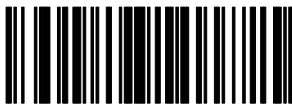

Send Keypad 7

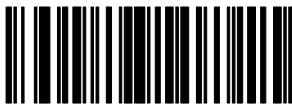

Send Keypad 8



Send Keypad 9

AB PLCs

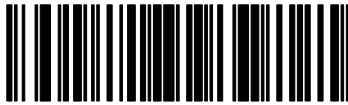

Send Keypad Enter



Send Keypad Num Lock



Send Break Key

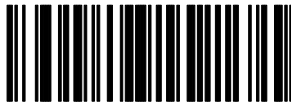

Send Delete Key



Send Page Up Key



Send End Key



Send Page Down Key



Send Pause Key

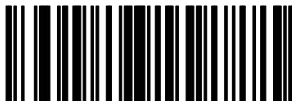

Send Scroll Lock Key



Send Backspace Key



Send Tab Key

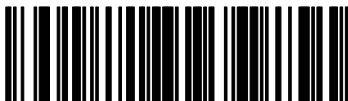

Send Print Screen Key

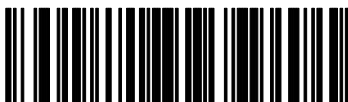

Send Insert Key

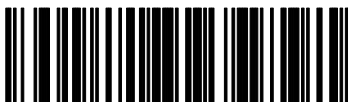

Send Home Key

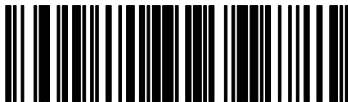

Send Enter Key

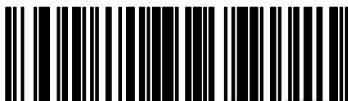

Send Escape Key

AB PLCs

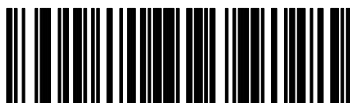

Send Up Arrow Key



Send Down Arrow Key



Send Left Arrow Key



Send Right Arrow Key



Send Back Tab Character

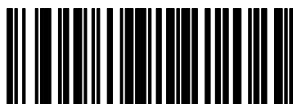

Send F1 Key

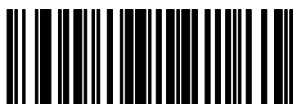

Send F2 Key

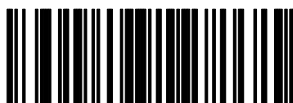

Send F3 Key



Send F4 Key

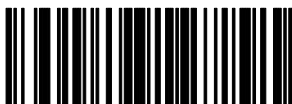

Send F5 Key



Send F6 Key



Send F7 Key

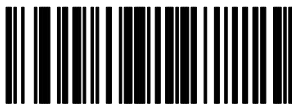

Send F8 Key



Send F9 Key

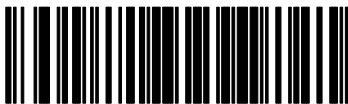

Send F10 Key

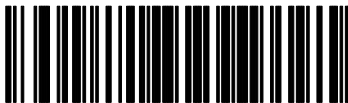

Send F11 Key

AB PLCs

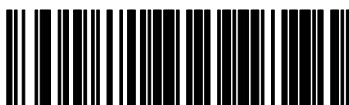

Send F12 Key

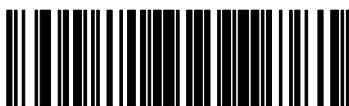

Send F13 Key



Send F14 Key



Send F15 Key



Send F16 Key



Send F17 Key

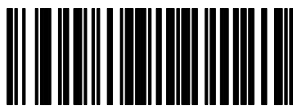

Send F18 Key



Send F19 Key

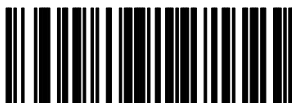

Send F20 Key

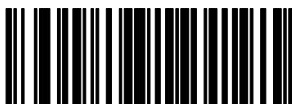

Send F21 Key



Send F22 Key



Send F23 Key



Send F24 Key



Send F25 Key

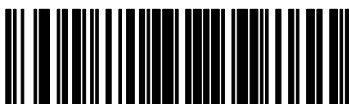

Send F26 Key

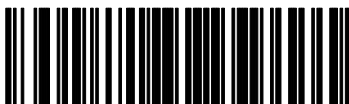

Send F27 Key

AB PLCs

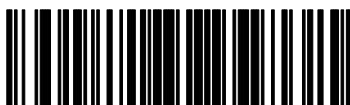

Send F28 Key

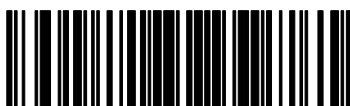

Send F29 Key

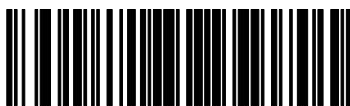

Send F30 Key



Send PF1 Key



Send PF2 Key



Send PF3 Key



Send PF4 Key



Send PF5 Key

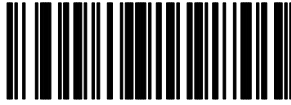

Send PF6 Key



Send PF7 Key

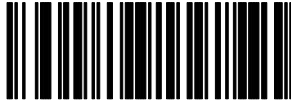

Send PF8 Key

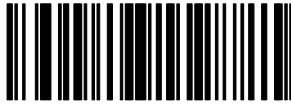

Send PF9 Key

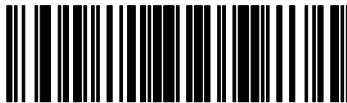

Send PF10 Key

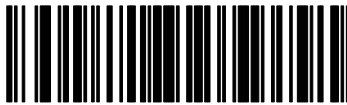

Send PF11 Key

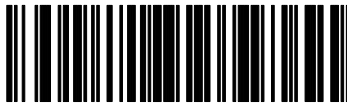

Send PF12 Key

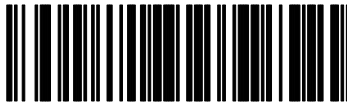

Send PF13 Key

AB PLCs



Send PF14 Key

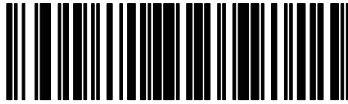

Send PF15 Key

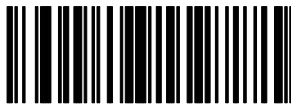

Send PF16 Key



Send PF17 Key



Send PF18 Key



Send PF19 Key



Send PF20 Key



Send PF21 Key

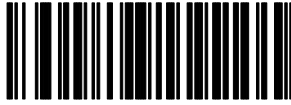

Send PF22 Key



Send PF23 Key

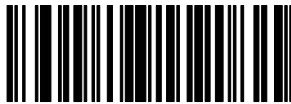

Send PF24 Key



Send PF25 Key



Send PF26 Key

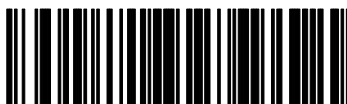

Send PF27 Key

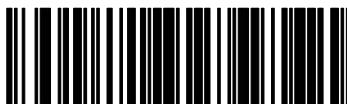

Send PF28 Key

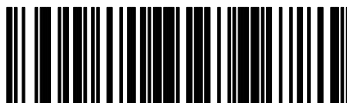

Send PF29 Key

AB PLCs



Send PF30 Key

Numeric Keypad

These keys are not the same as those on an alphanumeric keypad.



0



1



2



3



4



5

AB PLCs

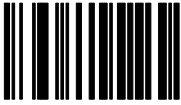

6

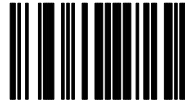

7



8

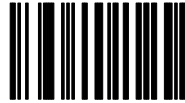

9

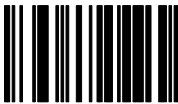

Cancel

Alphanumeric Keypad

These keys are the not the same as those on a numeric keypad.



Space



#

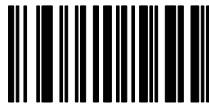

\$



%

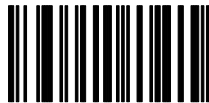

*



+



-

AB PLCs

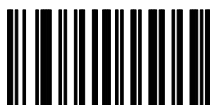

.



/



!



"

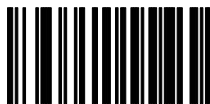

&

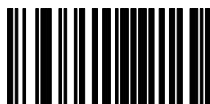

,



(

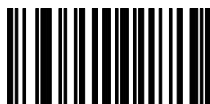

)



;



<



=



>

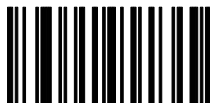

?



@



[

AB PLCs



\



A standard 1D barcode representing the caret character.

^

A standard 1D barcode representing the hyphen character.

-

A standard 1D barcode representing the slash character.

/

A standard 1D barcode representing the digit 0.

0

A standard 1D barcode representing the digit 1.

1

A standard 1D barcode representing the digit 2.

2

Publication 2755-6.6



3



4

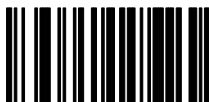

5

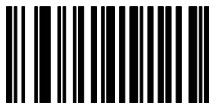

6

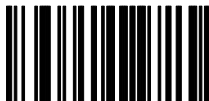

7



8



9



A

AB PLCs



B



C

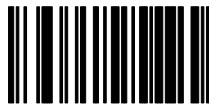

D



E



F



G



H

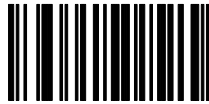

I

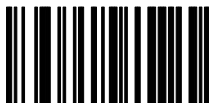

J

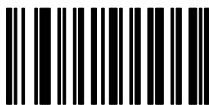

K



L



M

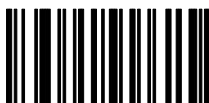

N

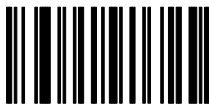

O

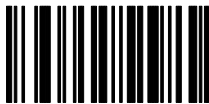

P



Q

AB PLCs

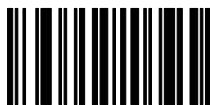

R



S



T



U

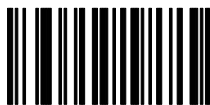

V

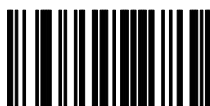

W

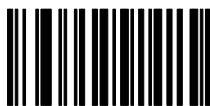

X



Y



Z



Cancel

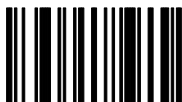

End of Message



a



b



c



d

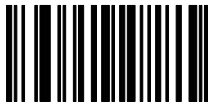

e

AB PLCs

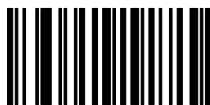

f



g



h

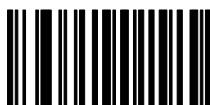

i

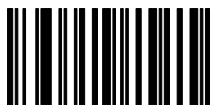

j



k



l



m

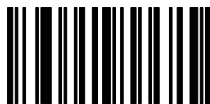

n

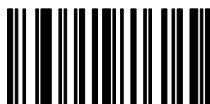

o

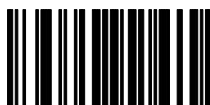

p

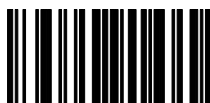

q

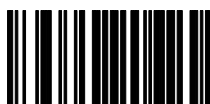

r

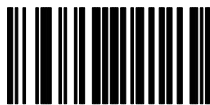

s



t



u

AB PLCs



v

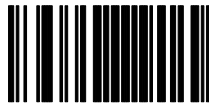

w

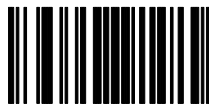

x

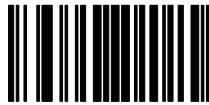

y

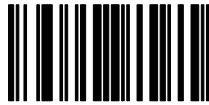

z

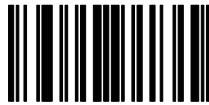

(



|

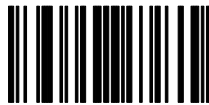

)



~

AB PLCs

Application Examples

This appendix is designed to illustrate various applications for the standard and long range cordless scanners (Catalog Nos. 2755-HCG-4 and 2755-HCG-7). Application examples include:

- enhanced decoder
- flexible interface module
- SLC 5/03™ and SLC 5/04™ controllers
- PLC-5® controller
- AdaptaScan™ pass-through
- DTAM™ Plus DeviceNet™

Because of the variety of uses for this information, the user of and those responsible for applying this information must satisfy themselves as to the acceptability of each application. In no event will Allen–Bradley Company be responsible or liable for indirect or consequential damages resulting from the use of application of this information.

The examples shown in this appendix are intended solely to illustrate the principles of the scanners and some of the methods used to apply them. Particularly because of the many requirements associated with any particular installation, Allen–Bradley Company cannot assume responsibility or liability for actual use based upon the illustrative uses and applications.

Enhanced Decoder

This application example describes how to configure and operate the scanners when using an RS-232 cable connected to the AUX port of an Allen-Bradley Enhanced Decoder (Catalog No. 2755-DD/DS). This application example also provides configuration information for an Auxiliary Port Pass-Through application for the enhanced decoder.



ATTENTION: Do not install the RS-232 cable with power applied to either the base/charger unit or enhanced decoder. Failure to follow this caution may result in damage to the scanner, base/charger unit, or enhanced decoder.

Refer to the *Enhanced Decoder User Manual* (Publication No. 2755-833) for additional information on the enhanced decoder.

AB PLCs

Hardware Connections for AUX Port Pass-Through

The base/charger unit connects to an input port on the enhanced decoder with an RS-232C cable (Catalog No. 2755-HCC-BR1-06).

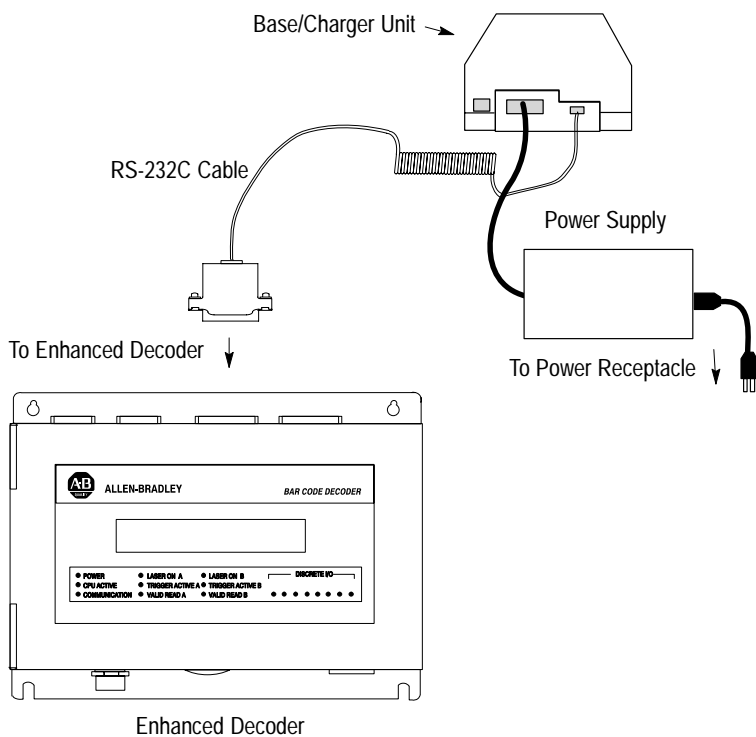

Configuration Codes for the AUX Port Pass-Through

After making the necessary connections, scan the bar codes starting below to set up the scanner for use with the enhanced decoder.

1. Scan the Set Defaults bar code.

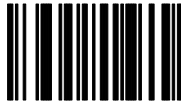

Set Defaults

2. Scan the Single Port RS-232 bar code.

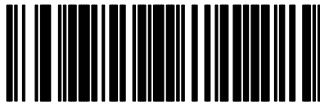

Single Port RS-232

3. Scan the Parity bar code.

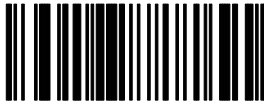

None

AB PLCs

4. Scan the Stop Bit Select bar code.



1 Stop Bit

5. Scan the ASCII Format bar code.



8-bit

Enhanced Decoder Setup for the AUX Port Pass-Through

You need to configure the enhanced decoder. Follow the steps below or refer to the *Enhanced Decoder User Manual* (Publication No. 2755-833).

1. Select Aux Terminal Data Entry (Screen 8) from the Main Menu.
2. Set Enable Keyboard Entry = **Yes**
3. Save and Exit the configuration.
4. Move internal selector (jumper) to the data entry position on the system board (B-5, B-6).
5. Make sure the hand-held scanner baud rate = **9600**, parity = **None**, data bits = **8**, and stop bits = **1**.
6. See Chapter 13 of *Enhanced Decoder User Manual* (Publication No. 2755-833) for additional information.

Flexible Interface Module

This application example describes how to configure and operate the scanners when using an RS-232 cable connected to the flexible interface module (Catalog No. 2760-RB).



ATTENTION: Do not install the RS-232 cable with power applied to either the base/charger unit or flexible interface module. Failure to follow this caution may result in damage to the scanner, base/charger unit, or flexible interface module.

Refer to the following publications for additional information.

- *Flexible Interface Module User Manual*
(Publication No. 2760-ND001)
- *SFC1 or SFC2 Protocol Cartridge User Manuals*
(Publication Nos. 2760-ND002 or 2760-822)

AB PLCs

Hardware Connections for the Flexible Interface Module

The base/charger unit connects to one of the three communication ports on the flexible interface module with an RS-232C cable (Catalog No. 2755-HCC-BR2-06). The interface module requires an SFC2 Protocol Cartridge.

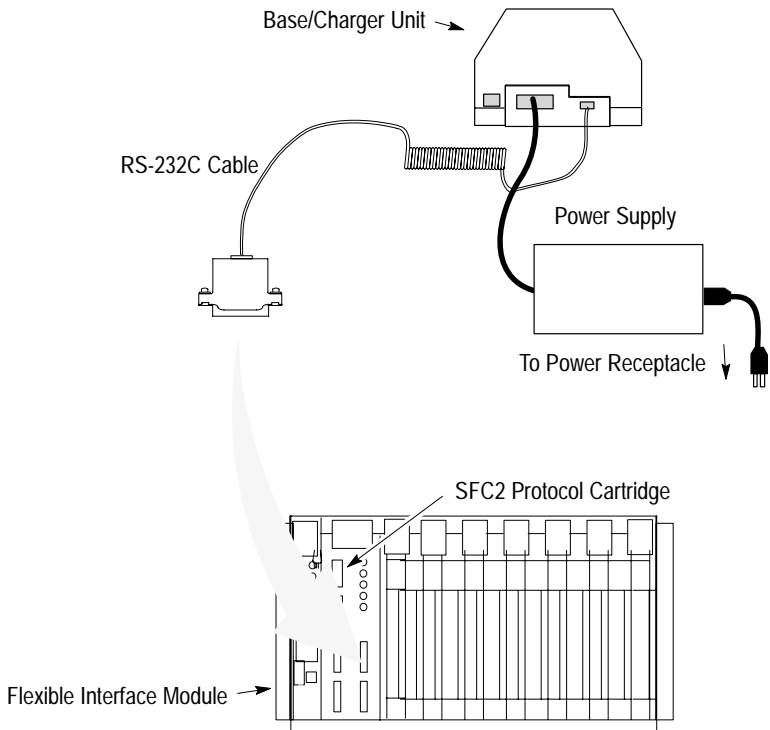

Configuration Codes for the Flexible Interface Module

After making the necessary connections, scan the bar codes starting below to set up the scanner for use with the flexible interface module.

1. Scan the Set Defaults bar code.

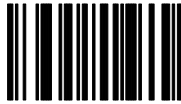

Set Defaults

2. Scan the Single Port RS-232 bar code.

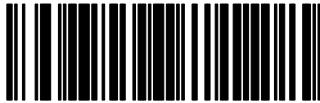

Single Port RS-232

3. Scan the Parity bar code.

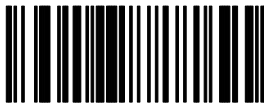

None

AB PLCs

4. Scan the ASCII Format bar code.



8-bit

The cable defaults work with the flexible interface module. Your application may have specific requirements. If you change a communication setting, make sure the flexible interface module is configured to accept the change.

Flexible Interface Module Setup

You need to configure the flexible interface module. Follow the steps below or refer to the *Flexible Interface Module User Manual* (Publication No. 2760-ND001) or the *SFC1 or SFC2 Protocol Cartridge User Manuals* (Publication Nos. 2760-ND002 or 2760-822).

1. Select 90B to reset the configuration to factory defaults.
2. Configure screens 3, 21, and 11 (in this order) as shown on the following pages.

2760-RB SERIES A REVISION J
COPYRIGHT 1989 ALLEN-BRADLEY COMPANY, INC.

1X - CONFIGURATION PARAMETERS	2X - IDENTIFICATION NUMBERS
3 - DEVICE PORT PROTOCOL NAMES	4DM - MATCH CODE ENTRIES
5I - DISCRETE BYTE INPUT ENTRIES	6 - THE DATA MATRIX ENTRIES
7 - THE PASS THROUGH ENTRIES	8 - NON-VOLATILE SCRATCH PAD AREA
9XF - RB MODULE FUNCTIONS	AX - HARDWARE DIAGNOSTICS
BX - SOFTWARE DIAGNOSTICS	C - EXIT CONFIGURATION MODE

WHERE X (0 TO 7) AND D (1 TO 3) ARE PORT NUMBERS WHICH ARE DEFINED BELOW :

0 - RB CMMND PRCSS 2 - SERIAL PORT 2 4 - CONFIG PORT 6 - I/O RACK SLT 1
1 - SERIAL PORT 1 3 - SERIAL PORT 3 5 - I/O RACK SLT 0 7 - RESERVED

WHERE F (A TO E) ARE FUNCTIONS THAT RB CAN PERFORM WHICH ARE DEFINED BELOW :

A - RESET B - SET DEFAULTS C - FLUSH D - INITIALIZE E - CLEAR DIAGS

WHERE M (A TO T) AND I (A TO H) ARE ENTRY NUMBERS FOR THE SELECTION MADE ABOVE.

ENTER A MAIN MENU SELECTION:

ENTER A MAIN MENU SELECTION: 3

PORT 1 = COPYRIGHT 1989 ALLEN-BRADLEY COMPANY, INC.
2760-SFC1 DT , SERIES A , REVISION B (YES/NO) = YES.

PORT 2 = COPYRIGHT 1989 ALLEN-BRADLEY COMPANY, INC.
2760-SFC1 DT , SERIES A , REVISION B (YES/NO) = YES.

PORT 3 = COPYRIGHT 1989 ALLEN-BRADLEY COMPANY, INC.
2760-SFC1 DT , SERIES A , REVISION B (YES/NO) = YES.

EDIT THIS SELECTION (YES/NO) ?

AB PLCs

ENTER A MAIN MENU SELECTION: 21

DUMB TERM. UNSPECIFIED PROTOCOL, 13fh (YES/NO) = YES.

EDIT THIS SELECTION (YES/NO) ?

ENTER A MAIN MENU SELECTION: 11

MODEM CONTROL (ENABLE/DISABLE) = DISABLE.

9600 BITS PER SECOND (YES/NO) = YES.

8 BITS NO PARITY (YES/NO) = YES.

XON/XOFF (ENABLE/DISABLE) = DISABLE.

RS232 (YES/NO) = YES.

RECEIVE MATRIXING (ENABLE/DISABLE) = DISABLE.

BYTE SWAPPING (ENABLE/DISABLE) = ENABLE.

BINARY DATA NO CONVERSIONS (YES/NO) = YES.

HDR/TLR ON OUTPUT (ENABLE/DISABLE) = ENABLE.

HEADER BYTE LENGTH (DEC 0..4) = 0.

HEADER DATA[0] (HEX 0...ff) = 0.

HEADER DATA[1] (HEX 0...ff) = 0.

HEADER DATA[2] (HEX 0...ff) = 0.

HEADER DATA[3] (HEX 0...ff) = 0.

TRAILER BYTE LENGTH (DEC 0..4) = 2.

TRAILER DATA[0] (HEX 0...ff) = a.

TRAILER DATA[1] (HEX 0...ff) = d.

TRAILER DATA[2] (HEX 0...ff) = 0.

TRAILER DATA[3] (HEX 0...ff) = 0.

MAX DATA BYTE LENGTH (DEC 0...124) = 0.

MIN DATA BYTE LENGTH (DEC 0...124) = 0.

CONTINUE THIS SELECTION (YES/NO) ?

3. Make sure PLC program is written to access Flexible Interface Module data.

SLC 5/03 and SLC 5/04 Controllers

This application example describes how to configure and operate the scanners when using an RS-232 cable connected to the SLC 5/03 (Catalog No. 1747-L532) and SLC 5/04 controllers (Catalog Nos. 1747-L541, 1747-L542, and 1747-L543).



ATTENTION: Do not install the RS-232 cable with power applied to either the base/charger unit or SLC 5/03 or SLC 5/04 controllers. Failure to follow this caution may result in damage to the scanner, base/charger unit, or SLC 5/03 or SLC 5/04 controllers.

Refer to the following publications for additional information.

- *SLC 500 Modular Hardware Style Installation and Operation Manual* (Publication No. 1747-6.2)
- *SLC 500 and MicroLogix™ 1000 Instruction Set Reference Manual* (Publication No. 1747-6.15)
- *Advanced Programming Software User Manual* (Publication No. 9399-APSUM-11.15.95)

AB PLCs

Hardware Connections for the SLC 5/03 and SLC 5/04 Controllers

The base/charger unit connects to one of the communication ports on the SLC 5/03 or SLC 5/04 controllers with an RS-232C cable (Catalog No. 2755-HCC-BR1-06). You need to use a 25–9 pin connector as shown below.

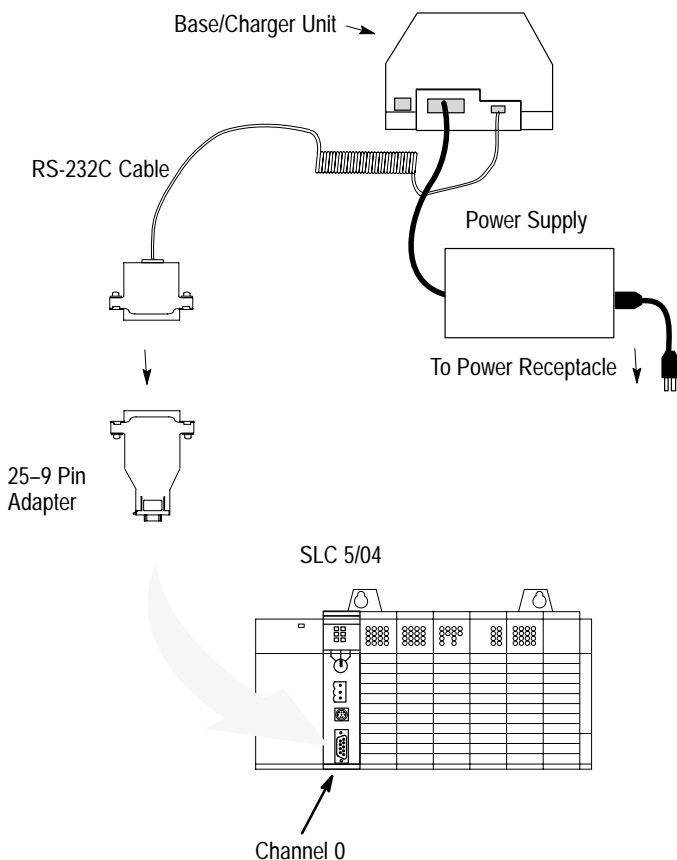

Configuration Codes for the SLC 5/03 and SLC 5/04 Controllers

After making the necessary connections, scan the bar codes starting below to set up the scanner for use with the SLC 5/03 and SLC 5/04 controllers.

1. Scan the Set Defaults bar code.

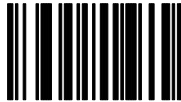

Set Defaults

2. Scan the Single Port RS-232 bar code.

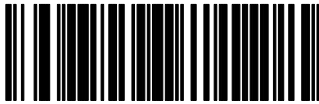

Single Port RS-232

AB PLCs

3. Scan the following bar codes.

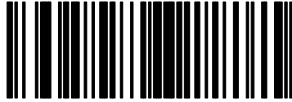

Scan Suffix (Value 1)

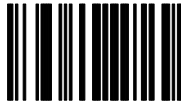

7



0



1



3

4. Scan the Data Transmission Format bar code.

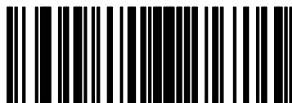

<Data><Suffix>

5. Scan the Parity bar code.



Even

The cable defaults work with the SLC 5/03 and SLC 5/04 controllers. Your application may have specific requirements. If you change a communication setting, make sure the SLC 5/03 and SLC 5/04 controllers are configured to accept the change.

AB PLCs

SLC 5/03 and SLC 5/04 Controllers Setup

You need to configure the SLC 5/03 and SLC 5/04 controllers. Follow the steps starting below or refer to the following publications:

- *SLC 500 Modular Hardware Style Installation and Operation Manual* (Publication No. 1747-6.2)
- *SLC 500 and MicroLogix™ 1000 Instruction Set Reference Manual* (Publication No. 1747-6.15)
- *Advanced Programming Software User Manual* (Publication No. 9399-APSUM-11.15.95)

1. Set the SLC Channel 0 to **User** in the Channel 0 Configuration screen

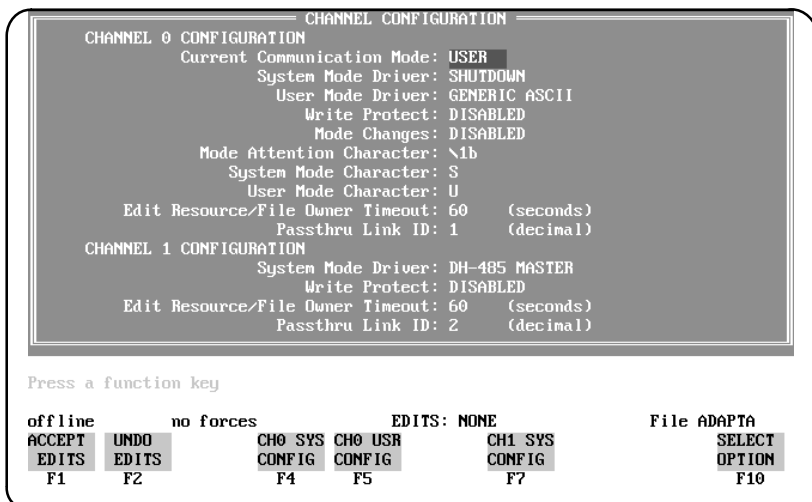

2. Configure Channel 0 in the Channel 0 User Mode Configuration screen.

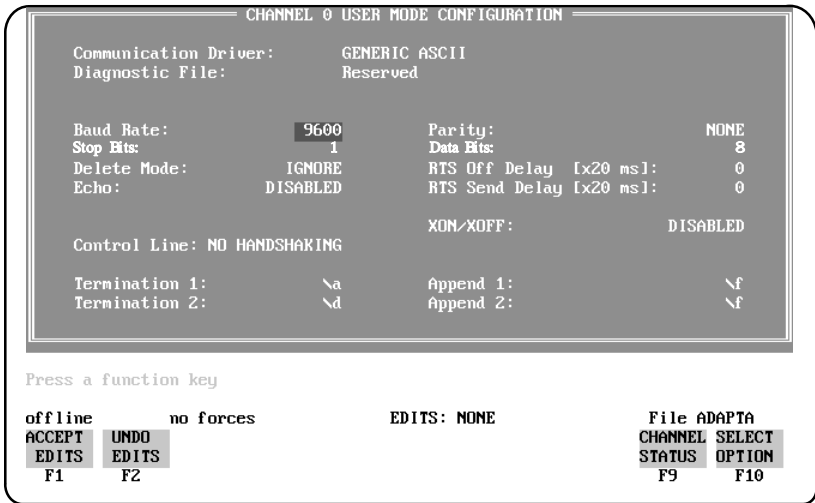

Note that Termination 1 is set for **\a** or Line Feed [**LF**], and Termination 2 is set for **\d** or Carriage Return [**CR**]. These terminators, along with the **ARL** instruction in the SLC, allow you to read one message at a time with [**CR**] [**LF**] terminators.

SLC Program

The sample ladder logic listing below instructs the SLC 5/03 and SLC 5/04 controllers to:

Rung 2:0 – Read one string of ASCII data terminated with a **[CR] [LF]**.

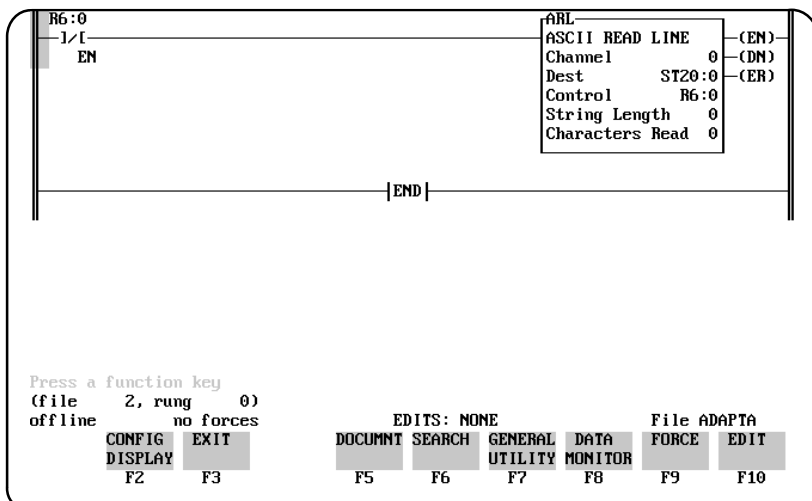

PLC-5 Controllers

This application example describes how to configure and operate the scanners when using an RS-232 cable connected to the PLC-5 controllers (Catalog Nos. 1785-L11B, 1785-L20B, 1785-L30B, 1785-L40B, 1785-L60B, and 1785-L80B).



ATTENTION: Do not install the RS-232 cable with power applied to either the base/charger unit or PLC-5 controllers. Failure to follow this caution may result in damage to the scanner, base/charger unit, or PLC-5 controllers.

Refer to the following publications for additional information.

- *Classic PLC-5 Family Programmable Controllers Hardware Installation Manual* (Publication No. 1785-6.6.1)
- *PLC-5 Programming Software Instruction Set Reference Manual* (Publication No. 6200-6.4.11)
- *PLC-5 Programming Software Configuration and Maintenance Manual* (Publication No. 6200-6.4.6)

AB PLCs

Hardware Connections for the PLC-5 Controllers

The base/charger unit connects to the PLC-5 controllers with an RS-232 cable (Catalog No. 2755-HCC-BR2-06).

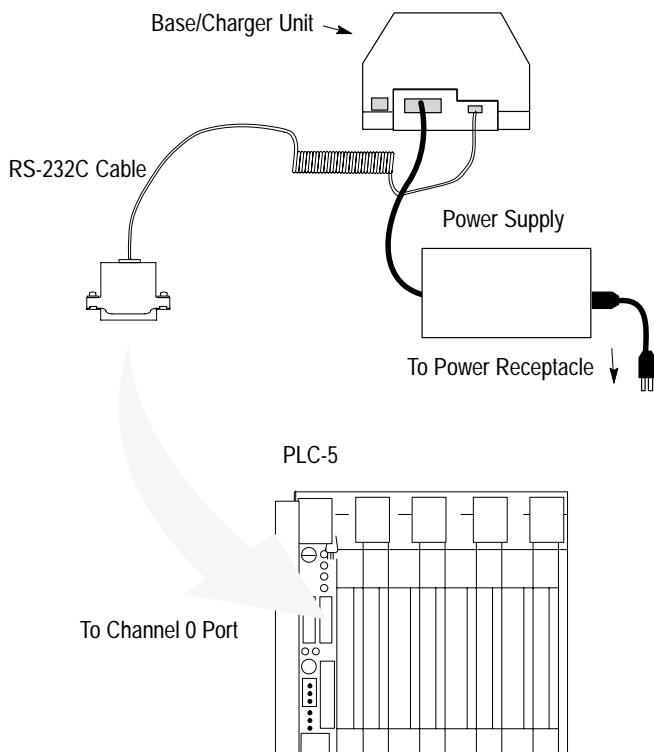

Configuration Codes for the PLC-5 Controllers

After making the necessary connections, scan bar codes starting below to set up the scanner for use with the PLC-5 controllers.

1. Scan the Set Defaults bar code.

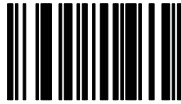

Set Defaults

2. Scan the Single Port RS-232 bar code.

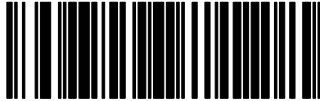

Single Port RS-232

AB PLCs

3. Scan the following bar codes.

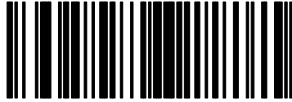

Scan Suffix (Value 1)

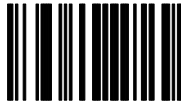

7



0



1



3

4. Scan the Data Transmission Format bar code.

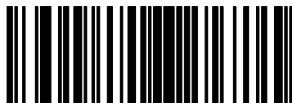

<Data><Suffix>

5. Scan the Parity bar code.



Even

The cable defaults work with the PLC-5 controllers. Your application may have specific requirements. If you change a communication setting, make sure the PLC-5 controllers are configured to accept the change.

AB PLCs

PLC-5 Controllers Setup

You need to configure the Channel 0 port of the PLC-5 controllers. Follow the steps below or refer to the following publications:

- *Classic PLC-5 Family Programmable Controllers Hardware Installation Manual* (Publication No. 1785-6.6.1)
- *PLC-5 Programming Software Instruction Set Reference Manual* (Publication No. 6200-6.4.11)
- *PLC-5 Programming Software Configuration and Maintenance Manual* (Publication No. 6200-6.4.6)

1. Set the PLC-5 Channel 0 to **User** in the Channel 0 Configuration screen.

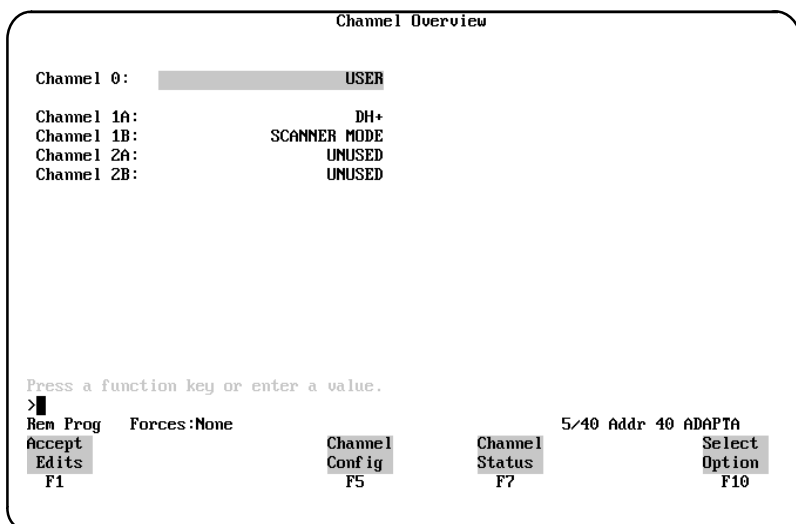

2. Configure Channel 0 in the User Mode Channel 0 Configuration screen.

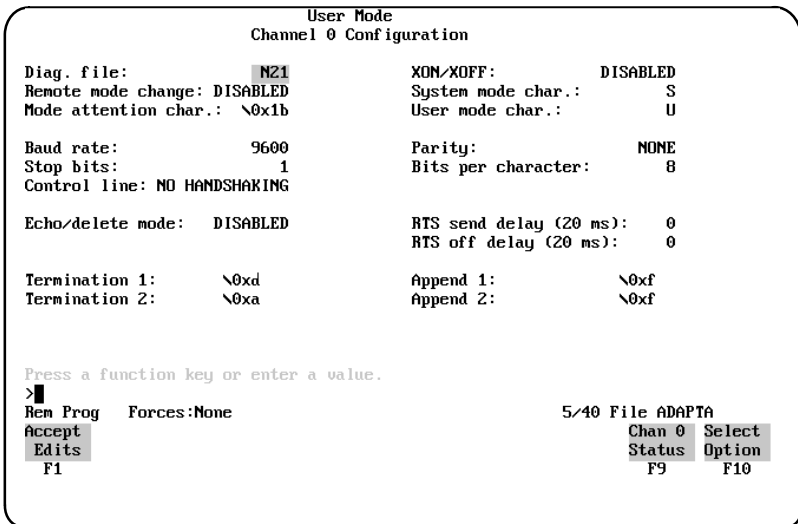

Note that Termination 1 is set for **\0xa** or Line Feed [LF], and Termination 2 is set for **\0xd** or Carriage Return [CR]. These terminators, along with the **ARL** instruction in the PLC-5 controllers, allow you to read one message at a time with [CR] [LF] terminators.

PLC Program

The sample ladder logic listing below instructs the PLC-5 controllers to:

Rung 2:0 – Read one string of ASCII data terminated with a **[CR] [LF]**.

The screenshot displays a PLC ladder logic editor interface. At the top, Rung 2:0 is shown with a normally open contact labeled 'R6:0' and an 'EN' (Enable) label. The instruction is 'ASCII READ LINE'. The parameters for this instruction are: Channel 0, Destination ST30:0 (DM), Control R6:0 (ER), String length 0 (ER), and Characters read 0. Below the instruction, the text '[END OF FILE]' is visible. At the bottom of the screen, a function key menu is displayed with the following text:

```

Press a function key.
(File 2: Rung 0) █
Rem Prog   Forces:None   Edits:None   5/40 File ADAPTA
Change    Config  Return  Program  Documnt  Search  General  Data  Force  Edit
Mode     Display to Menu  Dirctry  Search  Utility Monitor  Force  Edit
F1       F2       F3       F4       F5       F6       F7       F8       F9       F10
  
```

AdaptaScan Pass-Through

This application example describes how to configure and operate the scanners when using an RS-232 cable connected to the AdaptaScan bar code reader (Catalog Nos. 2755-SN3, 2755-SN5, and 2755-SN8).



ATTENTION: Do not install the RS-232 cable with power applied to either the base/charger unit or AdaptaScan. Failure to follow this caution may result in damage to the scanner, base/charger unit, or AdaptaScan.

Refer to the following publications for additional information.

- *AdaptaScan Bar Code Readers User Manual* (Publication No. 2755-837)
- *AdaptaScan Software User Manual* (Publication No. 2755-838)

AB PLCs

Hardware Connections for the AdaptaScan Bar Code Reader

The scanner connects to the AdaptaScan wiring base with a custom cable connected to the RS-232 cable
(Catalog No. 2755-HCC-BR1-06).

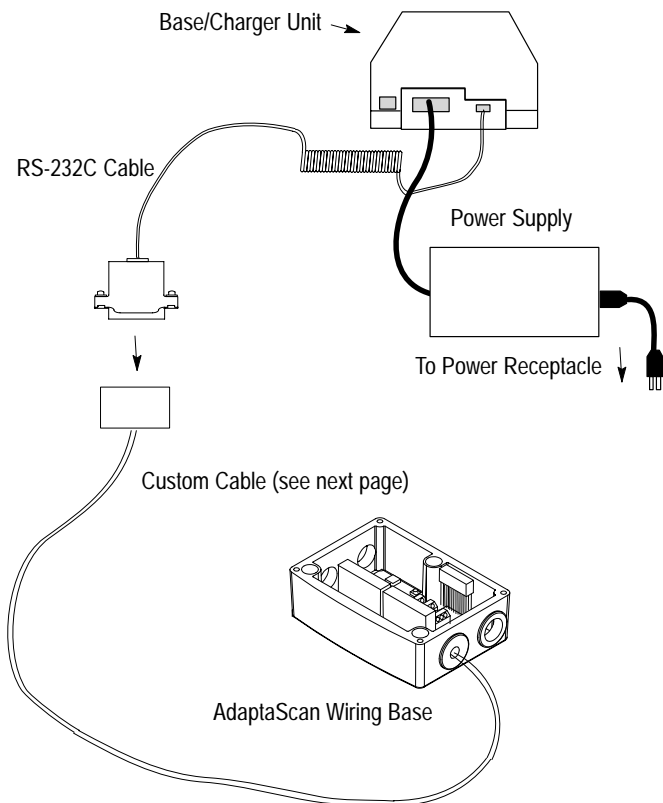

The custom cable for the AdaptaScan Pass-Through Cable connects to the RS-232 and package detect terminals in the AdaptaScan wiring base.

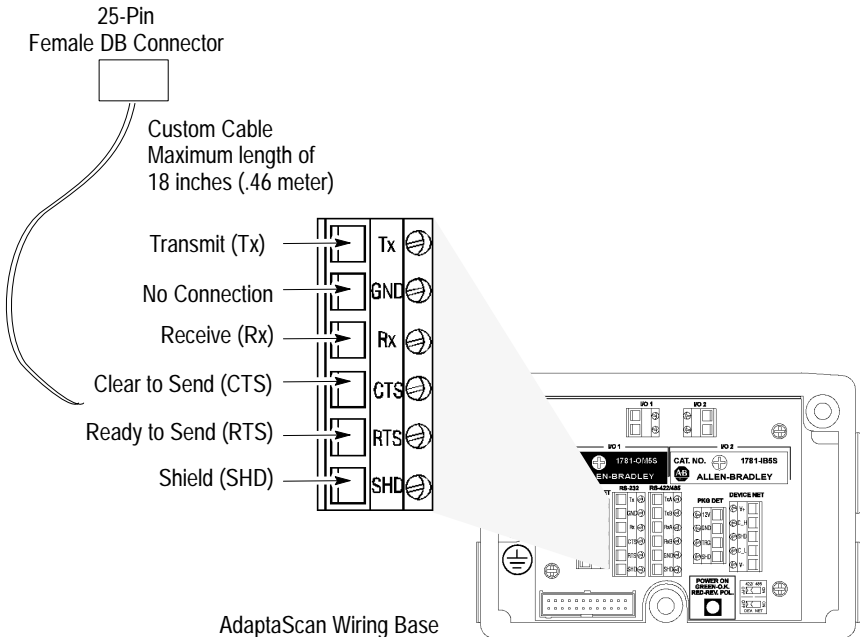

The following table provides the pinout connections for the cable (DB 25-pin female connector).

Pass-Through Cable Pin Number	Function	AdaptaScan Terminal Connection
2	Receive Data Input	Tx (RS-232 Terminal Block)
3	Transmit Data Output	Rx (RS-232 Terminal Block)
4	CTS Input	RTS (RS-232 Terminal Block)
5	RTS Output	CTS (RS-232 Terminal Block)
Shield	Shield Ground	SHD (RS-232 Terminal Block)

Configuration Codes for the AdaptaScan Bar Code Readers

After making the necessary connections, scan the bar codes starting below to set up the scanner for use with the AdaptaScan.

1. Scan the Set Defaults bar code.

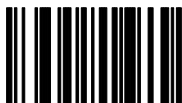

Set Defaults

2. Scan the Single Port RS-232 bar code.



Single Port RS-232

3. Scan the Parity bar code.



None

4. Scan the ASCII Format bar code.



8-bit

5. Scan the Stop Bit Select bar code.

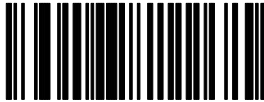

1 Stop Bit

The cable defaults work with the AdaptaScan. Your application may have specific requirements. If you change a communication setting, make sure the AdaptaScan is configured to accept the change.

AdaptaScan Bar Code Readers Setup

You may need to configure the AdaptaScan RS-232 port to accept the scanner data. Verify that the AdaptaScan serial port is configured as shown below. All settings use the default values except for the Enable Pass-Through to DeviceNet check box. Refer to the *AdaptaScan Software User Manual* (Publication No. 2755-838) for additional information.

The screenshot shows the 'Project 9 - Bar Code Reader 1 - Serial Port' configuration window. The window contains the following settings:

- Protocol:** Terminal (Default is Terminal)
- Baud Rate:** 9,600 (Default is 9600 Baud)
- Maximum Length:** 0 (Default message length is 0)
- Scanner Protocol:** (unchecked)
- Parity:** None (Default is No Parity)
- Data Bits:** 8 (Default is 8 Data)
- Stop Bits:** 1 (Default is 1 Stop Bit)
- Message Buffer:** Enable Warning (unchecked), Warning At: 56, Buffer Size: 64
- Device:** (empty field)
- Output:** (empty field)
- Connection:** RS232 (Default is RS-232 Connection)
- Enable Pass-Through to DeviceNet:** (checked)

Numbered callouts point to the following settings:

1. Default is Terminal.
2. Default is 9600 Baud.
3. Default message length is 0 (sends all data regardless of length).
4. Defaults are: No Parity, 8 Data and 1 Stop Bit.
5. Default is RS-232 Connection.
6. Enable Pass-Through.

DTAM Plus DeviceNet

This application example describes how to configure and operate the scanners when using an RS-232 cable connected to a DTAM Operator Interface (Catalog Nos. 2707-L8P1, 2707-L8P2, 2707-L40P1, 2707-L40P2, 2707-L40P4, 2707-V40P1, 2707-V40P2, or 2707-V40P2N) on a DeviceNet network.



ATTENTION: Do not install the RS-232 cable with power applied to either the base/charger unit or DTAM Operator Interface. Failure to follow this caution may result in damage to the scanner, base/charger unit, or DTAM Operator Interface.

Refer to the following publications for additional information.

- *DTAM Plus Operator Interface Module User Manual*
(Publication No. 2707-800)
- *DTAM Plus Devicenet Operator Interface Document Update*
(Publication No. 2707-800.5)
- *DTAM Programming Software Programming Manual*
(Publication No. 2707-802)
- *Getting Started with DTAM Plus User Manual*
(Publication No. 2707-802)

AB PLCs

Hardware Connections for the DTAM Plus Operator Interface

The scanners connect to the DTAM Plus Operator Interface with the RS-232 cable (Catalog No. 2755-HCC-BR1-06). You need to use a 25-9 pin connector as shown below.

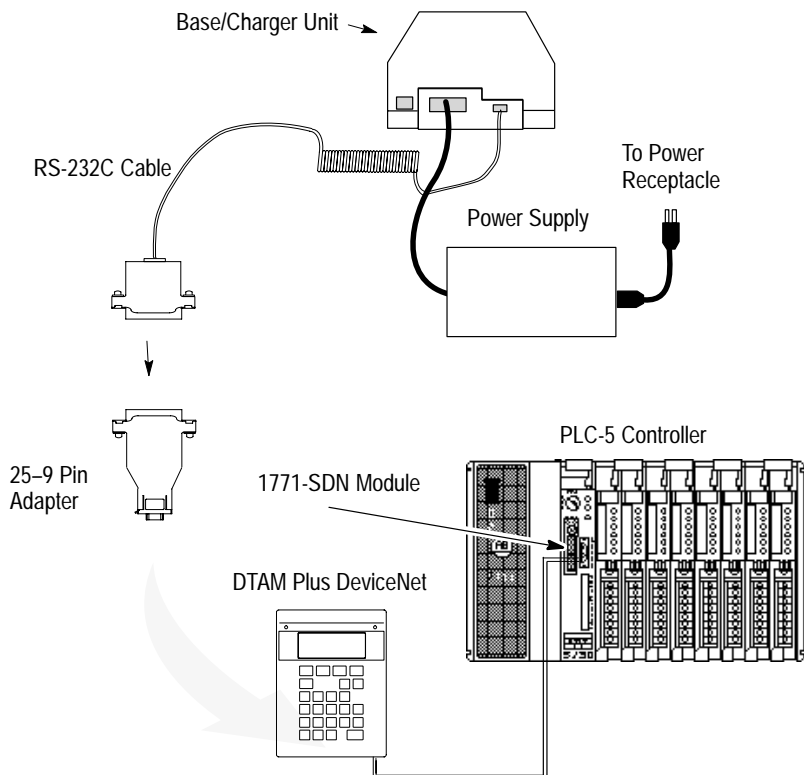

Configuration Codes for the DTAM Plus Operator Interface

After making the necessary connections, scan the bar codes starting below to set up the scanner for use with the DTAM Operator Interface.

1. Scan the Set Defaults bar code.

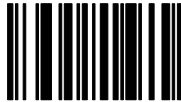

Set Defaults

2. Scan the Single Port RS-232 bar code.

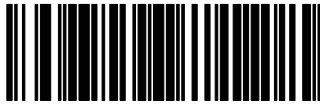

Single Port RS-232

AB PLCs

3. Scan the following bar codes.

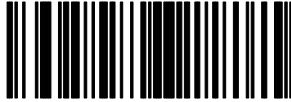

Scan Suffix (Value 1)



7



0



1



3

4. Scan the Data Transmission Format bar code.

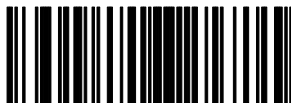

<Data><Suffix>

5. Scan the Parity bar code.



Even

The cable defaults work with the DTAM Plus Operator Interface. Your application may have specific requirements. If you change a communication setting, make sure the DTAM Plus Operator Interface is configured to accept the change.

DTAM Plus Operator Interface Setup

You may need to configure the DTAM Plus Operator Interface RS-232 port to accept the scanner data. Follow the steps below or refer to the *DTAM Programming Software Programming Manual* (Publication No. 2707-802).

1. Open Screen Builder.
2. Open Create Screen.
3. Open Data Entry Screen.
4. Select Set Up Screen.
5. Select Data Entry.
6. Select ASCII Input.
7. Set up DTAM.

AB PLCs

DeviceNet Operation

The DTAM Plus DeviceNet operates as a Group 2 Server on the DeviceNet network. It supports the Unconnected Message Manager (UCMM). The DTAM Plus DeviceNet implements the predefined master/slave connection set, operating as a slave device. It does not initiate communications except for a Duplicate Node Address check on power-up.

The DTAM Plus DeviceNet supports the polled I/O method of exchanging data with a master, in the following sequence:

1. The designated master writes an output image to the DTAM Plus DeviceNet using the Poll Command message.
2. The DTAM Plus DeviceNet responds to the poll command by returning an input image back to the master in a Poll Response message.

Note: The size of the input and output images (also referred to as files) are individually configurable from 0 words to 121 words each, to optimize DeviceNet network loading.

3. The DTAM Plus DeviceNet application program interacts with data contained in the input and output files.
4. Data Display screens are used to view input and output data.
5. Data Entry screens are used to modify input and output data from the scanner.

ASCII Table

This appendix lists the following key values:

- ASCII
- ALT
- miscellaneous
- PF
- F key
- numeric
- extended keypad

ASCII Key Values

ASCII Value	Full ASCII Code 39 Encode Char.	Keystroke	ASCII Value	Full ASCII Code 39 Encode Char.	Keystroke
1000	%U	CTRL 2	1022	\$V	CTRL V
1001	\$A	CTRL A	1023	\$W	CTRL W
1002	\$B	CTRL B	1024	\$X	CTRL X
1003	\$C	CTRL C	1025	\$Y	CTRL Y
1004	\$D	CTRL D	1026	\$Z	CTRL Z
1005	\$E	CTRL E	1027	%A	CTRL[
1006	\$F	CTRL F	1028	%B	CTRL \
1007	\$G	CTRL G	1029	%C	CTRL]
1008	\$H	CTRL H	1030	%D	CTRL 6
1009	\$I	CTRL I	1031	%E	CTRL _
1010	\$J	CTRL J	1032	SP	SP
1011	\$K	CTRL K	1033	/A	!
1012	\$L	CTRL L	1034	/B	"
1013	\$M	CTRL M	1035	/C	#
1014	\$N	CTRL N	1036	/D	\$
1015	\$O	CTRL O	1037	/E	%
1016	\$P	CTRL P	1038	/F	&
1017	\$Q	CTRL Q	1039	/G	'
1018	\$R	CTRL R	1040	/H	(
1019	\$S	CTRL S	1041	/I)
1020	\$T	CTRL T	1042	/J	*
1021	\$U	CTRL U	1043	/K	+

Table continued on the next page.

ASCII Value	Full ASCII Code 39 Encode Char.	Keystroke	ASCII Value	Full ASCII Code 39 Encode Char.	Keystroke
1044	/L	,	1069	E	E
1045	-	-	1070	F	F
1046	.	.	1071	G	G
1047	/	/	1072	H	H
1048	0	0	1073	I	I
1049	1	1	1074	J	J
1050	2	2	1075	K	K
1051	3	3	1076	L	L
1052	4	4	1077	M	M
1053	5	5	1078	N	N
1054	6	6	1079	O	O
1055	7	7	1080	P	P
1056	8	8	1081	Q	Q
1057	9	9	1082	R	R
1058	/Z	:	1083	S	S
1059	%F	;	1084	T	T
1060	%G	<	1085	U	U
1061	%H	=	1086	V	V
1062	%I	>	1087	W	W
1063	%J	?	1088	X	X
1064	%V	@	1089	Y	Y
1065	A	A	1090	Z	Z
1066	B	B	1091	%K	[
1067	C	C	1092	%L	\
1068	D	D	1093	%M]

Table continued on the next page.

ASCII Value	Full ASCII Code 39 Encode Char.	Keystroke	ASCII Value	Full ASCII Code 39 Encode Char.	Keystroke
1094	%N	^	1111	+O	o
1095	%O	_	1112	+P	p
1096	%W	'	1113	+Q	q
1097	+A	a	1114	+R	r
1098	+B	b	1115	+S	s
1099	+C	c	1116	+T	t
1100	+D	d	1117	+U	u
1101	+E	e	1118	+V	v
1102	+F	f	1119	+W	w
1103	+G	g	1120	+X	x
1104	+H	h	1121	+Y	y
1105	+I	i	1122	+Z	z
1106	+J	j	1123	%P	{
1107	+K	k	1124	%Q	
1108	+L	l	1125	%R	}
1109	+M	m	1126	%S	~
1110	+N	n	1127		Undefined

ALT Key Values

ALT Key Value	Keystroke	ALT Key Value	Keystroke	ALT Key Value	Keystroke
2064	ALT 2	2075	ALT K	2086	ALT V
2065	ALT A	2076	ALT L	2087	ALT W
2066	ALT B	2077	ALT M	2088	ALT X
2067	ALT C	2078	ALT N	2089	ALT Y
2068	ALT D	2079	ALT O	2090	ALT Z
2069	ALT E	2080	ALT P	2091	ALT [
2070	ALT F	2081	ALT Q	2092	ALT \
2071	ALT G	2082	ALT R	2093	ALT]
2072	ALT H	2083	ALT S	2094	ALT 6
2073	ALT I	2084	ALT T	2095	ALT -
2074	ALT J	2085	ALT U		

Miscellaneous Key Values

Misc. Key Value	Keystroke	Misc. Key Value	Keystroke	Misc. Key Value	Keystroke
3001	PA 1	3009	CMD 7	3017	°
3002	PA 2	3010	CMD 8	3018	½
3003	CMD 1	3011	CMD 9	3019	¶
3004	CMD 2	3012	CMD 10	3020	§
3005	CMD 3	3013	¥	3021	
3006	CMD 4	3014	£	3022	0/00
3007	CMD 5	3015	□		
3008	CMD 6	3016	-		

PF Key Values

PF Key Value	Keystroke	PF Key Value	Keystroke	PF Key Value	Keystroke
4001	PF 1	4009	PF 9	4017	PF 17
4002	PF 2	4010	PF 10	4018	PF 18
4003	PF 3	4011	PF 11	4019	PF 19
4004	PF 4	4012	PF 12	4020	PF 20
4005	PF 5	4013	PF 13	4021	PF 21
4006	PF 6	4014	PF 14	4022	PF 22
4007	PF 7	4015	PF 15	4023	PF 23
4008	PF 8	4016	PF 16	4024	PF 24

F Key Values

F Key Value	Keystroke	F Key Value	Keystroke	F Key Value	Keystroke
5001	F 1	5014	F 14	5027	F 27
5002	F 2	5015	F 15	5028	F 28
5003	F 3	5016	F 16	5029	F 29
5004	F 4	5017	F 17	5030	F 30
5005	F 5	5018	F 18	5031	F 31
5006	F 6	5019	F 19	5032	F 32
5007	F 7	5020	F 20	5033	F 33
5008	F 8	5021	F 21	5034	F 34
5009	F 9	5022	F 22	5035	F 35
5010	F 10	5023	F 23	5036	F 36
5011	F 11	5024	F 24	5037	F 37
5012	F 12	5025	F 25	5038	F 38
5013	F 13	5026	F 26	5039	F 39

Numeric Key Values

Numeric Key Value	Keystroke	Numeric Key Value	Keystroke	Numeric Key Value	Keystroke
6042	*	6049	1	6056	8
6043	+	6050	2	6057	9
6044	Undefined	6051	3	6058	Enter
6045	-	6052	4	6059	Num Lock
6046	.	6053	5	6060	00
6047	/	6054	6		
6048	0	6055	7		

Extended Keypad Key Values

Numeric Key Value	Keystroke	Numeric Key Value	Keystroke	Numeric Key Value	Keystroke
7001	Break	7008	Backspace	7015	Up Arrow
7002	Delete	7009	Tab	7016	Down Arrow
7003	Page Up	7010	Print Screen	7017	Left Arrow
7004	End	7011	Insert	7018	Right Arrow
7005	Page Down	7012	Home	7019	Back Tab
7006	Pause	7013	Enter		
7007	Scroll Lock	7014	Escape		

Numbers

- 0, 1-13, 1-21, 1-23, 1-27, 1-33,
1-36, 1-41, 1-43, A-15,
A-23, A-37
- 1, 1-13, 1-21, 1-23, 1-27, 1-33,
1-36, 1-41, 1-43, A-15,
A-23, A-37
- 2, 1-13, 1-21, 1-23, 1-27, 1-33,
1-36, 1-41, 1-43
- 3, 1-14, 1-21, 1-23, 1-27, 1-33,
1-36, 1-41, 1-43, A-15,
A-23, A-37
- 4, 1-14, 1-21, 1-23, 1-27, 1-33,
1-36, 1-41, 1-43
- 5, 1-14, 1-21, 1-24, 1-27, 1-33,
1-36, 1-41, 1-43
- 6, 1-14, 1-22, 1-24, 1-28, 1-34,
1-37, 1-42, 1-44
- 7, 1-14, 1-22, 1-24, 1-28, 1-34,
1-37, 1-42, 1-44
- 8, 1-14, 1-22, 1-24, 1-28, 1-34,
1-37, 1-42, 1-44
- 9, 1-14, 1-22, 1-24, 1-28, 1-34,
1-37, 1-42, 1-44

A

- Add Codabar, 1-9
- Add Code 128, 1-8
- Add Code 39, 1-8
- Add Code 39 Full ASCII, 1-8
- Add D 2 of 5, 1-9

- Add EAN 128, 1-9
- Add I 2 of 5, 1-9
- Add MSI Plessey, 1-10
- Add UPC/EAN, 1-8
- Advanced Data Format
 - ., 2-55
 - !, 2-55
 - ?, 2-56
 - ;, 2-56
 - ;;, 2-56
 - ”, 2-55
 - ‘, 2-55, 2-57
 - (, 2-55, 2-65
 -), 2-55, 2-65
 - [, 2-56
 -], 2-57
 - &, 2-55
 - #, 2-54
 - \$, 2-54
 - %, 2-54
 - @, 2-56
 - +, 2-54
 - , 2-54, 2-57
 - *, 2-54
 - /, 2-55
 - ^, 2-57
 - |, 2-65
 - =, 2-56
 - <F0>, 2-56
 - >, 2-56
 - \, 2-57
 - ~, 2-66
 - 0, 2-52, 2-57
 - 1, 2-5, 2-52, 2-57
 - 10, 2-6
 - 11, 2-7
 - 12, 2-7

- 13, 2-7
- 14, 2-7
- 15, 2-7
- 16, 2-7
- 17, 2-7
- 18, 2-7
- 19, 2-8
- 2, 2-5, 2-52, 2-57
- 20, 2-8
- 21, 2-8
- 22, 2-8
- 23, 2-8
- 24, 2-8
- 25, 2-8
- 26, 2-8
- 27, 2-9
- 28, 2-9
- 29, 2-9
- 3, 2-6, 2-52, 2-58
- 30, 2-9
- 4, 2-6, 2-52, 2-58
- 5, 2-6, 2-52, 2-58
- 6, 2-6, 2-53, 2-58
- 7, 2-6, 2-53, 2-58
- 8, 2-6, 2-53, 2-58
- 9, 2-6, 2-53, 2-58
- A, 2-58
- a, 2-62
- Actions, 2-3, 2-11
- Alphanumeric Keypad, 2-54
- Any Source, 2-5
- B, 2-59
- b, 2-62
- C, 2-59
- c, 2-62
- Cancel, 2-53, 2-62
- Codabar, 2-4
- Code 128, 2-4
- Code 39, 2-4
- Criteria, 2-2, 2-4
- D, 2-59
- d, 2-62
- D 2 of 5, 2-4
- E, 2-59
- e, 2-62
- EAN-13, 2-5
- EAN-8, 2-5
- End of Message, 2-62
- Erase Actions and Start Again, 2-10
- Erase All Rules, 2-10
- Erase Criteria and Start Again, 2-10
- Erase Previously Saved Rule, 2-10
- F, 2-59
- f, 2-63
- G, 2-59
- g, 2-63
- H, 2-59
- h, 2-63
- I, 2-59
- i, 2-63
- I 2 of 5, 2-4
- J, 2-60
- j, 2-63
- K, 2-60
- k, 2-63
- L, 2-60
- l, 2-63
- M, 2-60
- m, 2-63
- N, 2-60
- n, 2-64
- Numeric Keypad, 2-52
- O, 2-60
- o, 2-64
- overview, 2-1
- P, 2-60
- p, 2-64
- Q, 2-60
- q, 2-64
- Quit Entering Rules, 2-10
- R, 2-61

- r, 2-64
- Rules Hierarchy, 2-3
- S, 2-61
- s, 2-64
- Save Rule, 2-10
- Scanner Port, 2-5
- Send ., 2-22
- Send !, 2-20
- Send ?, 2-24
- Send ,, 2-22
- Send ;, 2-24
- Send :, 2-23
- Send ", 2-20
- Send ` , 2-21, 2-28
- Send (, 2-21
- Send), 2-21
- Send [, 2-28
- Send], 2-28
- Send {, 2-32
- Send }, 2-32
- Send &, 2-21
- Send #, 2-21
- Send \$, 2-21
- Send %, 2-21
- Send @, 2-24
- Send +, 2-22
- Send -, 2-22
- Send *, 2-21
- Send /, 2-22
- Send ^, 2-28
- Send |, 2-32
- Send =, 2-24
- Send <F0>, 2-24
- Send >, 2-24
- Send \, 2-28
- Send ~, 2-32
- Send _, 2-28
- Send 0, 2-22
- Send 1, 2-22
- Send 1/2 Character, 2-38
- Send 2, 2-22
- Send 3, 2-23
- Send 4, 2-23
- Send 5, 2-23
- Send 6, 2-23
- Send 7, 2-23
- Send 8, 2-23
- Send 9, 2-23
- Send A, 2-24
- Send a, 2-28
- Send Account Number, 2-14
- Send All Data That Remains,
2-11
- Send Alt [, 2-35
- Send Alt], 2-36
- Send Alt -, 2-36
- Send Alt \, 2-36
- Send Alt 2, 2-32
- Send Alt 6, 2-36
- Send Alt A, 2-32
- Send Alt B, 2-32
- Send Alt C, 2-32
- Send Alt D, 2-33
- Send Alt E, 2-33
- Send Alt F, 2-33
- Send Alt G, 2-33
- Send Alt H, 2-33
- Send Alt I, 2-33
- Send Alt J, 2-33
- Send Alt K, 2-33
- Send Alt L, 2-34
- Send Alt M, 2-34
- Send Alt N, 2-34
- Send Alt O, 2-34
- Send Alt P, 2-34
- Send Alt Q, 2-34
- Send Alt R, 2-34
- Send Alt S, 2-34
- Send Alt T, 2-35
- Send Alt U, 2-35
- Send Alt V, 2-35
- Send Alt W, 2-35
- Send Alt X, 2-35
- Send Alt Y, 2-35

- Send Alt Z, 2-35
- Send B, 2-24
- Send b, 2-28
- Send Back Tab Character, 2-43
- Send Backspace Key, 2-42
- Send Bomb Character, 2-38
- Send Break Key, 2-41
- Send Bullet Character, 2-38
- Send C, 2-25
- Send c, 2-29
- Send CMD 1, 2-36
- Send CMD 10, 2-37
- Send CMD 2, 2-36
- Send CMD 3, 2-37
- Send CMD 4, 2-37
- Send CMD 5, 2-37
- Send CMD 6, 2-37
- Send CMD 7, 2-37
- Send CMD 8, 2-37
- Send CMD 9, 2-37
- Send Control [, 2-20
- Send Control], 2-20
- Send Control -, 2-20
- Send Control \, 2-20
- Send Control 2, 2-16
- Send Control 6, 2-20
- Send Control A, 2-16
- Send Control B, 2-16
- Send Control C, 2-17
- Send Control D, 2-17
- Send Control E, 2-17
- Send Control F, 2-17
- Send Control G, 2-17
- Send Control H, 2-17
- Send Control I, 2-17
- Send Control J, 2-17
- Send Control K, 2-18
- Send Control L, 2-18
- Send Control M, 2-18
- Send Control N, 2-18
- Send Control O, 2-18
- Send Control P, 2-18
- Send Control Q, 2-18
- Send Control R, 2-18
- Send Control S, 2-19
- Send Control T, 2-19
- Send Control U, 2-19
- Send Control V, 2-19
- Send Control W, 2-19
- Send Control X, 2-19
- Send Control Y, 2-19
- Send Control Z, 2-19
- Send Customer Name, 2-14
- Send D, 2-25
- Send d, 2-29
- Send Delete Key, 2-41
- Send Discretionary Data, 2-15
- Send Down Arrow Key, 2-43
- Send E, 2-25
- Send e, 2-29
- Send End Key, 2-41
- Send Enter Key, 2-42
- Send Escape Key, 2-42
- Send Exp Date (MMYY), 2-14
- Send Exp Date (YYMM), 2-14
- Send F, 2-25
- Send f, 2-29
- Send F1 Key, 2-43
- Send F10 Key, 2-44
- Send F11 Key, 2-44
- Send F12 Key, 2-45
- Send F13 Key, 2-45
- Send F14 Key, 2-45
- Send F15 Key, 2-45
- Send F16 Key, 2-45
- Send F17 Key, 2-45
- Send F18 Key, 2-45
- Send F19 Key, 2-45
- Send F2 Key, 2-43
- Send F20 Key, 2-46
- Send F21 Key, 2-46
- Send F22 Key, 2-46
- Send F23 Key, 2-46
- Send F24 Key, 2-46

- Send F25 Key, 2-46
- Send F26 Key, 2-46
- Send F27 Key, 2-46
- Send F28 Key, 2-47
- Send F29 Key, 2-47
- Send F3 Key, 2-43
- Send F30 Key, 2-47
- Send F4 Key, 2-44
- Send F5 Key, 2-44
- Send F6 Key, 2-44
- Send F7 Key, 2-44
- Send F8 Key, 2-44
- Send F9 Key, 2-44
- Send G, 2-25
- Send g, 2-29
- Send H, 2-25
- Send h, 2-29
- Send Home Key, 2-42
- Send Hook Character, 2-38
- Send I, 2-25
- Send i, 2-29
- Send Insert Key, 2-42
- Send J, 2-25
- Send j, 2-29
- Send K, 2-26
- Send k, 2-30
- Send Keypad ., 2-39
- Send Keypad +, 2-39
- Send Keypad -, 2-39
- Send Keypad *, 2-39
- Send Keypad /, 2-39
- Send Keypad 0, 2-39
- Send Keypad 1, 2-39
- Send Keypad 2, 2-40
- Send Keypad 3, 2-40
- Send Keypad 4, 2-40
- Send Keypad 5, 2-40
- Send Keypad 6, 2-40
- Send Keypad 7, 2-40
- Send Keypad 8, 2-40
- Send Keypad 9, 2-40
- Send Keypad Enter, 2-41
- Send Keypad Num Lock, 2-41
- Send L, 2-26
- Send l, 2-30
- Send Left Arrow Key, 2-43
- Send M, 2-26
- Send m, 2-30
- Send N, 2-26
- Send n, 2-30
- Send Next 10 Characters, 2-13
- Send Next 11 Characters, 2-13
- Send Next 12 Characters, 2-13
- Send Next 13 Characters, 2-13
- Send Next 14 Characters, 2-13
- Send Next 15 Characters, 2-13
- Send Next 16 Characters, 2-13
- Send Next 17 Characters, 2-13
- Send Next 18 Characters, 2-14
- Send Next 19 Characters, 2-14
- Send Next 2 Characters, 2-12
- Send Next 20 Characters, 2-14
- Send Next 3 Characters, 2-12
- Send Next 4 Characters, 2-12
- Send Next 5 Characters, 2-12
- Send Next 6 Characters, 2-12
- Send Next 7 Characters, 2-12
- Send Next 8 Characters, 2-12
- Send Next 9 Characters, 2-12
- Send Next Character, 2-11
- Send O, 2-26
- Send o, 2-30
- Send P, 2-26
- Send p, 2-30
- Send PA 1, 2-36
- Send PA 2, 2-36
- Send Page Down Key, 2-41
- Send Page Up Key, 2-41
- Send Paragraph Character, 2-38
- Send Pause, 2-11
- Send Pause Key, 2-41
- Send PF1 Key, 2-47
- Send PF10 Key, 2-48
- Send PF11 Key, 2-48

- Send PF12 Key, 2-48
- Send PF13 Key, 2-48
- Send PF14 Key, 2-49
- Send PF15 Key, 2-49
- Send PF16 Key, 2-49
- Send PF17 Key, 2-49
- Send PF18 Key, 2-49
- Send PF19 Key, 2-49
- Send PF2 Key, 2-47
- Send PF20 Key, 2-49
- Send PF21 Key, 2-49
- Send PF22 Key, 2-50
- Send PF23 Key, 2-50
- Send PF24 Key, 2-50
- Send PF25 Key, 2-50
- Send PF26 Key, 2-50
- Send PF27 Key, 2-50
- Send PF28 Key, 2-50
- Send PF29 Key, 2-50
- Send PF3 Key, 2-47
- Send PF30 Key, 2-51
- Send PF4 Key, 2-47
- Send PF5 Key, 2-47
- Send PF6 Key, 2-48
- Send PF7 Key, 2-48
- Send PF8 Key, 2-48
- Send PF9 Key, 2-48
- Send Pound Sterling Character,
2-38
- Send Print Screen Key, 2-42
- Send Q, 2-26
- Send q, 2-30
- Send R, 2-26
- Send r, 2-30
- Send Right Arrow Key, 2-43
- Send S, 2-27
- Send s, 2-31
- Send Scroll Lock Key, 2-42
- Send Section Character, 2-38
- Send Space, 2-20
- Send T, 2-27
- Send t, 2-31
- Send Tab Key, 2-42
- Send Track 1 Data, 2-14
- Send Track 2 Data, 2-15
- Send Track 3 Data, 2-15
- Send U, 2-27
- Send u, 2-31
- Send Up Arrow Key, 2-43
- Send V, 2-27
- Send v, 2-31
- Send Value 1, 2-11
- Send Value 2, 2-11
- Send Value 3, 2-11
- Send Value 4, 2-11
- Send Vertical Character, 2-39
- Send W, 2-27
- Send w, 2-31
- Send X, 2-27
- Send x, 2-31
- Send Y, 2-27
- Send y, 2-31
- Send Yen Character, 2-38
- Send Z, 2-27
- Send z, 2-31
- Skip Ahead 1 Character, 2-15
- Skip Ahead 10 Characters, 2-16
- Skip Ahead 2 Characters, 2-15
- Skip Ahead 3 Characters, 2-15
- Skip Ahead 4 Characters, 2-15
- Skip Ahead 5 Characters, 2-15
- Skip Ahead 6 Characters, 2-16
- Skip Ahead 7 Characters, 2-16
- Skip Ahead 8 Characters, 2-16
- Skip Ahead 9 Characters, 2-16
- Space, 2-54
- Special Commands, 2-10
- T, 2-61
- t, 2-64
- U, 2-61
- u, 2-64
- UPC-A, 2-4
- UPC-E, 2-5
- UPC/EAN, 2-5

V, 2-61
 v, 2-65
 W, 2-61
 w, 2-65
 X, 2-61
 x, 2-65
 Y, 2-61
 y, 2-65
 Z, 2-62
 z, 2-65
 Application Examples
 AdaptaScan Pass-Through,
 A-28
 DTAM Plus DeviceNet, A-34
 Enhanced Decoder, A-2
 Flexible Interface Module, A-6
 overview, A-1
 PLC-5 Controllers, A-20
 SLC 5/03 and SLC 5/04
 Controllers, A-12
 ASCII Format
 7-bit, 1-35
 8-bit, 1-35, A-5, A-9, A-32
 Audience, Intended, P-1
 Autodiscriminate UPC/EAN
 Supplementals, 1-16

B

Baud Rate
 110, 1-29
 1200, 1-29
 19200, 1-29
 2400, 1-29
 300, 1-29
 4800, 1-29
 600, 1-29
 9600, 1-29
 Beep After Good Decode, 1-18

Bi-directional Redundancy
 Disabled, 1-18
 Bi-directional Redundancy
 Enabled, 1-18
 Buffer Code 39, 1-17

C

Cancel, 1-14, 1-22, 1-24, 1-28,
 1-34, 1-37, 1-42, 1-44
 Check Parity, 1-31
 Codabar - 1 Discrete Length ,
 1-11
 Codabar - 2 Discrete Lengths ,
 1-11
 Codabar - Any Length, 1-11
 Codabar - Length Within Range,
 1-11
 Code 128 - Any Length, 1-11
 Code 39 - 1 Discrete Length ,
 1-10
 Code 39 - 2 Discrete Lengths ,
 1-11
 Code 39 - Any Length, 1-10
 Code 39 - Length Within Range,
 1-10
 Code Lengths, 1-10
 Code Types, 1-7
 Contents of this Manual, P-1
 Convert UPC-E to UPC-A, 1-16

D

D 2 of 5 – 1 Discrete Length ,
 1–12
 D 2 of 5 – 2 Discrete Lengths ,
 1–12
 D 2 of 5 – Any Length , 1–12
 D 2 of 5 – Length Within Range,
 1–12
 Data Transmission Formats, 1–25
 DEC VT 2xx/3xx/4xx, 1–7
 Decode Options, 1–15
 Decode Redundancy 1, 1–19
 Decode Redundancy 2, 1–19
 Decode Redundancy 3, 1–19
 Decode UPC/EAN Supplementals,
 1–16
 default settings, 1–4
 Delete Codabar, 1–10
 Delete Code 128, 1–8
 Delete Code 39, 1–8
 Delete Code 39 Full ASCII, 1–8
 Delete D 2 of 5, 1–9
 Delete EAN 128, 1–9
 Delete I 2 of 5, 1–9
 Delete MSI Plessey, 1–10
 Delete UPC/EAN, 1–8
 Disable All Code types, 1–7
 Disable EAN Zero Extend, 1–16
 Do Not Beep After Good Decode,
 1–18
 Do Not Buffer Code 39, 1–17

Do Not Check Parity, 1–31
 Do Not Convert UPC–E to
 UPC–A, 1–16
 Do Not Transmit AIM Code ID,
 1–38
 Do Not Transmit Code ID
 Character, 1–37
 Do Not Transmit No Decode
 Message, 1–17
 Do Not Transmit UPC–A Check
 Digit, 1–15
 Do Not Transmit UPC–E Check
 Digit, 1–15
 Do Not Verify Code 39 Check
 Digit, 1–18

E

Enable 1 MSI Plessey Check Digit,
 1–15
 Enable 2 MSI Plessey Check Digits,
 1–15
 Enable All Code types, 1–7
 Enable EAN Zero Extend, 1–16

H

Hardware Handshaking
 None, 1–31
 RTS/CTS, 1–31
 High Beeper Volume, 1–18
 Host Interface Code, 1–7

AB PLCs

I

- I 2 of 5 – 1 Discrete Length , 1–12
- I 2 of 5 – 2 Discrete Lengths , 1–12
- I 2 of 5 – Any Length, 1–11
- I 2 of 5 – Length Within Range,
1–12
- IBM PC/AT PS2–50, –55sx, –60,
–70, –80, and Clones, 1–7
- IBM PC/XT and Clones, 1–7
- IBM PS2–30 and Clones, 1–7
- Ignore Unknown Characters
 - Disable, 1–38
 - Enable, 1–38
- Ignore UPC/EAN Supplementals,
1–16
- Intended Audience, P–1
- Intercharacter Delay, 1–36
- International Keyboard Emulation
 - Disable, 1–39
 - Enable, 1–39
- International Keyboard Emulation
 - Fast Transmit
 - Disable, 1–39
 - Enable, 1–39
- ITF 14/EAN–13 Conversion
 - Disabled, 1–17
- ITF 14/EAN–13 Conversion
 - Enabled, 1–17

K

- key values
 - ALT, B–5
 - ASCII, B–2
 - extended keypad, B–7

- F, B–6
- miscellaneous, B–5
- numeric, B–7
- PF, B–6

L

- Laser On Time–Out, 1–27
- Low Beeper Volume, 1–18

M

- MSI Plessey – 1 Discrete Length ,
1–13
- MSI PLESsey – 2 Discrete Lengths ,
1–13
- MSI Plessey – 2 Discrete Lengths ,
1–13
- MSI Plessey – Any Length , 1–13
- MSI Plessey – Length Within
Range, 1–13

N

- National Keyboard Types
 - French, 1–40
 - French International, 1–40
 - German, 1–40
 - Italian, 1–40
 - Spanish, 1–40
 - Swedish, 1–40
 - UK English, 1–40

P

Parity
 Even, 1-30, A-16, A-24, A-38
 Mark, 1-30
 None, 1-30, A-4, A-8, A-31
 Space, 1-30

Pause Duration, 1-21

Prefix and Suffix, 1-23

publication, related, P-2

R

Related Publications, P-2

RTS Line State
 Line High, 1-35
 Line Low, 1-35

S

Serial Response Time-Out, 1-33

Set Defaults, 1-4, A-4, A-8,
 A-14, A-22, A-31, A-36

Set Transmission Frequency, 1-41

Single Port RS-232, 1-7, A-4,
 A-8, A-14, A-22, A-31,
 A-36

Software Handshaking
 ACK/NAK, 1-32
 ACK/NAK with ENQ, 1-32
 ENQ Only, 1-32
 None, 1-32

Stop Bit Select
 1 Stop Bit, 1-34, A-5, A-32
 2 Stop Bits, 1-34

T

Transmit AIM Code ID, 1-38

Transmit Code ID Character, 1-37

Transmit No Decode Message,
 1-17

Transmit UPC-A Check Digit,
 1-15

Transmit UPC-E Check Digit,
 1-15

U

UPC-A Preamble
 None, 1-20
 System Character, 1-20
 System Character and Country
 Code, 1-20

UPC-E Preamble
 None, 1-20
 System Character, 1-20
 System Character and Country
 Code, 1-20

UPC/EAN Security Level 0, 1-19

UPC/EAN Security Level 1, 1-19

UPC/EAN Security Level 2, 1-19

UPC/EAN Security Level 3, 1-19

V

Verify Code 39 Check Digit, 1-17

AB PLCs

W

Wait for Host Interface Response
Time, 1-43

TEST SYMBOLS



1 2 3 4 5

Code 128

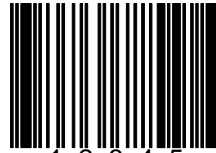

1 2 3 4 5

Code 93



A 1 2 3 4 B

Codabar



A 1 2 3 4 B

Code 39

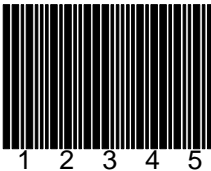

1 2 3 4 5

Discrete 2 of 5



1 2 3 4 5

EAN 128



1 234567 891019

EAN 13



1234 5670

EAN 8

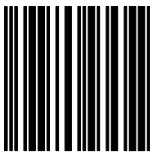

0 1 2 3 4 5

Interleaved 2 of 5



1 23456 78901 2

UPC A

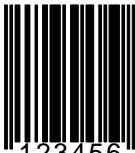

0 123456 5

UPC E

AB PLCs

 **Rockwell** Automation

Allen-Bradley

Worldwide representation.



Argentina • Australia • Austria • Bahrain • Belgium • Brazil • Bulgaria • Canada • Chile • China, PRC • Colombia • Costa Rica • Croatia • Cyprus • Czech Republic • Denmark • Ecuador • Egypt • El Salvador • Finland • France • Germany • Greece • Guatemala • Honduras • Hong Kong • Hungary • Iceland • India • Indonesia • Ireland • Israel • Italy • Jamaica • Japan • Jordan • Korea • Kuwait • Lebanon • Malaysia • Mexico • Netherlands • New Zealand • Norway • Pakistan • Peru • Philippines • Poland • Portugal • Puerto Rico • Qatar • Romania • Russia–CIS • Saudi Arabia • Singapore • Slovakia • Slovenia • South Africa, Republic • Spain • Sweden • Switzerland • Taiwan • Thailand • Turkey • United Arab Emirates • United Kingdom • United States • Uruguay • Venezuela • Yugoslavia

Allen-Bradley Headquarters, 1201 South Second Street, Milwaukee, WI 53204 USA, Tel: (1) 414 382-2000 Fax: (1) 414 382-4444