

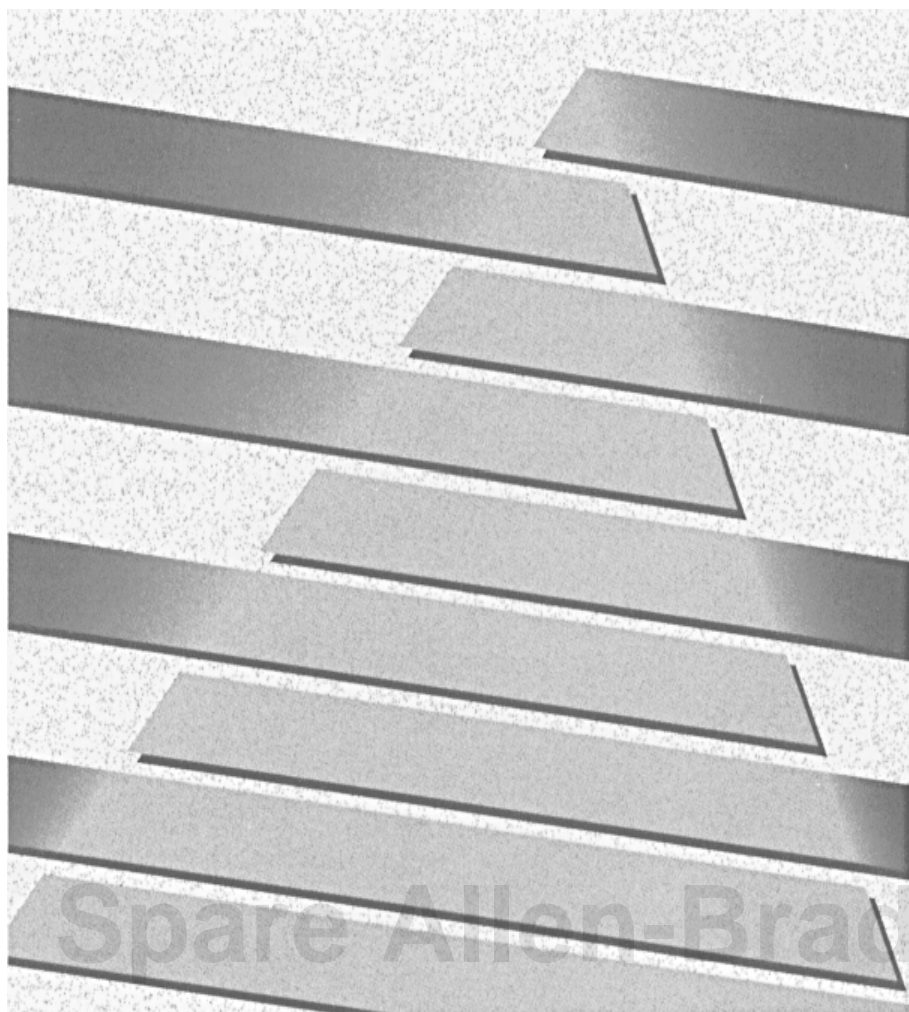

ALLEN-BRADLEY

**Bulletin 2755**  
**Hand-Held Scanner**  
**with Wedge Option**  
(Catalog No. 2755-G3-W, 2755-G6-W)

User Manual



## Important User Information

Solid state equipment has operational characteristics differing from those of electromechanical equipment. "Application Guidelines for Application, Installation, and Maintenance of Solid State Controls" (Publication SGI-1.1) describes some important differences between solid state equipment and hard-wired electromechanical devices. Because of this difference, and also because of the wide variety of uses for solid state equipment, all persons responsible for applying this equipment must satisfy themselves that each intended application of this equipment is acceptable.

In no event will the Allen-Bradley Company be responsible or liable for indirect or consequential damages resulting from the use or application of this equipment.

The examples and diagrams in this manual are included solely for illustrative purposes. Because of the many variables and requirements associated with any particular installation, the Allen-Bradley Company cannot assume responsibility or liability for actual use based on the examples and diagrams.

No patent liability is assumed by Allen-Bradley Company with respect to use of information, circuits, equipment, or software described in this manual.

Reproduction of the contents of this manual, in whole or in part, without written permission of the Allen-Bradley Company is prohibited.

Compaq is a registered trademark of Compaq Computer Corporation.  
DEC and VT are registered trademarks of Digital Equipment Corporation.  
Hewlett-Packard is a registered trademark of Hewlett-Packard Company.  
IBM is a registered trademark of International Business Machines Corporation  
PC AT, PS/2 and PC XT are trademarks of International Business Machines Corporation  
PHOTOSWITCH is a registered trademark of Allen-Bradley Company, Inc.

**Using  
this Manual**

**Chapter 1**

|                                   |     |
|-----------------------------------|-----|
| Chapter Objectives .....          | 1-1 |
| Contents of Package .....         | 1-1 |
| Intended Audience .....           | 1-1 |
| Overview of Manual .....          | 1-2 |
| Warning and Caution Symbols ..... | 1-3 |
| Related Publications .....        | 1-3 |

**Overview  
of Scanner**

**Chapter 2**

|                           |     |
|---------------------------|-----|
| Chapter Objectives .....  | 2-1 |
| Function of Scanner ..... | 2-1 |
| Operating Modes .....     | 2-2 |
| Hand-Held Mode .....      | 2-2 |
| Autosense Mode .....      | 2-2 |
| Setup Parameters .....    | 2-3 |
| Keyboard Wedge .....      | 2-3 |
| General Setup .....       | 2-3 |
| Message Format .....      | 2-4 |
| Symbology .....           | 2-4 |
| Ordering a Scanner .....  | 2-5 |
| Scanner Accessories ..... | 2-6 |

**Using  
the Scanner**

**Chapter 3**

|                            |     |
|----------------------------|-----|
| Chapter Objectives .....   | 3-1 |
| Physical Description ..... | 3-1 |
| LED Indicators .....       | 3-2 |
| Safety Labels .....        | 3-3 |
| Scanning Ranges .....      | 3-4 |
| Operating Scanner .....    | 3-6 |
| Beep .....                 | 3-7 |
| Operating Tips .....       | 3-7 |
| Troubleshooting .....      | 3-8 |

**Setup  
Instructions**

**Chapter 4**

|  |      |
|--|------|
| Chapter Objectives .....                 | 4-1  |
| Installing Wedge Interface .....         | 4-1  |
| Connecting Scanner Interface Cable ..... | 4-2  |
| Removing Scanner Interface Cable .....   | 4-3  |
| Connecting Wedge Interface Cable .....   | 4-4  |
| Connecting Optional Power Supply .....   | 4-5  |
| Terminal Power Up Sequence .....         | 4-5  |
| Enabling Wedge Mode .....                | 4-6  |
| Selecting a Terminal Type .....          | 4-6  |
| Scanner Configuration Guidelines .....   | 4-8  |
| Scanner Default Settings .....           | 4-10 |
| Resetting Factory Defaults .....         | 4-12 |

**General  
Setup  
Parameters**

**Chapter 5**

|                          |     |
|--------------------------|-----|
| Chapter Objectives ..... | 5-1 |
| System Status .....      | 5-1 |
| Power Consumption .....  | 5-3 |
| Beeper Operation .....   | 5-4 |
| Capture Count .....      | 5-5 |
| Spotter Beam .....       | 5-6 |
| Autosense Mode .....     | 5-7 |

**Message  
Format  
Parameters**

**Chapter 6**

|                             |      |
|-----------------------------|------|
| Chapter Objectives .....    | 6-1  |
| Message Format .....        | 6-1  |
| Prefix .....                | 6-2  |
| Suffix .....                | 6-3  |
| Scanner Identifier .....    | 6-4  |
| Code Identifier .....       | 6-5  |
| Preamble or Postamble ..... | 6-6  |
| Preamble .....              | 6-7  |
| Postamble .....             | 6-7  |
| Intercharacter Delay .....  | 6-10 |

**Symbologies**

**Chapter 7**

|                                      |      |
|--------------------------------------|------|
| Chapter Objectives .....             | 7-1  |
| Label Lengths .....                  | 7-1  |
| Code 39 .....                        | 7-2  |
| Modulo 43 Check Character .....      | 7-3  |
| Transmit Stop/Start Characters ..... | 7-3  |
| Minimum Length .....                 | 7-4  |
| Maximum Length .....                 | 7-4  |
| UPC (A and E) .....                  | 7-5  |
| Supplements .....                    | 7-5  |
| Expanded UPC-E .....                 | 7-5  |
| Transmit Number System Digit .....   | 7-6  |
| Transmit Check Digit .....           | 7-6  |
| UPC to EAN Translation .....         | 7-7  |
| EAN/JAN .....                        | 7-8  |
| Supplements .....                    | 7-8  |
| Transmit Number System Digit .....   | 7-9  |
| Transmit Check Digit .....           | 7-9  |
| Interleaved 2 of 5 .....             | 7-10 |
| Check Digit .....                    | 7-10 |
| Minimum Length .....                 | 7-11 |
| Maximum Length .....                 | 7-11 |
| Standard 2 of 5 .....                | 7-12 |
| Minimum Length .....                 | 7-12 |
| Maximum Length .....                 | 7-12 |
| Code 128 .....                       | 7-13 |
| Minimum Length .....                 | 7-13 |
| Maximum Length .....                 | 7-13 |
| Codabar .....                        | 7-14 |
| Transmit Stop/Start Characters ..... | 7-14 |
| Minimum Length .....                 | 7-15 |
| Maximum Length .....                 | 7-15 |

**Specifications Chapter 8**

**Appendix A Bar Code Test Symbols**

**Appendix B Digit Selection Symbols**

**Appendix C Autosense Mode**

**Appendix D Maintenance**

**Appendix E Scanner Parameters**

**Glossary**

**Index**

**Figures**

|            |  |     |
|------------|--|-----|
| <b>3.1</b> | Scanning Ranges .....                      | 3-5 |
| <b>4.1</b> | Keyboard Wedge Interface Connections ..... | 4-1 |
| <b>4.2</b> | Connecting Scanner Interface Cable .....   | 4-2 |
| <b>4.3</b> | Removing Scanner Interface Cable .....     | 4-3 |
| <b>C.1</b> | Autosense Mode .....                       | C-2 |

**Tables**

|            |  |      |
|------------|--|------|
| <b>2.A</b> | Wedge Interface Cables .....                 | 2-6  |
| <b>2.B</b> | Scanner Accessories .....                    | 2-6  |
| <b>3.A</b> | LED Indicators .....                         | 3-2  |
| <b>3.B</b> | Scanning Ranges: Standard/Long Range Scanner | 3-4  |
| <b>4.A</b> | Scanner Default Settings .....               | 4-10 |
| <b>6.A</b> | Code Identifier Characters .....             | 6-5  |
| <b>6.B</b> | Hexadecimal Conversion Table .....           | 6-8  |

## Using this Manual

### Chapter Objectives

This chapter gives an overview of the manual including:

- Contents of Package
- Intended Audience
- Overview of Manual
- Warnings and Cautions
- Related Publications

### Contents of Package

You should receive the following items when ordering the Catalog No. 2755-G3-W or 2755-G6-W Scanner:

- Scanner
- Scanner Holder
- User Manual

### Intended Audience

No special knowledge is required to install, configure, or operate the scanners as a keyboard wedge interface. However, this manual does not tell you how to use or generate an application program to receive and store the data.



## Overview of Manual

This manual shows how to set up and use the scanner as a keyboard wedge interface for non-contact scanning applications. The contents of each chapter are:

| <b>Chapter</b> | <b>Title</b>              | <b>Purpose</b>  |
|----------------|---------------------------|---|
| 1              | Using this Manual         | Provides an overview of this manual.  |
| 2              | Overview of Scanner       | Gives an overview of scanner functions, operating modes, and scanner setup parameters.  |
| 3              | Using the Scanner         | Provides basic instructions on how to use the scanner for non-contact scanning.   |
| 4              | Setup Instructions        | Shows how to setup the scanner as a keyboard wedge interface and configure the operating parameters of the scanner.   |
| 5              | General Setup Parameters  | Covers parameters specific to the operation of the scanner including beeper, power consumption, and capture count. Parameters are selected by scanning bar code labels. |
| 6              | Message Format Parameters | Covers parameters that control the format of messages transmitted to the host computer or terminal. Parameters are selected by scanning bar codes.                      |
| 7              | Symbologies               | Covers parameters that enable bar code symbologies the scanner is capable of reading. Symbologies are disabled or enabled by scanning bar codes.                        |
| 8              | Specifications            | Details specifications of the scanners.   |

## Warning and Caution Symbols

This manual contains the following caution and warning symbols.



**CAUTION:**

A laser caution symbol that appears where laser light is present.

---



**WARNING:**

A warning symbol means people might be injured if procedures are not followed.

---



**CAUTION:**

A caution symbol is used when equipment may be damaged if procedures are not followed.

---

## Related Publications

Below is a list of related publications you may need to refer to when using the scanners.

- **Publication No. 2755-921**  
Bar Code Basics  
Describes bar code symbologies, equipment, and typical applications.
- **Publication No. 2755-2.44**  
Product Data for the family of  
Visible Laser Diode Hand-Held Scanners

## Overview of Scanner

### Chapter Objectives

This chapter gives an overview of the scanner including:

- Function of Scanner
- Operating Modes
- Scanner Setup Parameters
- Scanner Accessories

### Function of Scanner

The scanner is a *keyboard wedge interface* that is capable of scanning, decoding, and transmitting bar code data to a host computer or terminal.

As a keyboard wedge interface you can use the scanner with most manufacturer's terminals. The scanner connects between the keyboard and display of the terminal. In this mode the scanner draws power directly from the terminal.

The wedge translates scanned data so that it appears as if it was entered at the keyboard. When the wedge is transmitting scanned data, the computer ignores data entered at the keyboard.

You configure the scanner for keyboard wedge mode by modifying scanner setup parameters. Parameters are selected based on the terminal type and the types of bar codes used in your application.

The scanner is easily configured by scanning the appropriate bar code labels in Chapters 4 through 7 of this manual. When a configuration label is scanned, the scanner sends a 1 or 2 line acknowledgement message to your terminal display.

**Important:** It is your responsibility to provide the appropriate application program on the host computer/terminal to receive and store the data.

## Operating Modes

The scanner functions in one of two operating modes: Hand-Held Mode or Autosense Mode.

### Hand-Held Mode

In hand-held mode, you hold the scanner in your hand and press the trigger every time you want to scan a bar code symbol.

Chapter 3 provides details on using the scanner in hand-held mode.

### Autosense Mode

In this mode the scanner operates in an optional Autostand (Catalog No. 2755-NS2) for hands-free operation. The scanner uses a low level laser beam as an internal object sensor.

When the scanner is placed in the stand it becomes immediately active for reading any bar code label presented to it. The scanner is triggered when a bar code label breaks the scan beam path (between the reflector on the stand and the scanner).

You also have the option of removing the scanner from the stand and using it as a conventional hand-held scanner. The low level beam will not interfere with hand-held use of the scanner.

When replaced in the stand the scanner reverts automatically to the Autosense mode.

**Note:** Autosense mode can also be set up using a PHOTOSWITCH® reflector. See Accessories.

## **Setup Parameters**

The built-in setup parameters of the scanner fall into four general categories:

- Keyboard Wedge
- General Setup
- Message Format
- Symbologies

Each category controls parameters that relate to specific functions of scanner operations and its operation in wedge mode.

### **Keyboard Wedge Parameters**

Parameters that configure the scanner to operate in keyboard wedge mode include:

- Enable Wedge Mode
- Select Terminal Type

Chapter 4 shows how to enable the scanner to operate in wedge mode with a specific terminal type.

### **General Setup Parameters**

General setup parameters are basic to the operation of the scanner. These parameters control:

- System Status Display
- Power Consumption
- Beeper Operation
- Capture Count
- Spotter Beam
- Autosense Mode

General parameters are set by scanning bar code labels in Chapter 5.

### **Message Format Parameters**

Parameters that control the format and speed of messages transmitted to the host include:

- Prefix
- Suffix
- Scanner Identifier
- Code Identifier
- Preamble
- Postamble
- Intercharacter Delay

Message format parameters are enabled or disabled by scanning bar codes in Chapter 6.

### **Symbology Parameters**

The scanner can be configured to read the following bar code symbologies:

- Code 39
- UPC
- EAN/JAN
- Interleaved 2 of 5
- Standard 2 of 5
- Code 128
- Codabar

Symbologies are selected based on the requirements of the application.

You enable or disable symbologies by scanning bar codes in Chapter 7.

## Ordering a Scanner

The following figure shows the catalog number breakdown for ordering a scanner.

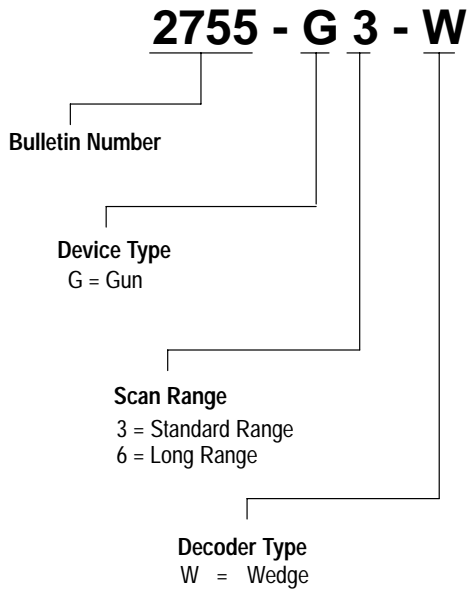

## Scanner Accessories

Table 2.A lists the wedge interface cables available for the supported terminal types. Included with each catalog number is an 8 foot (2.4 meter) coiled scanner interface cable.

**Table 2.A**  
**Wedge Interface Cables**

| <b>Catalog No.</b> | <b>Terminal Description</b>   |
|--------------------|---|
| 2755-NC20          | IBM-PC, -XT, -AT<br>Allen-Bradley 6120, 6121<br>Allen-Bradley 1784-T35, -T50, -T60<br>Allen-Bradley 2706-DL40 (AT or XT Mode)<br>Compaq DeskPro, Compaq 286 |
| 2755-NC21          | IBM PS/2 (50, 55, 60, 80)<br>Compaq 386   |
| 2755-NC22          | IBM 3151, 3472  |
| 2755-NC24          | DEC VT220, VT240, VT320, VT340, <b>1</b><br>VT420, VT1000   |

**1** Requires Catalog No. 2755-PW1 Power Supply

Table 2.B lists other accessories for the scanners.

**Table 2.B**  
**Scanner Accessories**

| <b>Catalog No.</b> | <b>Description</b>                                |
|--------------------|---|
| 2755-NS1           | Scanner Holder (included with scanner).           |
| 2755-NS2           | Autostand <b>2</b>                                |
| 2755-GB1           | Holster Belt                                      |
| 2755-GH5           | Scanner Holster (functions on belt or sling)      |
| 2755-PW1           | 5V Power Supply, 110 VAC, 60 Hz                   |
| 2755-NT1           | Reflective Tape, 2 inch (50.8 mm) square          |
| 92-39 <b>3</b>     | Circular Reflector, 3 inch (76.2 mm) diameter     |
| 92-47 <b>3</b>     | Circular Reflector, 1 1/4 inch (31.8 mm) diameter |

**2** Reflective tape is supplied with Autostand. Additional reflective tape is available by ordering Catalog No. 2755-NT1.

**3** Allen-Bradley PHOTOSWITCH® part number.



## Using the Scanner

### Chapter Objectives

This chapter covers some basic topics on the operation and use of the scanner including:

- Physical Description
- LED Indicators
- Safety Labels
- Scanning Ranges
- Operating Scanner
- Beep
- Operating Tips
- Troubleshooting

### Physical Description

The scanners use a low power visible laser diode light source for non-contact scanning applications.

The trigger in the handle of the scanner turns on the light beam. The beam exits the window on the front of the scanner.

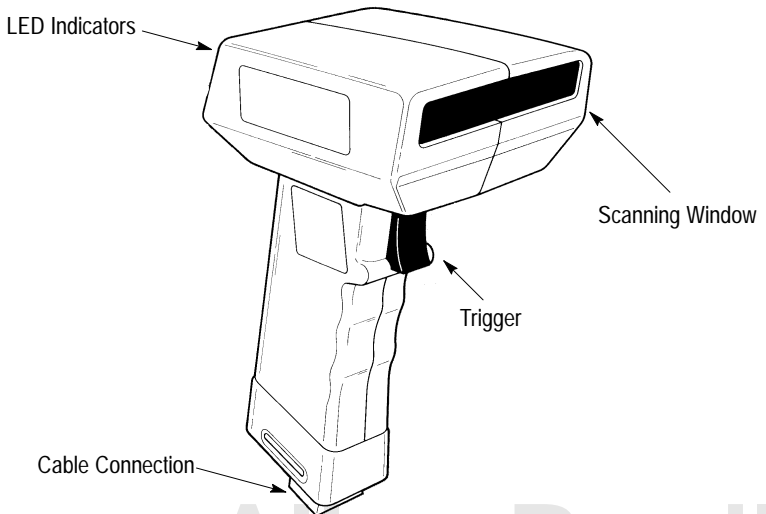

**Note:** If your scanner is enabled for Autosense mode, the internal object sensor is automatically triggered when bar codes are presented to it.

Light, reflected off the bar code symbols, passes back through the window and is detected by light sensors. When a label is read, the laser is automatically turned off until the next pull of the trigger.

The laser beam looks like a narrow red line of light. It is actually a tiny spot of light traveling very fast. The laser spot moves across the bar code symbol at approximately 35 scans/second. The bar code is scanned many times in a short period of time.

## LED Indicators

The rear of the scanner has two indicators that provide a visual indication of scanner operation.

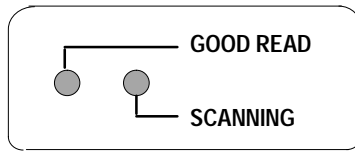

Table 3.A defines the color and function of each LED indicator.

**Table 3.A**  
LED Indicators

| LED Label | Color  | Function  |
|-----------|--------|---|
| GOOD READ | Green  | The GOOD READ light momentarily turns on (and you will hear a beep) when a bar code symbol has been successfully decoded. |
| SCANNING  | Yellow | The SCANNING light turns on when the device is scanning.  |

## Safety Labels

The scanners use a low power visible laser diode. As with any bright light source, such as the sun, you should avoid staring directly into the beam. Momentary exposure to a CDRH Class II laser is not known to be harmful.

The following figure shows the location of all safety labels as they appear on the scanner.

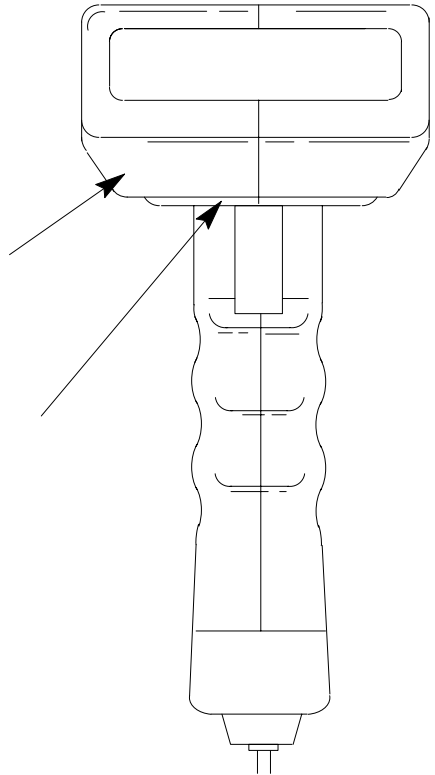

**CAUTION:**

Use of controls, adjustments, or performance of procedures other than those specified herein may result in hazardous visible light exposure.

## Scanning Ranges

The scanners can read bar code labels at various distances depending on the bar code width (width of narrowest element in bar code, either bar or space).

Table 3.B defines the scanning ranges for both the standard and long range scanner. Scanning ranges are listed for symbols with bar code widths from 6.0 mil to 55.0 mil (.15 mm to 1.40 mm).

**Table 3.B**  
**Scanning Ranges: Standard and Long Range Scanners**

| Bar Code Width     | Standard Range (2755-G3-W)             | Long Range (2755-G6-W)              |
|--------------------|--|-------------------------------------|
| 6.0 mil (.15 mm)   | 3.0 in - 5.0 in<br>7.6 cm - 12.7 cm    | N.A.                                |
| 7.5 mil (.19 mm)   | 2.5 in - 7.5 in<br>6.4 cm - 19.0 cm    | N.A.                                |
| 10.0 mil (.25 mm)  | 1.0 in - 10.0 in<br>2.5 cm - 25.4 cm   | N.A.                                |
| 15.0 mil (.38 mm)  | 1.5 in - 14.0 in<br>3.8 cm - 35.6 cm   | 8.0 in - 22 in<br>20.3 cm - 55.9 cm |
| 20.0 mil (.51 mm)  | 2.5 in - 18.0 in<br>6.4 cm - 45.7 cm   | 12 in - 36 in<br>30.5 cm - 91.4 cm  |
| 40.0 mil (1.02 mm) | 9.0 in - 25.0 in<br>22.9 cm - 63.5 cm  | 23 in - 60 in<br>58.4 cm - 152.4 cm |
| 55.0 mil (1.40 mm) | 12.0 in - 30.0 in<br>30.5 cm - 76.2 cm | 23 in - 66 in<br>58.4 cm - 167.6 cm |

Figure 3.1 illustrates the scanning ranges in graphic form. The figure shows that the scanning range of the standard range scanner for a 40.0 mil (1.02 mm) bar code width is 9.0 - 25.0 inches (22.9 - 63.5 cm). The scanning range of the long range scanner for the 40.0 mil (1.02 mm) bar code width is 23 - 60 inches (58.4 - 152.4 cm).

Figure 3.1  
Scanning Ranges

Standard Range Scanner  
Catalog No. 2755-G3-W

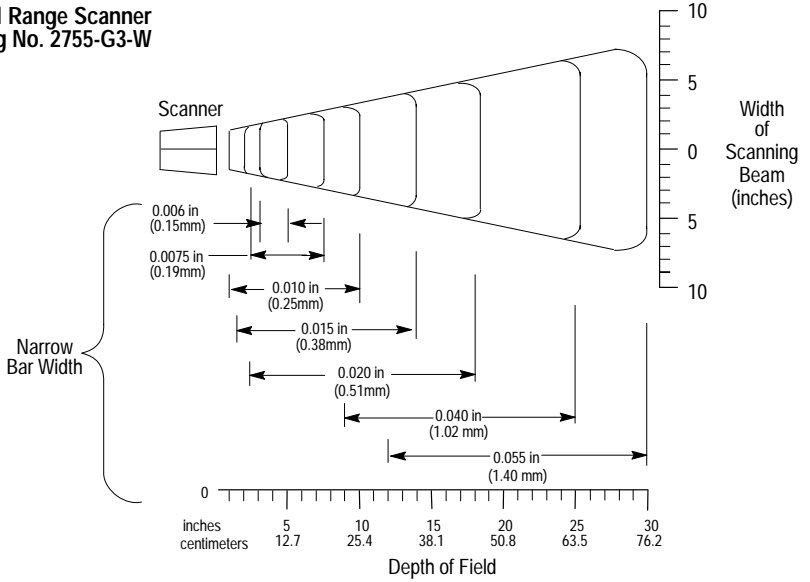

Long Range Scanner  
Catalog No. 2755-G6-W

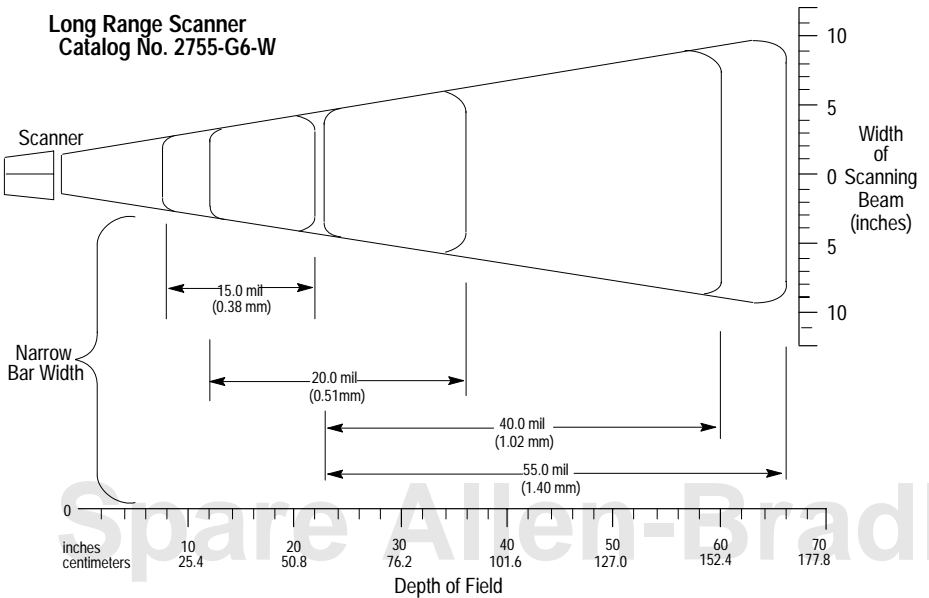

## Operating Scanner

Follow these basic steps to operate scanner.

### 1. Check

Before using the scanner, check all cable connections to make sure they are secure.

Chapter 4 defines the wedge interface connections for the scanner.

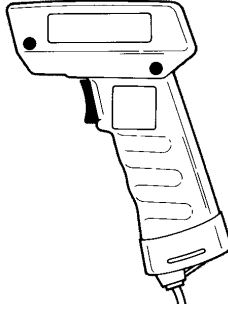

### 2. Test

Aim the scanner at the work surface and press the trigger. You should see the red beam on the work surface, and the SCANNING indicator on the back of the unit should be on.

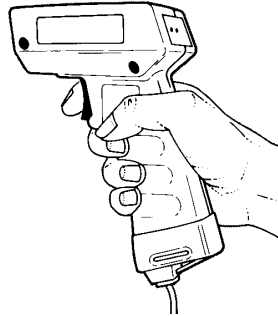

### 2. Scan

Aim the scanner at the bar code and press the trigger. Adjust the scanner position so the beam is centered on the bar code and overlaps it on both sides. When the scanner has read the symbol:

- You will hear a beep and/or ...
- The GOOD READ light will turn on momentarily.
- The red beam will turn off.

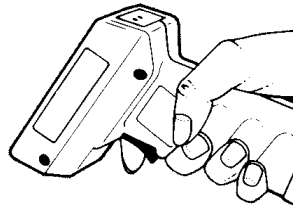
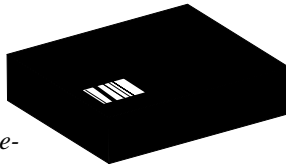

If you fail to scan, see the *Troubleshooting* section.

## Beep

When scanning a bar code symbol, listen for one short, high tone. It means the bar code has been decoded successfully.

## Operating Tips

### Hold at an Angle

Do not hold the scanner directly over the bar code. In this position light can bounce back into the scanner and prevent decoding. Angle the scanner slightly.

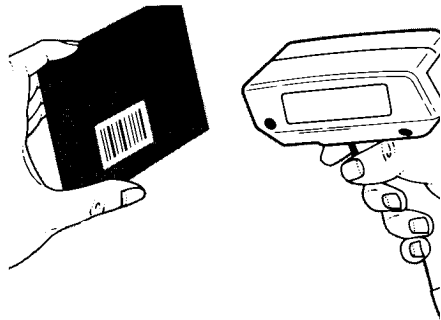

### Scan the Entire Symbol

- Move the scanner so the beam crosses every bar and space on the symbol.
- The larger the symbol the farther away you should hold the scanner.
- Hold the scanner closer for symbols with bars that are close together.
- If you have difficulty reading a label hold the scanner beyond the recommended range in Figure 3.B and then move the scanner closer.

RIGHT

WRONG

Spare Allen-Bradley

## Troubleshooting

This section provides a list of things to check if you are having problems scanning.

**Note: Scanning problems are most often caused by poor quality bar code symbols. If scanning problems arise test your bar code system using the high quality bar code test symbols supplied in Appendix A.**

- Make sure the scanner is configured to read the the type of bar codes you are trying to scan.
- Check if the bar code symbol is worn or damaged.
- Verify that you are holding the scanner at an angle.
- Make sure the beam crosses every bar and space on the symbol.
- Check for loose cable connections.
- Check that there is power to the scanner and the host computer or terminal.

If you perform these checks and the symbol still does not scan, contact your Allen-Bradley representative.



## Setup Instructions

### Chapter Objectives

This chapter provides setup instructions including:

- Installing the Wedge Interface
- Enabling Wedge Mode
- Selecting Terminal Type
- Scanner Configuration Guidelines
- Scanner Default Settings

### Installing Wedge Interface

Figure 4.1 shows the basic connections for installing the scanner as a keyboard wedge interface. The installation uses two cables: the scanner interface cable and the wedge interface cable. Cables for the different terminal types are listed in Table 2.A.

**Figure 4.1**  
Keyboard Wedge Interface Connections

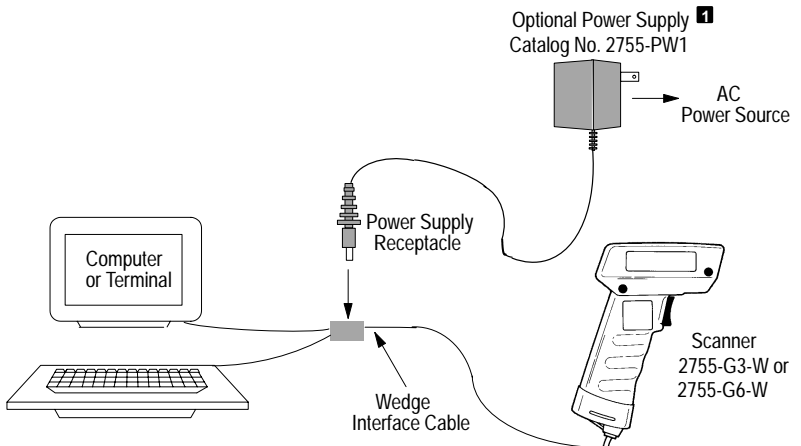

**1** Optional power supply required for DEC terminals.

### Connecting Scanner Interface Cable

The scanner interface cable has a modular plug (resembling a telephone connector) on one end and a DB9 squeeze-to-release connector on the other end.

To install the interface cable:

Insert the modular plug into the opening at the bottom of the scanner's handle (Figure 4.2). The modular plug is keyed to insure proper insertion. Press firmly until the plug clicks into place.

**Figure 4.2**  
Connecting Scanner Interface Cable

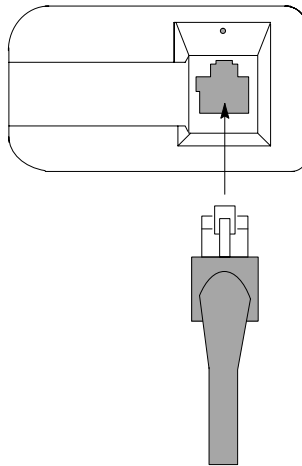

## Removing Scanner Interface Cable

At some point you may have to replace the interface cable with another cable.



**CAUTION:**

Do not remove the scanner interface cable until the host computer/terminal is turned off. Failure to do this could result in damage to the scanner.

---

To remove the interface cable, follow these steps.

1. Turn power to computer/terminal off.
2. Disconnect optional power supply from AC power source.
3. Disconnect scanner from wedge interface cable.
4. Insert a straightened paper clip into the cable release hole as shown in Figure 4.3.
5. Press down firmly on the paper clip to release the retainer and gently pull the connector out of the scanner.

**Figure 4.3**  
Removing Interface Cable

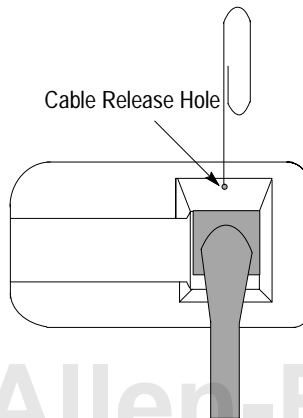

## Connecting Wedge Interface Cable

The wedge interface cable connects the scanner to the terminal keyboard and the terminal. You select a wedge interface cable based on the terminal you are using. The available cables are listed in Table 2.A.

The wedge interface cable has a connector housing and a "Y" cable. The housing contains 1 or 2 plug-in sockets for the scanner and an optional power supply. The two legs of the "Y" cable connect to the terminal keyboard and the terminal.



**CAUTION:**

Do not connect scanner to terminal until power to the terminal is off. Failure to do this could result in damage to the scanner.

---

To connect the wedge interface cable:

1. Turn off power to the computer/terminal to which the scanner will be connected.
2. Plug the DB9 squeeze-to-release connector of the scanner interface cable into the connector housing of the wedge interface cable.
3. Unplug the keyboard from the terminal and replug the keyboard into the short leg of the "Y" cable.
4. Plug the remaining long leg of the "Y" cable into the terminal where the keyboard was connected.
5. Arrange the fully connected unit so that all cables run freely.

## Connecting Optional Power Supply

Some terminal interfaces require an external power supply. One end connects to a standard AC receptacle supplying the appropriate voltage level. The other end plugs into a receptacle located on the housing connector of the wedge interface cable.



**CAUTION:**

The Catalog No. 2755-PW1 Power Supply has the following polarity:



If using another power supply, the polarity must be the same.

---

To install the power supply:

1. Power to the terminal must be turned off.



**CAUTION:**

Do not connect power supply until the terminal is turned off. Failure to follow this caution could result in damage to the scanner or terminal.

---

2. Plug the circular connector of the power supply into the receptacle on the housing connector of the wedge interface cable.
3. Plug the power supply into a standard AC power source.

## Terminal Power Up Sequence

Turn on the power to the terminal to which the scanner is connected. The unit will issue a series of beeps which are intentional and indicate that the terminal/keyboard power-on reset routines have been completed.

## Enabling Wedge Mode

After installing the keyboard wedge interface you need to enable the scanner to operate in wedge mode.

**If this is a first time installation you must enable the scanner to operate in wedge mode.**

To enable wedge mode, scan label **CE** and listen for two short beeps.

CE



Enable Wedge Mode \*

## Selecting a Terminal Type

You now need to identify the type of terminal that the wedge interface is connected to. Scan the appropriate label below and listen for two short beeps.

**First time installations require you to program the scanner for use with the connected terminal.**

CF



PC-AT \*

PS/2 and 50/60/80

Allen-Bradley 6121

Allen-Bradley 1784-T50, -T60

Allen-Bradley 2706-DL40 <sup>1</sup>

Allen-Bradley 1784-T35 (AT mode) <sup>2</sup>

Compaq 386, 286

CG



PC-XT

Allen-Bradley 6120, 2706-DL40 <sup>1</sup>

Allen-Bradley 1784-T35 (XT mode) <sup>2</sup>

Compaq Deskpro

<sup>1</sup> Can be used in AT or XT mode depending on the internal jumper. See DL40 User Manual.

<sup>2</sup> Can be used in AT or XT mode depending on the DIP switch setting. See User Manual for 1784-T35.

CH



IBM 3151,  
3472

CI



DEC VT220  
VT240, VT320, VT340,  
VT420, VT1000

You have now completed the process of installing and configuring the scanner to operate in wedge mode.

**The rest of the manual covers additional parameters that can be set for the scanner and your application. Review the configuration guidelines and factory default settings in the following sections to determine if changes are required.**

## Scanner Configuration Guidelines

Configuration is the process of enabling or disabling certain scanner operating parameters. The host computer/terminal and the types of bar codes that will be encountered will determine which parameters should be enabled or disabled.

Follow three basic steps to configure your scanner:

1. Review the rest of the manual to familiarize yourself with each group of scanner parameters.
2. Review the requirements of your application. This will enable you to determine if the factory defaults must be changed.
3. Enable or disable the relevant parameters by scanning the bar codes in Chapters 4 through 7. The section that follows describes this process. All configuration bar code labels in this manual are Code 128, Character Set B.

### Scanning Menu Labels

The scanner does not have a distinct configuration mode. Instead, it automatically recognizes and reacts to labels you scan. *You do not scan an enter or exit label to begin or exit configuration mode.*

Most parameters are set by scanning one label. For example, assume your application uses Codabar labels. By default, this symbology is disabled.

To select the Codabar symbology, locate the Codabar menu in Chapter 7 and scan the label to the left of **Enable Codabar**. The correct label is shown below.

VB



Enable  
Codabar

**A successful scan is indicated by two short-high beeps. An unsuccessful scan produces no beeps and requires you to rescan the Codabar label.**

Most parameters are modified in this way. When you are finished with modifications you can resume normal bar code scanning.



**Note:** When enabling or disabling a parameter, be sure the scanner beam illuminates only one symbol at a time. The layout of this manual minimizes the accidental scanning of multiple labels.

Some parameters require that you scan multiple labels to modify a setting. An example is the **Intercharacter Delay** parameter. To set the intercharacter delay to 5 milliseconds (msec):

1. Scan the **Intercharacter Delay (GB)** label and listen for *one* short beep.

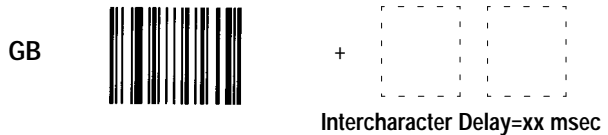

The dotted boxes to the right of the label indicate that you must scan two additional labels; one for the digit 0 and the second for the digit 5.

2. After the beep, scan the bar code beside 0 in Appendix B, and listen for one short-high beep.
3. Scan the bar code beside 5 in Appendix B and listen for *two* short beeps. The two beeps indicate that you scanned the last parameter argument.

If you scan the **Intercharacter Delay (GB)** label and then scan a normal data label (instead of 0 and 5), a normal tone is emitted in response to the data label, and the programming command is ignored. *No exit code is required to resume normal operations.*

**Note:** Any parameter that requires multiple scans will display dotted boxes to the right of the primary label. The number of dotted boxes indicates the number of additional labels to be scanned.

## Scanner Default Settings

Table 4.A lists the factory default settings for each group of scanner parameters.

**Table 4.A**  
**Scanner Default Settings**

### Keyboard Wedge

| Parameter     | Options   | Default               |
|---------------|---|-----------------------|
| Wedge Mode    | Enable or Disable                                       | Enable                |
| Terminal Type | PC-AT, PS/2, 50/60/80<br>PC-XT<br>IBM 3151<br>DEC VT220 | PC-AT, PS/2, 50/60/80 |

### General Scanner Setup

| Parameter         | Options   | Default                |
|-------------------|---|------------------------|
| Power Consumption | Enable Continuous Full Power<br>Enable Standby  | Continuous Full Power  |
| Beeper Operation  | Beeper Off<br>Beeper On; Volume Low<br>Beeper On; Volume Medium<br>Beeper On; Volume Loud | Beeper On; Volume Loud |
| Capture Count     | 1 or 2  | 1                      |
| Spotter Beam      | Enable or Disable   | Disable                |
| Autosense Mode    | Enable or Disable   | Disable                |

**Table 4.A (continued)**  
**Scanner Default Settings**

**Message Format**

| <b>Parameter</b>     | <b>Options</b>  | <b>Default</b>          |
|----------------------|---|-------------------------|
| Prefix               | None, STX, or SOH                                       | None                    |
| Suffix               | None, ETX, CR, LF, HT, or CR and LF                     | None                    |
| Scanner Identifier   | Disable or a number (01- 99)                            | Disable                 |
| Code Identifier      | Disable or Enable                                       | Disable                 |
| Preamble             | None or 1-4 characters                                  | None                    |
| Postamble            | None or 1-4 characters                                  | None                    |
| Intercharacter Delay | User Defined Delay (in msec) or No Intercharacter Delay | No Intercharacter Delay |

**Symbologies**

| <b>Code</b>   | <b>Options</b>   | <b>Default</b>                             |
|---------------|--|--|
| Code 39       | Disable<br>Enable Standard Code 39<br>Enable Full ASCII Code 39                            | Enable Standard Code 39                    |
|               | Enable or Disable Modulo 43<br>Check Character   | Disable                                    |
|               | Enable or Disable Transmission<br>of Start/Stop Character                                  | Disable                                    |
|               | Minimum Length   | 1  |
|               | Maximum Length   | 32   |
| UPC (A and E) | Disable<br>Enable with 2 or 5 digit supplements<br>Enable without 2 or 5 Digit Supplements | Enable without 2 or 5<br>Digit Supplements |
|               | Enable/Disable Expanded UPC-E  | Disable                                    |
|               | Enable/Disable Transmission<br>of Number System Character                                  | Enable                                     |
|               | Enable/Disable Transmission<br>of Check Digit  | Enable                                     |
|               | Enable/Disable UPC to EAN Translation  | Disable                                    |

**Table 4.A (continued)**  
**Scanner Default Settings**

**Symbologies**

| <b>Code</b>             | <b>Options</b>   | <b>Default</b> |
|-------------------------|--|----------------|
| EAN/JAN (8 or 13 digit) | Disable<br>Enable with 2 or 5 Digit Supplements<br>Enable without 2 or 5 Digit Supplements | Disable        |
|                         | Enable or Disable Transmission<br>Number System Character                                  | Enable         |
|                         | Enable or Disable Transmission<br>of Check Digit   | Enable         |
| Interleaved 2 of 5      | Disable<br>Enable without Check Digit<br>Enable with Check Digit                           | Disable        |
|                         | Minimum Length   | 2              |
|                         | Maximum Length   | 32             |
| Standard 2 of 5         | Enable or Disable  | Disable        |
|                         | Minimum Length   | 4              |
|                         | Maximum Length   | 32             |
| Code 128                | Enable or Disable  | Enable         |
|                         | Minimum Length   | 1              |
|                         | Maximum Length   | 32             |
| Codabar                 | Enable or Disable  | Disable        |
|                         | Enable or Disable Transmission<br>Number System Character                                  | Disable        |
|                         | Minimum Length   | 1              |
|                         | Maximum Length   | 32             |

**Resetting  
Factory Defaults**

To reset the scanner to the factory default settings (listed in Table 4.A) scan label **ZA**.

**ZA**

**Reset to  
Factory Defaults**

**Note:** Scanning this label produces a bi-level tone.

## General Setup Parameters

### Chapter Objectives

This chapter describes parameters specific to the operation of the scanner including:

- System Status
- Power Consumption
- Beeper Operation
- Capture Count
- Spotter Beam
- Autosense Mode

To set specific operating parameters, scan the appropriate bar code labels in each section.

**Note:** Throughout this chapter, default settings for parameters are flagged by an asterisk (\*).

### System Status

The labels in this section allow you to examine the configuration of your system.

To send a list of currently programmed parameters to the display device, scan option **ZB**. A sample display is shown on the top of the next page.

**Note:** Scanning **ZB** may interfere with your terminal software, depending on your application.

ZB



Display Configuration

**Display Configuration Example (ZB Command)**

|              |           |           |             |                  |          |
|--------------|-----------|-----------|-------------|------------------|----------|
| Power        | Always On | Model     | 5317        | Version          | 2.51     |
| Data Bits    | 7         | Beeper    | Loud        | Baud Rate        | 9600     |
| Char Delay   | 00        | Parity    | None        | Stop Bits        | 1        |
| Scanner ID   | None      | Protocol  | Off         | RTS              | Rcv Rdy+ |
| Preamble     | None      | Prefix    | Off         | Suffix           | Off      |
| Code ID Char | No        | Postamble | None        | * Redundant Scan | No       |
| Serial Buffr | Full      | Labels    | Full        | Label Delay      | 00       |
|              |           | Display   | Duplex Half | Auto Label Bfr   | Off      |

**Symbology**

| Parameter   | 39    | UPC | EAN | I 2/5 | S 2/5 | 128   | Codabr |
|-------------|-------|-----|-----|-------|-------|-------|--------|
| *Armed      | Yes   | Yes | No  | No    | No    | Yes   | No     |
| ASCII       | No    | -   | -   | -     | -     | -     | -      |
| *Addendum   | -     | No  | No  | -     | -     | -     | -      |
| Xmit S/S    | No    | -   | -   | -     | -     | -     | No     |
| Check Ch    | No    | -   | -   | No    | -     | -     | -      |
| Send Sys #  | -     | Yes | Yes | -     | -     | -     | -      |
| Send Ck Ch  | -     | Yes | Yes | -     | -     | -     | -      |
| UPCE Expand | -     | No  | -   | -     | -     | -     | -      |
| Limits      | 01-32 | -   | -   | 02-32 | 04-32 | 01-32 | 01-32  |

\* Redundant Scan=Capture Count, Armed=Enabled, Addendum=Supplements

Shaded parameters are not supported in this product.

Scan option **ZC** to send the program version number followed by carriage return-line feed (CR-LF) to the display device. The version number is sent in the form **##.##** (1.00, for example).

**ZC**



Transmit Version Number

Scan option **@C** to send an identification code which verifies the specific program type of the scanner to the display device.

**@C**



Transmit Program ID

**Note:** Options **ZC** and **@C** are used for troubleshooting to identify the scanner.

## Power Consumption

You can select one of two power consumption modes for the scanner. Option **@A** supplies full power to the scanner at all times. Option **@B** allows the scanner to revert to standby mode after a successful read. This mode is a power conservation feature whereby the scanner uses extremely low power (microwatts) from the host terminal.

To supply full power to the scanner at all times, scan label **@A**.

**@A**



Enable Continuous Full Power \*

**Note:** The scanner automatically uses full power when configured to operate in Autosense mode.

To allow the scanner to revert to standby mode after a successful read, scan label **@B**.

**@B**



Enable Standby Power

## Beeper Operation

To disable or set the volume of the beeper, scan the appropriate option below.

AA



Beeper Off

AB



Beeper On;  
Volume Low

AC

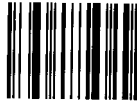

Beeper On;  
Volume Medium

AD



Beeper On;  
Volume Loud \*



## Capture Count

Capture Count determines the number of successful, identical decodes that must occur for a valid read. You can use the capture count to enhance the security of the bar code reader.

Option **BC** sets the capture count to 1 which requires one successful decode.

**BC**



Capture Count = 1 \*

Scan option **BD** to set the capture count to 2. Two identical decodes must occur for a valid read.

**BD**



Capture Count = 2

Because the laser scans a label many times a second, you will notice little or no change in the speed of the decode.

## Spotter Beam

You can enable the scanner to use a spotter beam which helps when aiming the scanner. Each time you press the trigger, the scanner generates a bright laser spot for a fixed duration, after which the scanner beam is activated.

The spotter beam is recommended for long range applications.

Scanning label **NP** disables the spotter beam. **Hold the trigger for two seconds after scanning.**



To enable the spotter beam, scan label **NQ**, then scan a digit from 0 – 9 (Appendix B), **holding the trigger for two seconds after scanning the digit.** Each digit enables the spotter beam for a specified duration as shown in the table below. For example, to enable the spotter beam for 200 milliseconds, scan the **NQ** label, then scan code 3 in Appendix B.



| This Digit | Enables Spotter Beam for: |
|------------|---------------------------|
| 0          | 50 ms                     |
| 1          | 100 ms                    |
| 2          | 150 ms                    |
| 3          | 200 ms                    |
| 4          | 250 ms                    |
| 5          | 300 ms                    |
| 6          | 350 ms                    |
| 7          | 400 ms                    |
| 8          | 450 ms                    |
| 9          | 500 ms                    |

**Note:** Spotter Beam and Autosense Mode are mutually exclusive parameters. Only one of these parameters can be enabled at a time.

## Autosense Mode

In Autosense mode, the scanner has an internal object sensor allowing you to operate the scanner in an optional Autostand (Catalog No. 2755-NS2) for hands-free operation.

When the scanner is placed in the Autostand it becomes immediately active for reading any bar code label presented to it. The scanner is triggered when a bar code label breaks the scan beam path between the reflective label on the stand and the scanner.

To activate Autosense mode, scan the **Enable Autostand (NO)** label. **You must hold the trigger down for two seconds after scanning the label.**

NO

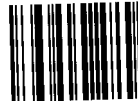

Enable  
Autosense Mode

The scanner will respond by emitting a continuous, low level, red beam of light.

**Note:** The scanner is automatically configured to use full power (not standby power) in Autosense mode.

For details on how to set up the scanner to operate in the optional Autostand, see Appendix C.

To deactivate Autosense mode, scan the **Disable Autostand** symbol (NN). **You must hold the trigger down for two seconds after scanning the label.**

NN



Disable  
Autosense Mode \*

**Note:** Spotter Beam and Autosense Mode are mutually exclusive parameters. Only one of these parameters can be enabled at a time.

## Message Format Parameters

### Chapter Objectives

This chapter defines parameters that control the format of transmitted bar code messages including:

- Prefix and Suffix
- Scanner Identifier
- Code Identifier
- Preamble and Postamble

In addition to these parameters, you can program an intercharacter delay to prevent data overruns with your host computer/terminal or wedge.

### Message Format

A message transmitted from the scanner upon a successful decode has the following format:

|        |                    |          |                 |      |           |        |
|--------|--------------------|----------|-----------------|------|-----------|--------|
| Prefix | Scanner Identifier | Preamble | Code Identifier | Data | Postamble | Suffix |
|--------|--------------------|----------|-----------------|------|-----------|--------|

Some of these message parameters may not be required or may vary from one host system to another. You select parameters based on the requirements of your application and the host system.

To select message parameters, you scan the appropriate bar code labels in each section.

**Note:** Throughout this chapter default settings for parameters are flagged by an asterisk (\*).

## Prefix

A prefix is a subset of the preamble normally formatted to some industry standard. It is represented by a specific ASCII code. An example of a prefix is the STX (Start of Transmission) code.

Scan the appropriate prefix label.

IA



Prefix=None \*

IB



Prefix=STX

IC



Prefix=SOH

Pref

Spare Allen-Bradley

## Suffix

A suffix is a subset of the postamble. Like the prefix, it is normally assigned to a specific ASCII code. Examples of suffixes are CR (Carriage Return) and LF (Line Feed).

Scan the suffix appropriate for your application.

MA  Suffix=None \*

MB  Suffix=ETX

MC  Suffix=CR

MD  Suffix=LF

ME  Suffix=HT

MF  Suffix=CR and LF

## Scanner Identifier

Scanner ID characters are used to identify individual scanners when more than one scanner is interfaced with the host system. Options available are none (Disabled) or digits 01 through 99.

Scanning label **JA** disables the scanner identifier.

**JA**



Disable  
Scanner Identifier \*

To enter a scanner ID, scan label **JB** and then two separate digits from Appendix B. The ID characters cannot exceed 99.

**JB**



Enable Scanner Identifier  
plus two characters

For example, to enter a scanner ID of 01, scan the **JB** label, then scan codes 0 and 1 in Appendix B.

## Code Identifier

A single-character code identifier may optionally be transmitted with a message. This option allows the host computer to identify the type of bar code scanned, as well as the encoded information.

Scan option **FA** to disable the code identifier.

**FA**  **Disable Code Identifier \***

Scan option **FB** to enable the code identifier.

**FB**  **Enable Code Identifier**

Table 6.A shows the code identifier character assignments.

**Table 6.A**  
Code Identifier Characters

| <b>Symbology</b>   | <b>Code Identifier</b> |
|--------------------|------------------------|
| Code 39            | a                      |
| Interleaved 2 of 5 | b                      |
| Standard 2 of 5    | c                      |
| UPC/EAN/JAN        | d                      |
| Code 128           | f                      |
| Codabar            | h                      |



## Preamble or Postamble

Preambles and postambles consist of up to four ASCII characters. Each ASCII character is encoded as two hexadecimal characters. Use Table 6.B, Hexadecimal Conversion Table, to look up the hexadecimal equivalent.

To use the conversion table:

1. Find each ASCII character in the table and locate the corresponding **bold** hexadecimal equivalent character in the top row and the left column of the table. For example, the ASCII character "Q" is represented by the hexadecimal numbers **5** (top) and **1** (left).
2. Scan the bar code symbols that correspond to the hexadecimal equivalent characters. First scan the bar code symbol that corresponds to the bold hex character at the *top*. Then scan the bar code symbol that corresponds to the bold hex character at the *left*.

For example, for the ASCII character "Q", first scan the bar code symbol labeled **5**, then scan the bar code symbol labeled **1**. If your preamble or postamble contains an "N", first scan **4** and then **E**.

3. Repeat this procedure for each ASCII character you want to enter.

**Note:** If you select a preamble or postamble you must scan four ASCII characters, even if the preamble or postamble is less than four characters in length. Do this by scanning null (NUL) characters for the additional characters.

For example, if your preamble is "AB" (in ASCII code), enter A, B, and two null characters by scanning the hexadecimal characters **4,1 4,2 0,0 0,0**. Because each ASCII character is represented by two hexadecimal characters, you need eight scans.

# Spare Allen-Bradley

## Preamble

A preamble is a string of characters that prefixes a message that is transmitted to the host. The preamble may be used to identify the scanner that sent the message. The maximum preamble length is four ASCII characters.



To enter a preamble, scan the **KB** label, then refer to Table 6.B to enter the four ASCII characters. The procedure on the previous page explains how to enter preamble characters.

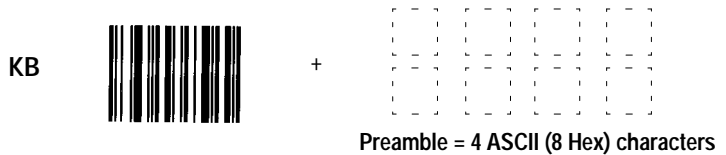

## Postamble

A postamble is similar to a preamble, except it is appended to the message which is transmitted to the host. Its maximum length is four ASCII characters.



To enter a postamble, scan the **LB** label, then refer to Table 6.B to enter the four ASCII characters. The procedure on the previous page explains how to enter preamble characters.

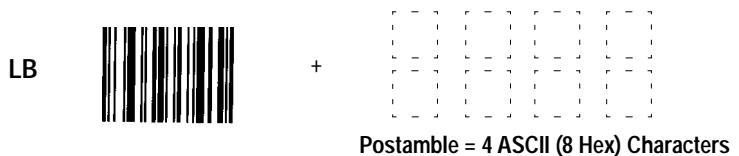



**Table 6.B**  
Hexadecimal Conversion Table

|   | 0   | 1   | 2  | 3 |
|---|-----|-----|----|---|
| 0 | NUL | DLE | SP | 0 |
| 1 | SOH | DC1 | !  | 1 |
| 2 | STX | DC2 | "  | 2 |
| 3 | ETX | DC3 | #  | 3 |
| 4 | EOT | DC4 | \$ | 4 |
| 5 | ENQ | NAK | %  | 5 |
| 6 | ACK | SYN | &  | 6 |
| 7 | BEL | ETB | '  | 7 |
| 8 | BS  | CAN | (  | 8 |
| 9 | HT  | EM  | )  | 9 |
| A | LF  | SUB | *  | : |
| B | VT  | ESC | +  | ; |
| C | FF  | FS  | ,  | < |
| D | CR  | GS  | -  | = |
| E | SO  | RS  | .  | > |
| F | SI  | US  | /  | ? |

**Table 6.B (continued)**  
**Hexadecimal Conversion Table**

|          | <b>4</b> | <b>5</b> | <b>6</b> | <b>7</b> |
|----------|----------|----------|----------|----------|
| <b>0</b> | @        | P        | '        | p        |
| <b>1</b> | A        | Q        | a        | q        |
| <b>2</b> | B        | R        | b        | r        |
| <b>3</b> | C        | S        | c        | s        |
| <b>4</b> | D        | T        | d        | t        |
| <b>5</b> | E        | U        | e        | u        |
| <b>6</b> | F        | V        | f        | v        |
| <b>7</b> | G        | W        | g        | w        |
| <b>8</b> | H        | X        | h        | x        |
| <b>9</b> | I        | Y        | i        | y        |
| <b>A</b> | J        | Z        | j        | z        |
| <b>B</b> | K        | [        | k        | {        |
| <b>C</b> | L        | \        | l        |          |
| <b>D</b> | M        | ]        | m        | }        |
| <b>E</b> | N        | ^        | n        | ~        |
| <b>F</b> | O        | _        | o        | DEL      |



**8**



**9**



**A**



**B**



**C**



**D**



**E**



**F**

## Intercharacter Delay

Certain terminals and computers require an intercharacter delay to simulate the effects of keystroke delays. Selecting an intercharacter delay causes the characters to be sent at the slower rate required by the device to which you are interfacing.

Scanning label **GA** disables intercharacter delay.



To set Intercharacter Delay to a value other than zero, scan label **GB**, then two separate digits from Appendix B. **The intercharacter delay cannot exceed 31 milliseconds.**



For example, to set the delay to 15 milliseconds, scan the **GB** label, then scan codes 1 and 5 in Appendix B.

## Symbologies

### Chapter Objectives

This chapter shows how to enable bar code symbologies the scanner is capable of reading including:

- Code 39
- UPC-A and UPC-E  
(with optional 2 or 5-digit supplements)
- EAN-8 and EAN-13  
(with optional 2 or 5-digit supplements)
- Interleaved 2 of 5
- Standard 2 of 5
- Code 128
- Codabar

To disable or enable specific bar code symbologies, scan the appropriate bar code labels in each section.

**Note:** We recommend that you disable all symbologies not used by your application.

Throughout this chapter, the default symbology selections are flagged by an asterisk (\*).

### Label Lengths

The minimum label lengths are set to 1 character, except for Interleaved 2 of 5 which is set to 2 characters and Standard 2 of 5 which is set to 4 characters. The maximum label length for all symbologies is set to 32 characters. You can set minimum and maximum label lengths.

**Note:** The minimum length must be less than or equal to the maximum length for scanning to occur.

## Code 39

To disable Code 39, scan label **OA**.

**OA**



Disable Code 39

To enable Code 39, scan option **OB** or **OC**. After enabling Code 39, make any additional required selections from options **OD** through **OI**.

**OB**



Enable Standard Code 39 \*

**OC**



Enable Full ASCII Code 39

### Modulo 43 Check Character

Options **OD** and **OE** allow you to enable or disable the Modulo 43 check character for Code 39. To enable the Modulo 43 check character, scan label **OE**. To disable the Modulo 43 check character, scan label **OD**.

**OD**

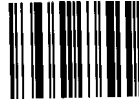

Disable Modulo 43 \*  
Check Character

**OE**



Enable Modulo 43  
Check Character

### Transmit Start/Stop Characters

You can transmit or suppress the Start and Stop characters in Code 39. To suppress transmission of the Start and Stop characters, scan label **OF**.

**OF**



Do Not Transmit \*  
Start and Stop

To enable transmission of the Start and Stop characters, scan label **OG**.

**OG**



Transmit  
Start and Stop



**Code 39  
(continued)**

**Minimum Length**

The minimum length of Code 39 is set by scanning label **OH** and then two digits (01 - 32) in Appendix B.

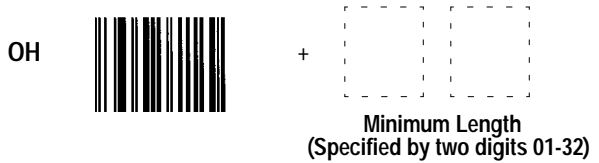

For example, to enter a minimum length of 05, scan the **OH** label, then scan codes 0 and 5 in Appendix B.

**Maximum Length**

The maximum length of Code 39 is set by scanning label **OI** and then two digits (01 - 32) in Appendix B.

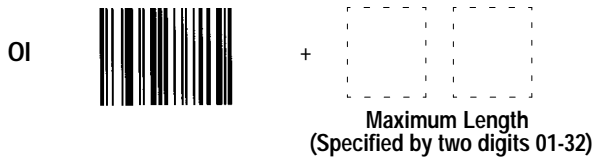

For example, to enter a maximum length of 05, scan the **OI** label, then scan codes 0 and 5 in Appendix B.

**If the minimum and maximum lengths are set equal, only codes of that exact length are read.**

## UPC (A and E)

To disable all UPC labels, scan label **QA**.

**QA**



Disable UPC (A and E)

### Supplements

Option **QB** or option **QC** enable both UPC-A and UPC-E. To enable scanning of UPC labels with the 2 or 5 Digit supplements, scan label **QB**.

**QB**



Enable UPC  
with 2 or 5 Digit  
Supplement Enabled

To enable scanning of UPC labels with the 2 or 5 Digit supplements disabled, scan label **QC**.

**QC**



Enable UPC \*  
with 2 or 5 Digit  
Supplement Disabled

### Expanded UPC-E

You can enable/disable expansion of E labels to A labels. To disable expanded UPC-E, scan label **QH**.

**QH**



Disable \*  
Expanded UPC-E

To enable expansion of E labels to A labels, scan label **QI**.

**QI**



Enable  
Expanded UPC-E

## UPC (A and E) (continued)

### Transmit Number System Digit

You can enable or disable the transmission of the first character in a UPC symbol (the number system character). To disable transmission of the first character in a UPC symbol, scan label **QD**.

**QD**



Disable Transmission  
Number System Digit

To enable transmission of the first character in a UPC symbol (the number system character), scan label **QE**.

**QE**

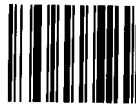

Enable Transmission \*  
Number System Digit

### Transmit Check Digit

You can enable or disable the transmission of the last character in a UPC symbol (the check digit). To disable transmission of the check digit in a UPC symbol, scan label **QF**.

**QF**



Disable Transmission  
of Check Digit

To enable transmission of the check digit in a UPC symbol, scan label **QG**.

**QG**



Enable Transmission  
of Check Digit \*

### UPC to EAN Translation

You can cause UPC labels to be transmitted as EAN-13 labels. To enable UPC to EAN translation, scan label **QJ**.

**QJ**

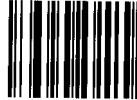

**Enable UPC to EAN  
Translation**

To disable UPC to EAN translation, scan label **QK**.

**QK**

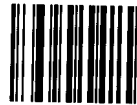

**Disable UPC to EAN  
Translation \***

## EAN/JAN

Scan label **RA** to disable EAN/JAN (8 or 13 digit).

**RA**



Disable EAN/JAN \*  
(8 or 13 digit)

### Supplements

Option **RB** or option **RC** enables both EAN 8-digit and EAN 13-digit. EAN/JAN labels can be read with or without supplements. To enable scanning of EAN/JAN labels with the 2 or 5 digit supplements, scan label **RB**.

**RB**



Enable EAN/JAN  
with 2 or 5 Digit  
Supplement Enabled

To enable scanning of EAN/JAN labels with the 2 or 5 Digit supplements disabled, scan label **RC**.

**RC**



Enable EAN/JAN  
with 2 or 5 Digit  
Supplement Disabled

### Transmit Number System Digit

You can enable or disable the transmission of the first character in an EAN/JAN symbol (the number system character). To disable transmission of the first character in an EAN/JAN symbol, scan label **RD**.

**RD**



Disable Transmission  
Number System Digit

To enable transmission of the first character in an EAN/JAN symbol, scan label **RE**.

**RE**



Enable Transmission \*  
Number System Digit

### Transmit Check Digit

You can enable or disable the transmission of the last character in an EAN/JAN symbol (the check digit). To disable transmission of the check digit in an EAN/JAN symbol, scan label **RF**.

**RF**



Disable Transmission  
of Check Digit

To enable transmission of the check digit in an EAN/JAN symbol, scan label **RG**.

**RG**



Enable Transmission  
of Check Digit \*

## Interleaved 2 of 5

Scan label **PA** to disable Interleaved 2 of 5.

**PA**



Disable  
Interleaved 2 of 5 \*

### Check Digit

You can enable Interleaved 2 of 5 with or without the check digit. To enable Interleaved 2 of 5 without the check digit, scan label **PB**.

**PB**



Enable  
Interleaved 2 of 5  
without Check Digit

To enable Interleaved 2 of 5 with the check digit, scan label **PC**.

**PC**



Enable  
Interleaved 2 of 5  
with Check Digit

### Minimum Length

To set a minimum length (other than two) for Interleaved 2 of 5, scan label **PD** and then two digits (02-32) in Appendix B. **The value of the number you scan must be even. Odd numbers are ignored.**



For example, to enter a minimum length of 12, scan the **PD** label, then scan codes 1 and 2 in Appendix B.

### Maximum Length

To set a maximum length for Interleaved 2 of 5, scan label **PE** and then two digits (02-32) in Appendix B. **The value of the number you scan must be even.**

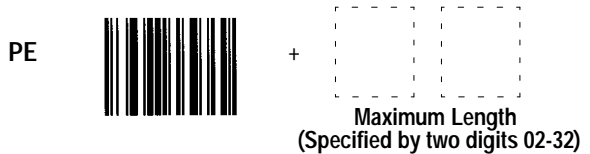

For example, to enter a maximum length of 12, scan the **PE** label, then scan codes 1 and 2 in Appendix B.

**If the minimum and maximum lengths are set equal, only codes of that exact length are read.**



## Standard 2 of 5

Scan label **PF** to disable Standard Code 2 of 5.



To enable Standard Code 2 of 5, scan label **PG**.



### Minimum Length

To set a minimum length (other than 4) for Standard Code 2 of 5, scan label **PH** and then two digits (04-32) in Appendix B.

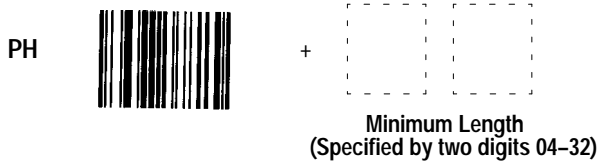

### Maximum Length

To set a maximum length for Standard Code 2 of 5 messages, scan label **PI** and then two digits (04-32) in Appendix B.

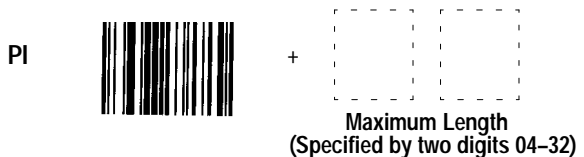

If the minimum and maximum lengths are set equal, only codes of that exact length are read.

## Code 128

Scan label **TA** to disable Code 128.



Scan option **TB** to enable Code 128.



### Minimum Length

To set a minimum length for Code 128, scan label **TC**, then two digits (01-32) in Appendix B.



### Maximum Length

To set a maximum length for Code 128, scan **TD**, then two digits (01-32) in Appendix B.



**If the minimum and maximum lengths are set equal, only codes of that exact length are read.**

## Codabar

Scan label **VA** to disable Codabar.

**VA**



Disable Codabar \*

Scan option **VB** to enable Codabar.

**VB**



Enable Codabar

### Transmit Start/Stop Characters

You can enable or disable the transmission of the Start and Stop characters in Codabar. To disable transmission of the Start and Stop characters, scan label **VC**.

**VC**



Disable Transmission \*  
Start/Stop Characters

To enable transmission of the Start and Stop characters, scan label **VD**.

**VD**

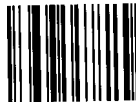

Enable Transmission  
Start/Stop Characters

### Minimum Length

To set a minimum length for Codabar messages, scan label **VE** and then two digits (01-32) in Appendix B.

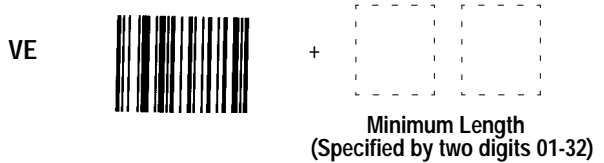

For example, to enter a minimum length of 05, scan the **VE** label, then scan codes 0 and 5 in Appendix B.

### Maximum Length

To set a maximum length for Codabar messages, scan label **VF**, and then two digits (01-32) in Appendix B.

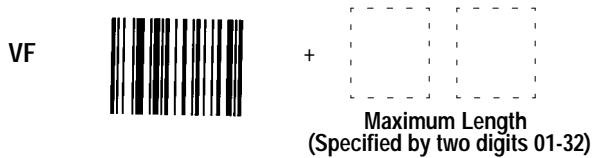

For example, to enter a minimum length of 05, scan the **VF** label, then scan codes 0 and 5 in Appendix B.

**If the minimum and maximum lengths are set equal, only codes of that exact length are read.**

## Specifications

**Hand Held Scanners**  
**Catalog No. 2755-G3-W**  
**Catalog No. 2755-G6-W**

### Optical

Nominal Scan Rate 35 scans/second  
Wavelength (nominal) 670 nm  
Maximum Pitch  $\pm 55$  degrees  
Maximum Skew  $\pm 65$  degrees  
Scanning Range

| Minimum Bar Width     | Standard Range (2755-G3-W)             | Long Range (2755-G6-W)              |
|-----------------------|--|-------------------------------------|
| 6.0 mil<br>(.15 mm)   | 3.0 in - 5.0 in<br>7.6 cm - 12.7 cm    | N.A.                                |
| 7.5 mil<br>(.19 mm)   | 2.5 in - 7.5 in<br>6.4 cm - 19.0 cm    | N.A.                                |
| 10.0 mil<br>(.25 mm)  | 1.0 in - 10.0 in<br>2.5 cm - 25.4 cm   | N.A.                                |
| 15.0 mil<br>(.38 mm)  | 1.5 in - 14.0 in<br>3.8 cm - 35.6 cm   | 8.0 in - 22 in<br>20.3 cm - 55.9 cm |
| 20.0 mil<br>(.51 mm)  | 2.5 in - 18.0 in<br>6.4 cm - 45.7 cm   | 12 in - 36 in<br>30.5 cm - 91.4 cm  |
| 40.0 mil<br>(1.02 mm) | 9.0 in - 25.0 in<br>22.9 cm - 63.5 cm  | 23 in - 60 in<br>58.4 cm - 152.4 cm |
| 55.0 mil<br>(1.40 mm) | 12.0 in - 30.0 in<br>30.5 cm - 76.2 cm | 23 in - 66 in<br>58.4 cm - 167.6 cm |

### Scanning Range

Autosense Mode 36 in (91.4 cm) maximum  
(to reflective label or tape)

### Electrical

Supply Voltage 4.75 to 14 VDC

### Current Consumption

While Scanning 200 mA maximum

Standby Power 100  $\mu$ A maximum

Continuous Full Power 200 mA maximum **1**

**1** Autosense mode automatically uses continuous full power.

### **Mechanical**

#### Dimensions

Inches 4.0(L) x 2.8(W) x 6.6(H)  
Millimeters 102(L) x 71(W) x 168(H)

Weight 8.0 oz (0.23 kg)

#### LED Indicators

Good Read Green  
Scanning Yellow

### **Environmental**

Operating Temperature 0° to 122° F  
-18° to +50° C

Storage Temperature -40° to 158° F  
-40° to +70° C

Relative Humidity 5 to 95% (noncondensing)

Electrostatic Discharge 15kv to any  
external surface

Drop Test 5 feet (1.27 meter)  
on concrete

Dust and Rain MIL STD 810D  
Sections 510.2I & 506.2II

### **Interface**

Keyboard Wedge

### **Certification**

Dept. of Health and Human Services (DHHS) Class II laser product.  
Complies with DHHS radiation performance standards, 21 CFR subchapter J.

## Bar Code Test Symbols

Use the following labels to insure that your scanner is functioning properly. The only label the long range scanner can read below is the Interleaved 2-of-5 (15 mil) label.



**UPC E 13 MIL**



**EAN 8 13 MIL**



**UPC A 13 MIL**



**EAN 13 13 MIL**



**Code 39 11 MIL**



**Code 128 11 MIL**

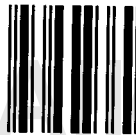

**1234  
Interleaved 2-of-5 15 MIL**

### Digit Selection Symbols

0



1



2



3



4



5



6



7



8



9





## Autosense Mode

To set up the scanner to operate in Autosense mode using the optional Autostand follow the steps below while referring to Figure C.1.

1. Enable the scanner to operate in Autosense mode by scanning the **Enable Autosense (NO)** label in Chapter 5.
2. Attach the *Stand Riser* to the *Stand Base* using two of the supplied #6-32 thumb screws.
3. Attach the *Scanner Holder* to the top of the *Stand Riser* using the other two #6-32 thumb screws.
4. Verify that the reflective label is affixed to the *Stand Base*.
5. Place the scanner in the stand as shown in Figure C.1.
6. Check that the red beam of light is aimed at the reflective label on the stand.

The Autostand is now ready to read bar code labels presented to it.

While the scanner is activated in Autosense mode you are able to remove the scanner from its holder and use it for hand-held applications. When the scanner is removed from the Autostand the scanning beam is turned on automatically to read a bar code label. If the scanner does not see a label the scanning beam will turn off after four seconds. Scanning is re-initiated by manually pulling the trigger. The scanner can then be placed into the stand once again and it will function in Autosense mode.

Figure C.1  
Autostand

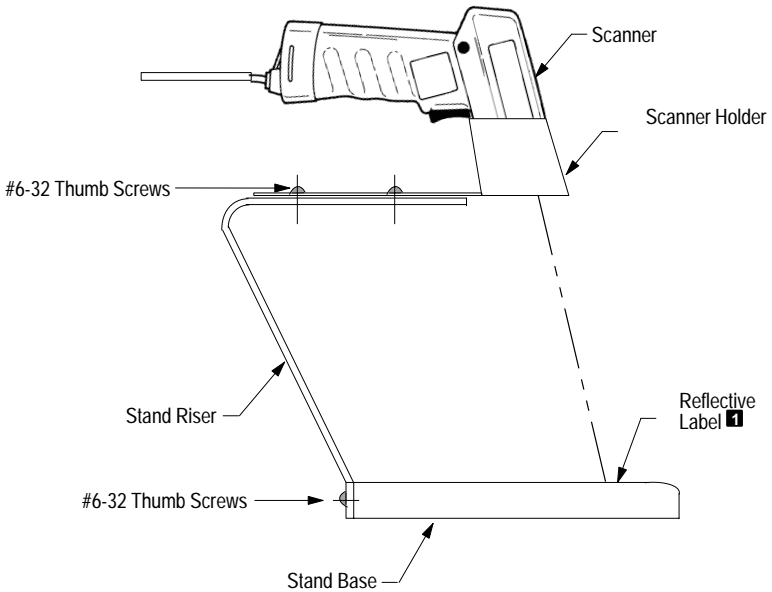

**Important:** When the scanner is to be powered from a battery such as in a hand-held terminal, you should disable Autosense mode. In this application, you may need to use the power conservation mode of the scanner when drawing power from a battery. Autosense mode will function only in full power mode.

**1** Reflective tape is supplied with the autostand. Additional reflective tape is available by ordering Catalog No. 2755-NT1.

## Maintenance

This appendix provides general maintenance information for your scanner.

### Cleaning Window

You may need to clean the window of the scanner. **Carefully** clean the window by first removing loose particles of dirt with clean air. Then use a soft, lint free cloth moistened with an *optical quality cleaning fluid* for **plastic lenses** and wipe the window in a single direction (don't wipe cloth back and forth across window). Do not leave streaks.

**CAUTION:**

Do not use abrasive material or solvents (e.g., alcohol or acetone) on the window. These items may damage the window or finish on the scanner.

---

**WARNING:**

The scanner has no serviceable parts. Do not open the housing of the scanner.

---

### Inspecting Cables

Periodically inspect the cable on the scanner for wear and other signs of damage. A worn or damaged cable may interfere with the operation of the scanner. Contact your Allen-Bradley representative to order replacement cables.

## Scanner Parameters

Each bar code label in this manual is preceded by two characters. The following tables list the two character mnemonic for each scanner parameter and the page location of the corresponding label.

### General Scanner Setup Parameters

| Mnemonic | Function                        | Page # |
|----------|---------------------------------|--------|
| ZA       | Set Scanner to Factory Defaults | 4-10   |
| ZB       | Display Scanner Configuration   | 5-1    |
| ZC       | Transmit Program Version Number | 5-2    |
| @C       | Transmit Program ID             | 5-2    |
| @A       | Enable Full Continuous Power    | 5-3    |
| @B       | Enable Standby Power            | 5-3    |
| AA       | Beeper Off                      | 5-4    |
| AB       | Beeper On; Volume Low           | 5-4    |
| AC       | Beeper On; Volume Medium        | 5-4    |
| AD       | Beeper On; Volume Loud          | 5-4    |
| BC       | Capture Count=1                 | 5-5    |
| BD       | Capture Count=2                 | 5-5    |
| NP       | Disable Spotter Beam            | 5-6    |
| NQ       | Enable Spotter Beam             | 5-6    |
| NO       | Enable Autosense Mode           | 5-7    |
| NN       | Disable Autosense Mode          | 5-7    |

**Wedge Parameters**

| <b>Mnemonic</b> | <b>Function</b>  | <b>Page #</b> |
|-----------------|--|---------------|
| CE              | Enable Wedge Mode  | 4-6           |
| CF              | Terminal Type = PC-AT, PS/2 and 50/60/80,<br>Allen-Bradley 6121,<br>Allen-Bradley 1784-T50, -T60<br>Allen-Bradley 2706-DL40<br>Allen-Bradley 1784-T35 (AT mode)<br>Compaq 386, 286 | 4-6           |
| CG              | Terminal Type = PC-XT,<br>Allen-Bradley 6120, 2706-DL40,<br>Allen-Bradley 1784-T35 (XT mode)<br>Compaq Deskpro   | 4-6           |
| CH              | Terminal Type = IBM 3151, 3472   | 4-7           |
| CI              | Terminal Type = DEC VT220, VT240, VT320,<br>VT340, VT420, VT1000   | 4-7           |

**Message Format Parameters**

| <b>Mnemonic</b> | <b>Function</b>                | <b>Page #</b> |
|-----------------|--------------------------------|---------------|
| IA              | Prefix = None                  | 6-2           |
| IB              | Prefix = STX                   | 6-2           |
| IC              | Prefix = SOH                   | 6-2           |
| MA              | Suffix=None                    | 6-3           |
| MB              | Suffix = ETX                   | 6-3           |
| MC              | Suffix = CR                    | 6-3           |
| MD              | Suffix = LF                    | 6-3           |
| ME              | Suffix = HT                    | 6-3           |
| MF              | Suffix = CR and LF             | 6-3           |
| JA              | Disable Scanner Identifier     | 6-4           |
| JB              | Enable Scanner Identifier      | 6-4           |
| FA              | Disable Code Identifier        | 6-5           |
| FB              | Enable Code Identifier         | 6-5           |
| KA              | Preamble = None                | 6-7           |
| KB              | Preamble = 4 ASCII Characters  | 6-7           |
| LA              | Postamble = None               | 6-7           |
| LB              | Postamble = 4 ASCII Characters | 6-7           |
| GA              | No Intercharacter Delay        | 6-10          |
| GB              | Set Intercharacter Delay       | 6-10          |

**Symbology Parameters**

| <b>Mnemonic</b> | <b>Function</b>                                       | <b>Page #</b> |
|-----------------|---|---------------|
| OA              | Disable Code 39                                       | 7-2           |
| OB              | Enable Standard Code 39                               | 7-2           |
| OC              | Enable Full ASCII Code 39                             | 7-2           |
| OD              | Disable Modulo 43 Check Character                     | 7-3           |
| OE              | Enable Modulo 43 Check Character                      | 7-3           |
| OF              | Do Not Transmit Code 39 Start/Stop Characters         | 7-3           |
| OG              | Transmit Code 39 Start/Stop Characters                | 7-3           |
| OH              | Set Minimum Length for Code 39 Labels                 | 7-4           |
| OI              | Set Maximum Length for Code 39 Labels                 | 7-4           |
| QA              | Disable UPC (A and E)                                 | 7-5           |
| QB              | Enable UPC (A and E) with 2 or 5 Digit Supplements    | 7-5           |
| QC              | Enable UPC (A and E) without 2 or 5 Digit Supplements | 7-5           |
| QD              | Disable Transmission UPC Number System Digit          | 7-6           |
| QE              | Enable Transmission UPC Number System Digit           | 7-6           |
| QF              | Disable Transmission UPC Check Digit                  | 7-6           |
| QG              | Enable Transmission UPC Check Digit                   | 7-6           |
| QH              | Disable Expanded UPC-E                                | 7-5           |
| QI              | Enable Expanded UPC-E                                 | 7-5           |
| QJ              | Enable UPC to EAN Translation                         | 7-7           |
| QK              | Disable UPC to EAN Translation                        | 7-7           |
| RA              | Disable EAN/JAN (8 or 13)                             | 7-8           |
| RB              | Enable EAN/JAN with 2 or 5 Digit Supplements          | 7-8           |
| RC              | Disable EAN/JAN without 2 or 5 Digit Supplements      | 7-8           |
| RD              | Disable Transmission EAN/JAN Number System Digit      | 7-9           |
| RE              | Enable Transmission EAN/JAN Number System Digit       | 7-9           |
| RF              | Disable Transmission EAN/JAN Check Digit              | 7-9           |
| RG              | Enable Transmission EAN/JAN Check Digit               | 7-9           |
| PA              | Disable Interleaved 2 of 5                            | 7-10          |
| PB              | Enable Interleaved 2 of 5 without Check Digit         | 7-10          |
| PC              | Enable Interleaved 2 of 5 with Check Digit            | 7-10          |
| PD              | Set Minimum Length for Interleaved 2 of 5 Labels      | 7-11          |
| PE              | Set Maximum Length for Interleaved 2 of 5 Labels      | 7-11          |

**Symbology Parameters (continued)**

| <b>Mnemonic</b> | <b>Function</b>                                    | <b>Page #</b> |
|-----------------|--|---------------|
| PF              | Disable Standard 2 of 5                            | 7-12          |
| PG              | Enable Standard 2 of 5                             | 7-12          |
| PH              | Set Minimum Length for Standard 2 of 5 Labels      | 7-12          |
| PI              | Set Maximum Length for Standard 2 of 5 Labels      | 7-12          |
| TA              | Disable Code 128                                   | 7-13          |
| TB              | Enable Code 128                                    | 7-13          |
| TC              | Set Minimum Length for Code 128 Labels             | 7-13          |
| TD              | Set Maximum Length for Code 128 Labels             | 7-13          |
| VA              | Disable Codabar                                    | 7-14          |
| VB              | Enable Codabar                                     | 7-14          |
| VC              | Disable Transmission Codabar Start/Stop Characters | 7-14          |
| VD              | Enable Transmission Codabar Start/Stop Characters  | 7-14          |
| VE              | Set Minimum Length for Codabar Labels              | 7-15          |
| VF              | Set Maximum Length for Codabar Labels              | 7-15          |

**AIM:** Acronym for Automatic Identification Manufacturers.

**alphanumeric:** The character set containing letters, numbers, punctuation marks, and symbols.

**ASCII:** American Standard Code for Information Interchange. It is a seven-bit code with an optional parity bit used to represent alphanumerics, punctuation marks, and control codes.

**bar:** The dark element of a printed symbol.

**bar code:** The parallel bars and spaces found in a bar code symbol.

**bar code density:** The number of characters which can be represented in a linear inch.

**bar code label:** A label that carries a bar code and is suitable to be affixed to an article.

**bar code symbol:** A group of parallel bars that represent a character or group of characters whose spacing is determined by a specific set of rules. In most cases, human readable characters are printed below the bars.

**bar length:** The bar dimension perpendicular to the bar width.

**bar width:** The thickness of a bar measured from the edge closest to the symbol's start character to the trailing edge of the same bar.

**character:** A single group of bars and spaces representing an individual number, letter or punctuation mark. A graphic shape representing a letter, number or symbol.

**check digit:** A digit included within a symbol whose value is based mathematically on other characters included in the symbol. It is used to mathematically check the accuracy of a symbol.



**clear area:** A clear space, containing no dark marks, that precedes the start character of a symbol and follows the stop character.

**Codabar:** A numeric symbology consisting of 16 data characters and 4 start/stop characters. Codabar is primarily used by the medical community.

**Code 128:** A symbology representing the full 128 ASCII character set. Numeric data may be represented in a double density mode where two digits are represented by one character.

**Code 39:** An alphanumeric symbology recognized by most nations, widely used in the manufacturing industry.

**code type:** See symbology.

**decode:** The process of translating a bar code into data characters using a specific set of rules for each symbology.

**decoder:** A device used to decode, or make usable, a digital or analog signal transmitted from a scanning device. The scanner contains a decoder.

**EAN:** Acronym for European Article Numbering system, the international standard bar code for retail food packages.

**element:** Dimensionally the narrowest width in a character, bar or space.

**encoded area:** The total linear dimension consisting of all the characters of a code pattern, including start/stop characters and data.

**guard bars:** Bars at the ends and center of a UPC and EAN symbol. They ensure a complete scan of the bar code.

**hex:** Abbreviated form of the word hexadecimal. See hexadecimal.

**hexadecimal:** A base-16 numbering system that uses the symbols 0, 1, 2, 3, 4, 5, 6, 7, 8, 9, A, B, C, D, E, F.

**horizontal bar code:** A bar code or symbol presented in a manner that its overall length dimension is parallel to the horizon. The bars look like a picket fence.

**Interleaved 2 of 5:** A symbology in which characters are paired together using bars to represent odd number characters and spaces to represent even number characters.

**ladder orientation:** See vertical bar code.

**modulus 43 check character:** Used in Code 39 for data security in addition to the builtin self-checking characters. The check-character is the modulus 43 sum of all of the character values in a given message and is the last character in the code.

**orientation:** The alignment of bars and spaces to the scanner. Often referred to as vertical (ladder) or horizontal (picket fence).

**parity bit:** An additional non-data bit attached to a binary word to provide a check of the data integrity by making the sum of the number of ones in a word always even or odd.

**picket fence code:** See horizontal bar code.

**scan:** The search for a symbol or marks which are to be optically recognized.

**scan area:** The area intended to contain a bar code symbol.

**scanner:** A device that optically scans bar code symbols and converts the optical information into digital or analog form and sends it to a decoder.

**self-checking:** A bar code or symbol using a checking algorithm which can be applied to each character to guard against undetected errors. Codes that are not self-checking may employ a check digit or other redundancy in addition to the data message.

**space:** The lighter element of a bar code formed by the background between bars.

**start/stop characters:** Bar code characters that provide the scanner with information on how the code is bounded and its orientation. The start character is normally at the left end of a horizontal code and adjacent to the most significant character. The stop character is normally at the end of a horizontal code and adjacent to the least significant character.

**symbology:** The conventions, or rules, which govern the formation of characters and strings in bar codes. The language of the bar code symbol.

**symbol density:** The number of characters per linear inch.

**symbol length:** The length of the symbol measured from the beginning of the quiet area adjacent to the start character to the end of the quiet area adjacent to a stop character.

**UPC:** Acronym for Universal Product Code. The standard bar code for retail food packages in the United States.

**vertical bar code:** A code pattern in which the overall coded area from start to stop is perpendicular to the horizon. The individual bars appear as rungs of a ladder.

**wedge interface:** A programmable device with resident memory capable of translating scanned bar code data so that it appears that the data was manually entered on a keyboard.

**A**

- Accessories, 2–6
- Autosense Mode, 2–2
  - disable, 5–7
  - enable, 5–7
  - installing autostand, C–1

**B**

- Bar Code Test Symbols, A–1
- Beep, 3–7
- Beeper Operation, 5–4

**C**

- Cables
  - scanner interface, 4-2
  - wedge interface, 2–6, 4-4
- Capture Count, 5–5
- Codabar
  - disable, 7–14
  - enable, 7–14
  - maximum length, 7–15
  - minimum length, 7–15
  - start/stop characters, 7–14
- Code 128
  - disable, 7–13
  - enable, 7–13
  - maximum length, 7–13
  - minimum length, 7–13
- Code 39
  - enable, 7–2
  - maximum length, 7–4
  - minimum length, 7–4
  - modulo 43 check character, 7–3
  - start/stop characters, 7–3

- Code Identifier, 6–5
- Continuous Full Power, 5–3, 8–1

**D**

- Digit Selection Symbols, B–1

**E**

- EAN/JAN
  - check digit, 7–9
  - disable, 7–8
  - enable with or without supplements, 7–8
  - number system digit, 7–9
- Enabling Wedge Mode, 4–6

**F**

- Factory Default Settings, 4–10

**G**

- General Setup Parameters, 2–3, 5–1
  - autosense mode, 5–7
  - beeper operation, 5–4
  - capture count, 5–5
  - power consumption, 5–3
  - spotter beam, 5–6
  - system status, 5–1
- Good Read Indicator, 3–2

## H

Hand-Held Mode, 2–2

## I

Inspecting Cables, D–1

Interface cable

connecting, 4–2

removing, 4–3

Interleaved 2 of 5

enable with or without

check digit, 7–10

maximum length, 7–11

minimum length, 7–11

## K

Keyboard Wedge Interface, 2–1

installing, 4–1

Keyboard Wedge Parameters, 2–3

## L

LED Indicators, 3–2

Good Read, 3–2

Scanning, 3–2

## M

Maintenance

cleaning scanner window, D–1

inspecting cables, D–1

Message Format, 6–1

Message Format Parameters, 2–4,  
6–1

code identifier, 6–5

prefix, 6–2

scanner identifier, 6–4

suffix, 6–3

## O

Operating Modes

autosense mode, 2–2

hand-held mode, 2–2

Operating Ranges, 3–4

Operating Scanner, 3–6

## P

Parameters, F–1

general setup, 2–3

keyboard wedge, 2–3

message format, 2–4

symbolologies, 2–4, 7–1

Postamble, 6–6, 6–7

Power Consumption

continuous full power, 5–3, 8–1

standby power, 5–3, 8–1

while scanning, 8–1

Power Supply, connecting, 4–5

Preamble, 6–6, 6–7

Prefix, 6–2

## R

Resetting Factory Defaults, 4–12

## S

Safety Labels, 3–3

Scanner Identifier, 6–4

Scan Rate, 3–2, 8–1

Scanner

- as a keyboard wedge interface, 2–1
- beep, 3–7
- beeper operation, 5–4
- configuration, 4–8
- description of, 2–1, 3–1
- factory default settings, 4–10
- LED Indicators, 3–2
- operating ranges, 3–4
- operation of, 3–6
- power consumption, 5–3
- safety labels, 3–3
- scan rate, 3–2, 8–1
- specifications, 8–1
- troubleshooting, 3–8
- visible laser diode, 3–1

Scanner Configuration Guidelines,  
4–8

Scanning Indicator, 3–2

Scanning Ranges, 3–4

Scanning Tips, 3–7

Selecting Terminal Type, 4–6

Setup

- connecting power supply, 4–5
- connecting scanner cable, 4–2
- connecting wedge cable, 4–4
- enabling wedge mode, 4–6

- installing wedge interface, 4–1
- selecting terminal type, 4–6
- terminal powerup sequence, 4–5

Specifications

- certification, 8–2
- electrical, 8–1
- environmental, 8–2
- mechanical, 8–2
- optical, 8–1

Spotter Beam

- disable, 5–6
- enable, 5–6

Standard 2 of 5

- disable, 7–12
- enable, 7–12
- maximum length, 7–12
- minimum length, 7–12

Standby Power, 5–3, 8–1

Suffix, 6–3

Symbologies, 2–4

- Codabar, 7–14
- Code 128, 7–13
- Code 39, 7–1
- EAN/JAN, 7–8
- Interleaved 2 of 5, 7–10
- label lengths, 7–1
- Standard 2 of 5, 7–12
- UPC(A and E), 7–5

System Status

- current parameter settings, 5–1
- program ID, 5–2
- version number, 5–2

## T

- Transmit Program ID, 5–2
- Terminal Types, 2–6, 4–6, 4– 10
- Transmit Version Number, 5–2
- Troubleshooting, 3–8

## U

- UPC (A and E)
  - check digit, 7–6
  - enable with/without
    - supplements, 7-5
  - expanded UPC-E, 7–5
  - number system character, 7–6
  - UPC to EAN translation, 7–7

## W

- Wedge Mode
  - enabling, 4–6
  - selecting terminal type, 4–6

