

Connection Systems

Cordsets, DC Micro Style



4-Pin DC Micro Cordset

Specifications

Coupling Nut	Epoxy-coated zinc
Connector	Molded oil-resistant polyurethane body
Contacts	Gold over nickel-plated brass
Cable	Yellow oil-resistant PVC jacket, 18AWG or 22AWG conductors, 300V, UL recognized and CSA certified
Cable O.D.	4/c = 5mm (0.21in) 5/c = 6.5mm (0.25in) 4/c (18AWG) = 6.5mm (0.25in)
Temperature	-20°C to +105°C (-4°F to +221°F)

Features

- Ratcheting coupling nut (on 4-pin DC cordsets)
- Highly visible yellow PVC jacket offers good oil and chemical resistance
- UL recognized and CSA certified

Dimensions—mm (in)

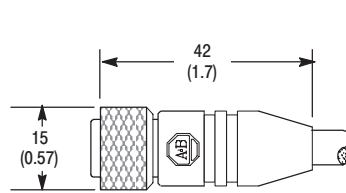

Straight Female

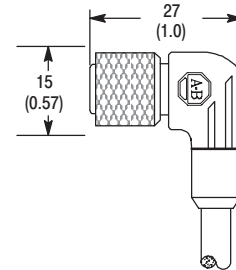

Right Angle Female

Dimensions are approximate. Illustrations are not drawn to scale.

Product Selection

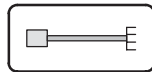

Female Connector (Sensor End)		Cable			Catalog Number
Face View of Female	Connector Style	Wire Color	Wire Rating	Length—m (ft)	
	Straight	1 Brown 2 White 3 Blue 4 Black	22AWG 300V 3A	2 (6.5)	889D-F4AC-2
				5 (16.4)	889D-F4AC-5
				10 (32.8)	889D-F4AC-10
	Right Angle			2 (6.5)	889D-R4AC-2
				5 (16.4)	889D-R4AC-5
				10 (32.8)	889D-R4AC-10
	Straight		18AWG 300V 3A	2 (6.5)	889D-F4AE-2
				5 (16.4)	889D-F4AE-5
10 (32.8)		889D-F4AE-10			
Right Angle	2 (6.5)	889D-R4AE-2			
	5 (16.4)	889D-R4AE-5			
	10 (32.8)	889D-R4AE-10			
	Straight	1 Brown 2 White 3 Blue 4 Black 5 Grey	22AWG 300V 3A	2 (6.5)	889D-F5AC-2
				5 (16.4)	889D-F5AC-5
				10 (32.8)	889D-F5AC-10
	Right Angle			2 (6.5)	889D-R5AC-2
				5 (16.4)	889D-R5AC-5
				10 (32.8)	889D-R5AC-10

Note: For optional stainless steel coupling nuts, add "S" to bulletin number (e.g., 889DS-F4AC-2).

Allen-Bradley HMIs



4-Pin DC Micro Cordset

Specifications

Coupling Nut	Epoxy-coated zinc
Connector	Molded oil-resistant polyurethane body
Contacts	Gold over nickel-plated brass
Cable	Black oil-resistant PVC jacket, 22AWG conductors, 300V, UL recognized and CSA certified
Cable O.D.	2/c = 5mm (0.21in) 4/c = 5mm (0.21in) 5/c = 6.5mm (0.25in)
Temperature	-20°C to +105°C (-4°F to +221°F)

Features

- Ratcheting coupling nut
- Standard black PVC jacket offers good oil and chemical resistance
- 2-wire configuration for use with Allen-Bradley QuadroPlex sensors

Dimensions—mm (in)

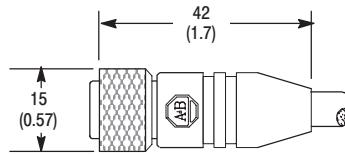

Straight Female

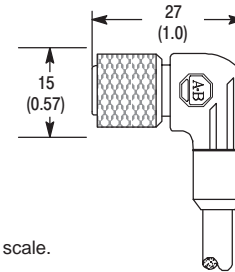

Right Angle Female

Dimensions are approximate. Illustrations are not drawn to scale.

Product Selection

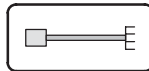

Female Connector (Sensor End)		Cable			Catalog Number
Face View of Female	Connector Style	Wire Color	Wire Rating	Length—m (ft)	
	Straight	1 Brown 2 N/C 3 N/C 4 Blue	22AWG 300V 3A	2 (6.5)	889D-F2BC-Q2
				5 (16.4)	889D-F2BC-Q5
				10 (32.8)	889D-F2BC-Q10
	Straight	1 Brown 2 White 3 Blue 4 Black		2 (6.5)	889D-F4BC-2
				5 (16.4)	889D-F4BC-5
				10 (32.8)	889D-F4BC-10
	Right Angle			2 (6.5)	889D-R4BC-2
				5 (16.4)	889D-R4BC-5
				10 (32.8)	889D-R4BC-10
	Straight	1 Brown 2 White 3 Blue 4 Black 5 Grey		2 (6.5)	889D-F5BC-2
				5 (16.4)	889D-F5BC-5
				10 (32.8)	889D-F5BC-10
	Right Angle		2 (6.5)	889D-R5BC-2	
			5 (16.4)	889D-R5BC-5	
			10 (32.8)	889D-R5BC-10	

Note: For optional stainless steel coupling nuts, add "S" to bulletin number (e.g., 889DS-F4BC-2).

Connection Systems

Cordsets, DC Micro Style



4-Pin DC Micro Cordset

Specifications

Coupling Nut	Epoxy-Coated Zinc
Connector	Molded oil-resistant PVC
Contacts	Gold over palladium/nickel
Cable	Yellow oil-resistant PVC jacket, 22AWG conductors, 300V, UL recognized and CSA certified
Outside Diameter	4/c = 6.4mm (0.25in) 5/c = 7.4mm (0.29in)
Braiding	Shield aluminum mylar stranding 26 x #36 (22AWG)
Temperature	-20°C to +105°C (-4°F to +221°F)

Features

- UL recognized and CSA certified
- Heavy-duty reinforcing braiding
- Braiding can be used as a grounded shield to reduce noise
- Highly visible yellow PVC jacket offers good oil and chemical resistance

Dimensions—mm (in)

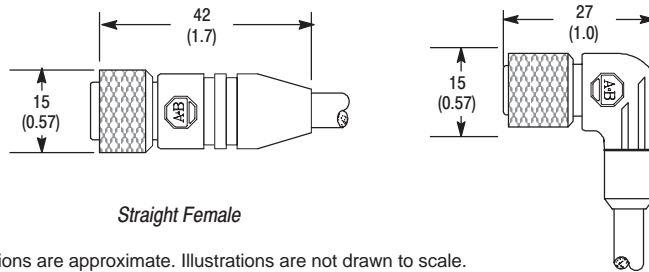

Straight Female

Right Angle Female

Dimensions are approximate. Illustrations are not drawn to scale.

Product Selection

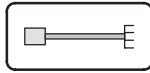

Female Connector (Sensor End)		Cable			Catalog Number
Face View of Female	Connector Style	Wire Color	Wire Rating	Length—m (ft)	
	Straight	1 Brown 2 White 3 Blue 4 Black	Braided 22AWG 300V 3A	2 (6.5)	889D-F4EC-2 ①
				5 (16.4)	889D-F4EC-5 ①
				10 (32.8)	889D-F4EC-10 ①
	Right Angle			2 (6.5)	889D-R4EC-2 ①
				5 (16.4)	889D-R4EC-5 ①
				10 (32.8)	889D-R4EC-10 ①
	Straight	1 Brown 2 White 3 Blue 4 Black 5 Grey	2 (6.5)	889D-F5EC-2 ①	
			5 (16.4)	889D-F5EC-5 ①	
			10 (32.8)	889D-F5EC-10 ①	

① Cable is wire braided for increased strength and abrasion resistance.

Note: For optional stainless steel coupling nuts, add "S" to bulletin number (e.g., 889DS-F4EC-2).

Allen-Bradley HMIs



4-Pin DC Micro Cordset

Specifications

Coupling Nut	Epoxy-Coated Zinc
Connector	Molded oil-resistant PVC
Contacts	Gold-plated palladium/nickel
Cable	Oil-resistant yellow PVC jacket, 20AWG stranded copper, 300V, UL recognized and CSA certified
Cable O.D.	7.1 mm (0.28in)
Temperature	-20°C to +105°C (-4°F to +221°F)

Features

- UL recognized and CSA certified
- Coil provides retractable cable for moving applications
- Highly visible yellow PVC jacket offers good oil and chemical resistance
- One-piece molded body design

Dimensions—mm (in)

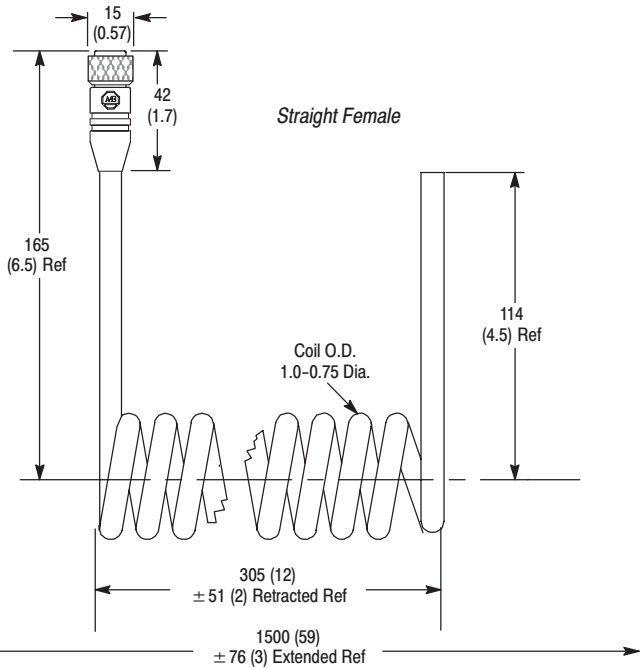

Dimensions are approximate. Illustrations are not drawn to scale.

Product Selection

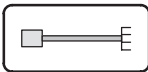

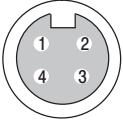
Female Connector (Sensor End)		Cable			Catalog Number
Face View of Female	Connector Style	Wire Color	Wire Rating	Length—m (ft)	
	Straight	1 Brown 2 White 3 Blue 4 Black	20AWG 300V 4A	1.5 (5)	889D-F4AD-C5F



4-Pin DC Micro Illuminated Cordset

Features

- UL recognized and CSA certified
- LED power and output indicators for both PNP and NPN output
- Highly visible yellow PVC jacket offers good oil and chemical resistance

Specifications

Coupling Nut	Epoxy-Coated Zinc
Connector	Molded oil-resistant PVC
Contacts	Gold plated palladium/nickel
Cable	Oil-resistant PVC jacket, 22AWG conductors, 300V, UL recognized and CSA certified
Cable O.D.	5mm (0.21in)
Temperature	-20°C to +105°C (-4°F to +221°F)
Operating Voltage	10-30V DC

Dimensions—mm (in)

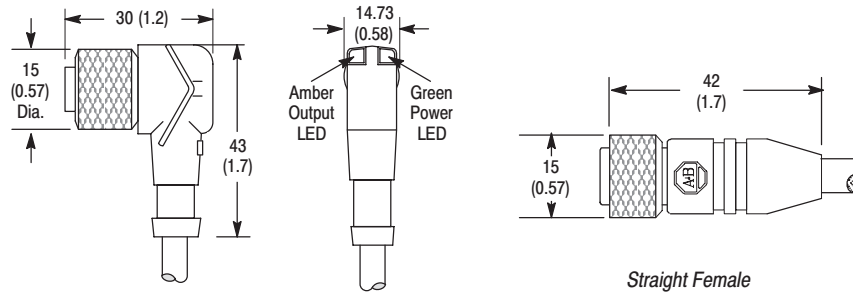

Right Angle Female

Straight Female

Dimensions are approximate. Illustrations are not drawn to scale.

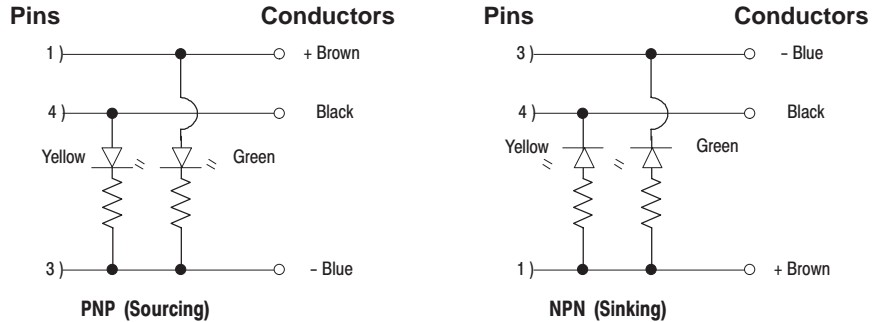

Product Selection

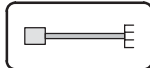

Female Connector (Sensor End)		Cable			LED	Catalog Number
Face View of Female	Connector Style	Wire Color	Wire Rating	Length—m (ft)	Output Style	
	Straight with LED	1 Brown 2 Not Used 3 Blue 4 Black	22AWG 300V 3A	2 (6.5)	PNP	889D-B4AC-2
					NPN	889D-A4AC-2
				5 (16.4)	PNP	889D-B4AC-5
					NPN	889D-A4AC-5
	Right Angle with LED			2 (6.5)	PNP	889D-P4AC-2
					NPN	889D-N4AC-2
				5 (16.4)	PNP	889D-P4AC-5
					NPN	889D-N4AC-5
10 (32.8)	PNP	889D-P4AC-10				
	NPN	889D-N4AC-10				

Note: PNP cable used with PNP sensor output.
 NPN cable used with NPN sensor output.



4-Pin DC Micro Cordset

Specifications

Coupling Nut	Epoxy-coated zinc
Connector	Molded oil-resistant santoprene body
Contacts	Gold over nickel-plated brass
Cable Approvals	Allen-Bradley ToughLink TPE yellow jacket, 22AWG conductors, 600V UL recognized and CSA certified
Cable O.D.	8mm (0.32in)
Temperature	-40°C to +105°C (-40°F to +221°F)

Features

- Ratcheting coupling nut for vibrating resistance
- ToughLink TPE yellow jacket offers excellent oil and chemical resistance
- Heavy duty construction for rugged environments
- UL recognized and CSA certified

Dimensions—mm (in)

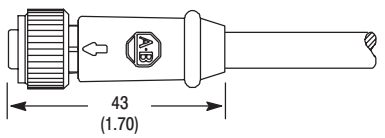

Straight Female

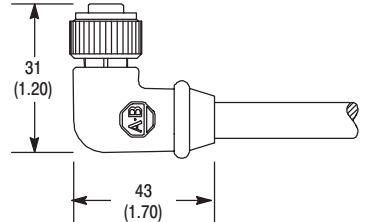

Right Angle Female

Dimensions are approximate. Illustrations are not drawn to scale.

Product Selection

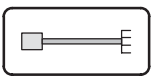

Female Connector (Sensor End)		Cable			Catalog Number
Face View of Female	Connector Style	Wire Color	Wire Rating	Length—m (ft)	
	Straight	1 Brown 2 White 3 Blue 4 Black	22AWG 300V 3A	2 (6.5)	889D-F4HC-2
				5 (16.4)	889D-F4HC-5
				10 (32.8)	889D-F4HC-10
	Right Angle			2 (6.5)	889D-R4HC-2
				5 (16.4)	889D-R4HC-5
				10 (32.8)	889D-R4HC-10

Cordsets, DC Micro Style

Female, ToughWeld™ Neoprene Rubber Jacket



4-Pin DC Micro Cordset

Specifications

Coupling Nut	Epoxy-coated zinc
Connector	Molded oil-resistant PVC
Contacts	Gold over nickel-plated brass
Cable Approvals	SJOOW ToughWeld neoprene rubber jacket, 18AWG conductors, 300V UL recognized and CSA certified
Cable O.D.	9mm (0.35in)
Temperature	-20°C to +90°C (-4°F to +194°F)

Features

- Durable SJOOW 18AWG cable
- Highly visible yellow ToughWeld neoprene rubber jacket offers excellent weld slag resistance
- Ratcheting coupling nuts for vibration resistance

Dimensions—mm (in)

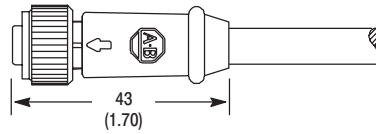

Straight Female

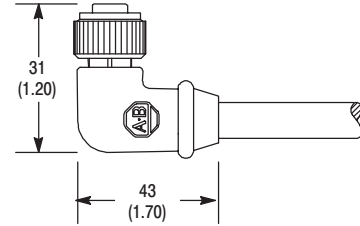

Right Angle Female

Product Selection

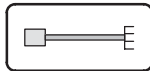

Dimensions are approximate. Illustrations are not drawn to scale.

Female Connector (Sensor End)		Cable			Catalog Number
Face View of Female	Connector Style	Wire Color	Wire Rating	Length—m (ft)	
	Straight	1 Brown 2 White 3 Blue 4 Black	18AWG 300V 3A	2 (6.5)	889D-F4WE-2
				5 (16.4)	889D-F4WE-5
				10 (32.8)	889D-F4WE-10
	Right Angle			2 (6.5)	889D-R4WE-2
				5 (16.4)	889D-R4WE-5
				10 (32.8)	889D-R4WE-10



Specifications

Coupling Nut	Epoxy-Coated Zinc
Connector	Molded oil-resistant PVC
Contacts	Gold-plated palladium/nickel
Cable Cable Approvals	Black TPR jacket, 24AWG conductors, 300V UL recognized and CSA certified
Cable O.D.	5mm (0.21in)
Enclosure Rating	IP67, NEMA 6P
Temperature	-25°C to +125°C (-13°F to +256°F)

Features

- Durable high temperature cable
- 8-pin/7-wire configuration for Sipha safety switches and other applications
- Ratcheting coupling nuts for vibration resistance

Dimensions—mm (in)

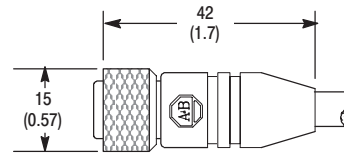

Straight Female

Dimensions are approximate. Illustrations are not drawn to scale.

Product Selection

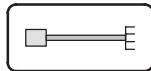

Female Connector (Sensor End)		Cable			Catalog Number
Face View of Female	Connector Style	Wire Color	Wire Rating	Length—m (ft)	
	Straight	1 Red 2 Blue 3 Green 4 Yellow 5 Black 6 White 7 N.C. 8 Grey	24AWG 300V AC/36V DC 1.5A	2 (6.5)	889D-F8AC-2
				5 (16.4)	889D-F8AC-5
				10 (32.8)	889D-F8AC-10
				15 (49.2)	889D-F8AC-15
				20 (65.6)	889D-F8AC-20
				30 (98.4)	889D-F8AC-30

Cordsets, DC Micro Style

8-Pin/8-Wire



8-Pin DC Micro Cordset

Specifications

Coupling Nut	Epoxy-Coated Zinc
Connector	Molded oil-resistant PVC
Contacts	Gold-plated palladium/nickel
Cable Cable Approvals	Black PUR jacket, 24AWG conductors, 300V UL recognized and CSA certified
Cable O.D.	5mm (0.21in)
Enclosure Rating	IP67, NEMA 6P
Temperature	-20°C to +85°C (-4°F to +185°F)

Features

- 8-pin/8-wire configuration for GuardShield light curtains and other applications
- Ratcheting coupling nuts for vibration resistance

Dimensions—mm (in)

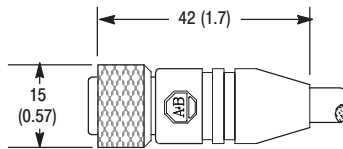

Straight Female

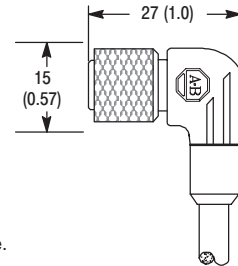

Right Angle Female

Dimensions are approximate. Illustrations are not drawn to scale.

Product Selection

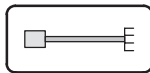

Female Connector (Sensor End)		Cable			Catalog Number
Face View of Female	Connector Style	Wire Color	Wire Rating	Length—m (ft)	
	Straight	1 White 2 Brown 3 Green 4 Yellow 5 Grey 6 Pink 7 Blue 8 Red	24AWG 300V AC/36V DC 1.5A	2 (6.5)	889D-F8AB-2
				5 (16.4)	889D-F8AB-5
				10 (32.8)	889D-F8AB-10
				15 (49.2)	889D-F8AB-15
				20 (65.6)	889D-F8AB-20
				30 (98.4)	889D-F8AB-30
	Right Angle			2 (6.5)	889D-R8AB-2
				5 (16.4)	889D-R8AB-5
				10 (32.8)	889D-R8AB-10
				15 (49.2)	889D-R8AB-15
				20 (65.6)	889D-R8AB-20
				30 (98.4)	889D-R8AB-30