

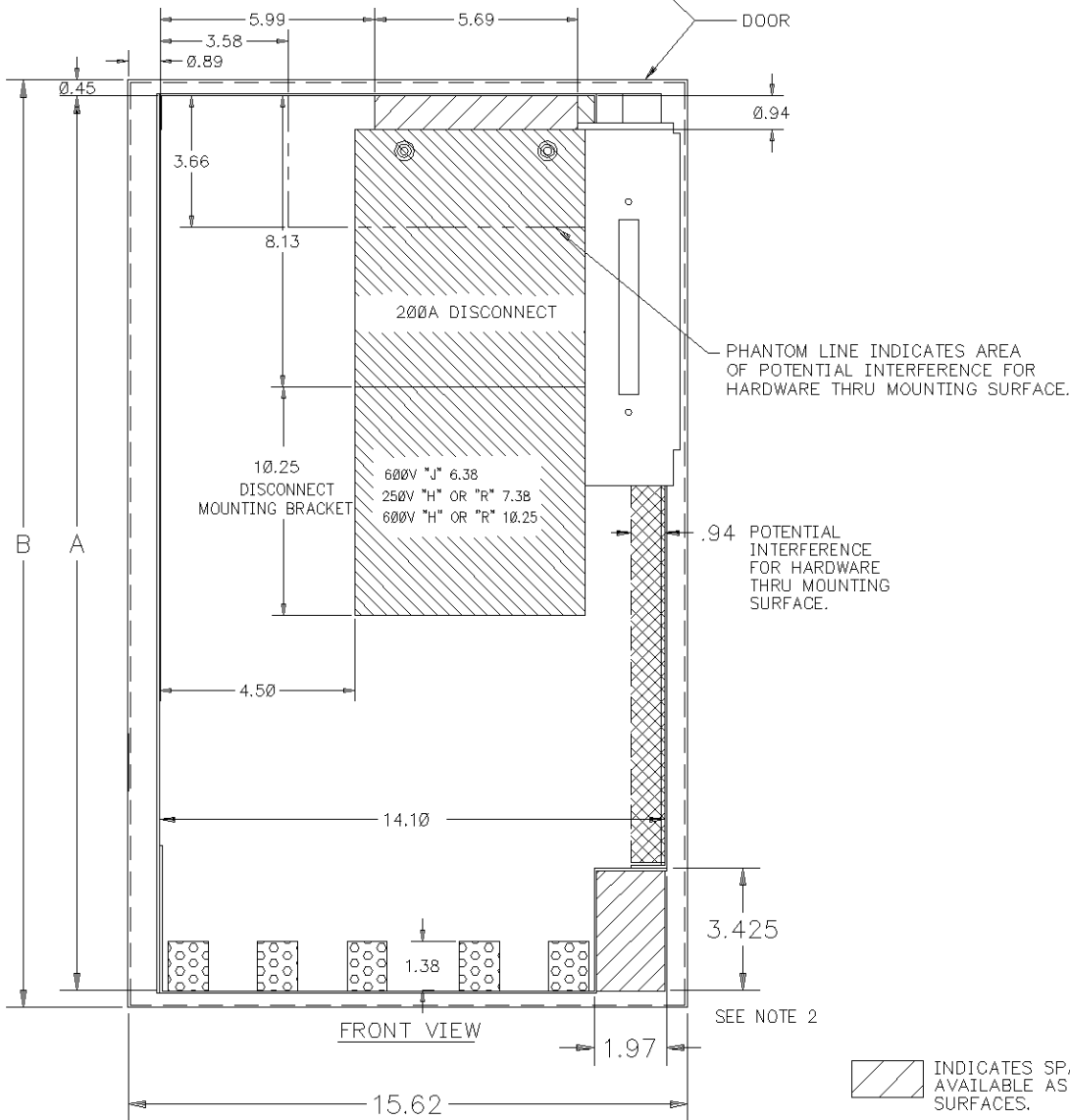

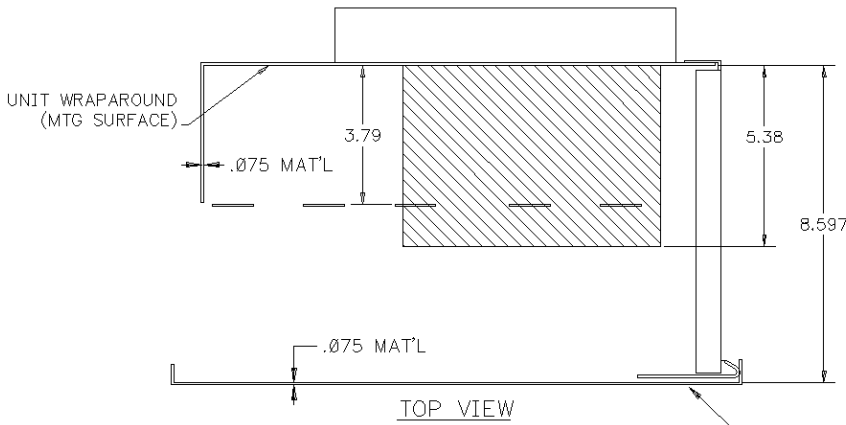

- NOTE: (1) DIMENSIONS ARE NOT FOR MANUFACTURING PURPOSES.
- (2) TERMINAL BLOCK MOUNTING TABS ARE ONLY SUPPLIED WHEN OPTIONS -800 TO -805 ARE SPECIFIED. TABS ACCOMMODATE PART NUMBER 1492-EC85 (5 POLE) AND 1492-ED103 (3 POLE) TERMINAL BLOCKS.



-  INDICATES SPACE NOT AVAILABLE AS MOUNTING SURFACES.
-  INDICATES POTENTIAL INTERFERENCE FOR HARDWARE THRU MOUNTING SURFACE.
-  INDICATES POTENTIAL INTERFERENCE FROM TABS FORWARD OF MOUNTING SURFACE.
-  INDICATES SPACE REQUIRED FOR DISCONNECT SWITCH

2100D UNIT INSERT W/200A DISC SWITCH (SEE NOTE 2)	4	51.12	51.906
	3.5	44.62	45.406
	3	38.12	38.906
	2.5	31.62	32.406
	2	25.12	25.906
	SPACE FACTOR	DIM A	DIM B

References		Dimensions Apply Before Surface Treatment
Revision	Release	
1	11900-06	Dimensions in Inches Tolerances Unless Otherwise Specified 2 Place Decimal ±.02 3 Place Decimal ±.005 Angles ±1°
Refer. Book		

DIMENSION DRAWING	
FOR 2100D UNIT INSERT	
W/200A DISCONNECT SWITCH	
250V OR 600V "H-R" OR "J" FUSE	
Dr. Jim Kelly	Date 2-9-06
Chkd. JIM KELLY	Date 4-18-06
Appd. T. SAUVE	Date 4-18-06

THIS PART	REV. LTR.
-01	1
	
<small>CONFIDENTIAL AND PROPRIETARY INFORMATION. THIS DOCUMENT CONTAINS CONFIDENTIAL AND PROPRIETARY INFORMATION OF ROCKWELL AUTOMATION, INC. AND MAY NOT BE USED, COPIED OR DISCLOSED TO OTHERS EXCEPT WITH THE AUTHORIZED WRITTEN PERMISSION OF ROCKWELL AUTOMATION, INC.</small>	
Sheet	1 Of 1
Dwg Size	C
30101-541	

PARTS MUST CONFORM TO APPLICABLE ALLEN-BRADLEY CO. WORKMANSHIP STANDARD 40126-700